

HUGO GERNSBACK, *Editor*

# RADIO CRAFT

1907

1947

De Forest Anniversary Number

40 Years of the Vacuum Tube

*Lee de Forest.*



JAN

1947

50¢

CANADA 60¢

RADIO-ELECTRONICS IN ALL ITS PHASES



hallicrafters PRESENTS THE

# SX-42

**Another first!  
Greatest contin-  
uous frequency  
coverage of any  
communications  
receiver — from  
540 kc to 110 Mc**

This is the long-awaited Hallicrafters SX-42, a truly great communications receiver. The tremendous frequency range of the SX-42, *greater than ever before available in a receiver of this type*, is made possible by the development of a new "split-stator" tuning system and the use of dual intermediate frequency transformers. Packed with advance features that every ham and every other radio enthusiast desires, the SX-42 clearly lives up to the Hallicrafters ideal of "the radio man's radio."

From now on watch Hallicrafters—the name that's remembered by the veteran, preferred by the radio amateur. See your distributor for demonstration of the SX-42 and for colorful literature describing this great set in complete technical detail.

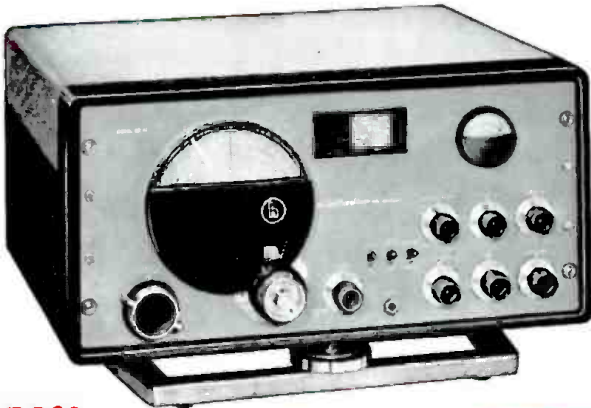

*Because of the precise and thorough engineering that must be done on the SX-42 and because the parts supply has not been continuous, top production peaks have not yet been reached. In the immediate future deliveries will necessarily run behind the demand, but the SX-42 is definitely worth waiting for.*

**\$250<sup>00</sup>**  
**Amateur Net**

Adjustable Base  
for "eye-angle"  
tuning No. B-42  
\$7.50 (O.P.A. Approved)



**hallicrafters RADIO**

THE HALLICRAFTERS CO., MANUFACTURERS OF RADIO  
AND ELECTRONIC EQUIPMENT, CHICAGO 14, U.S.A.  
Sole Hallicrafters Representatives in Canada  
Logan's Maritime Limited, Toronto, Ontario

BUILDERS OF *Skyfone* AVIATION RADIOTELEPHONE

 Hallicrafters joins the entire radio industry in congratulations to Lee De Forest . . . without whose ingenuity and inventiveness such advanced communications equipment as the Hallicrafters SX-42 would have been impossible.

SINCERELY, *W. J. Halligan* AND ALL THE HALLICRAFTERS

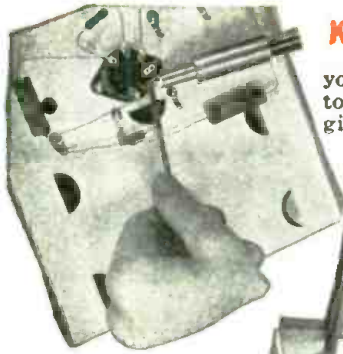

**KIT 1** I send you Soldering Equipment and Radio Parts; show you how to do Radio soldering; how to mount and connect Radio parts; give you practical experience.

**KIT 2** Early in my course I show you how to build this N. R. I. Tester with parts I send. It soon helps you fix neighborhood Radios and earn EXTRA money in spare time.

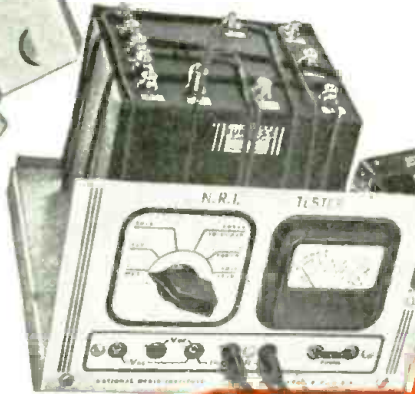

# Be a RADIO Technician

## Learn by PRACTICING in Spare Time

with **BIG KITS** of **RADIO PARTS** I send you

**KIT 3** You get parts to build Radio Circuits; then test them; see how they work; learn how to design special circuits; how to locate and repair circuit defects.

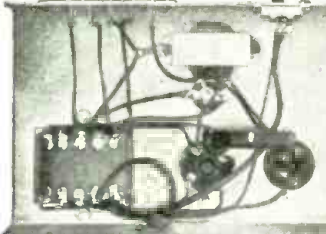
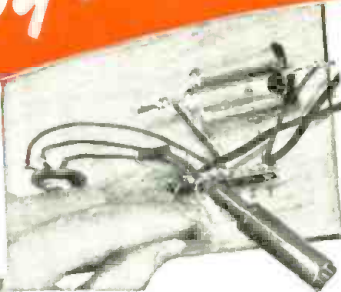

**KIT 4** You get parts to build this Vacuum Tube Power Pack; make changes which give you experience with packs of many kinds; learn to correct power troubles.

**KIT 5** Building this A. M. Signal Generator gives you more valuable experience. It provides amplitude-modulated signals for many tests and experiments.

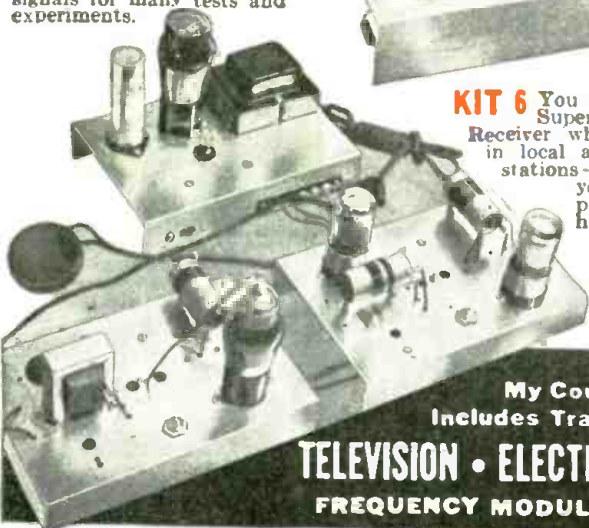
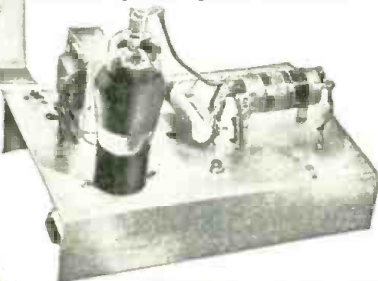

**KIT 6** You build this Superheterodyne Receiver which brings in local and distant stations—and gives you more experience to help you win success in Radio.

My Course Includes Training in **TELEVISION • ELECTRONICS** FREQUENCY MODULATION

APPROVED for training under G.I. BILL

Do you want a good-pay job in the fast-growing Radio Industry—or your own Radio Shop? Mail the Coupon for a Sample Lesson and my 64-page book, "How to Be a Success in Radio—Television, Electronics," both FREE. See how I will train you at home—how you get practical Radio experience building, testing Radio circuits with **BIG KITS OF PARTS** I send!

**Many Beginners Soon Make Extra Money in Spare Time While Learning**

The day you enroll I start sending **EXTRA MONEY JOB SHEETS** that show how to make **EXTRA** money fixing neighbors' Radios in spare time while still learning! It's probably easier to get started now than ever before, because the Radio Repair Business is booming. Trained Radio Technicians also find profitable opportunities in Police, Aviation, Marine Radio, Broadcasting, Radio Manufacturing, Public Address work. Think of even greater opportunities as Television, FM, and Electronic devices become available to the public! Send for **FREE** books now!

**Find Out What NRI Can Do For You**

Mail Coupon for Sample Lesson and my **FREE** 64-page book. Read the details about my Course; letters from men I trained; see how quickly, easily you can get started. No obligation! Just **MAIL COUPON NOW** in envelope or paste on penny postal. **J. E. SMITH, President, Dept. 7AX, National Radio Institute, Pioneer Home Study Radio School, Washington 9, D.C.**

Our 33rd Year of Training Men for Success in Radio

Sample Lesson **FREE**  
64 Page Book

**MR. J. E. SMITH, President, Dept. 7AX National Radio Institute Washington 9, D.C.**

Mail me **FREE**, Sample Lesson and 64-page book about how to win success in Radio—Television, Electronics. (No salesman will call. Please write plainly.)

Age .....

Name .....

Address .....

City ..... State .....

(Please include Post Office zone number)

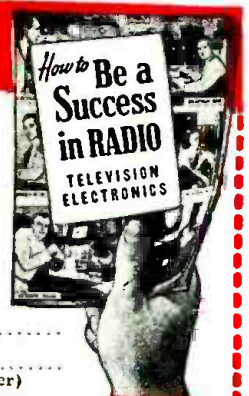

**Approved for Training under GI Bill**



# UNIVIBE... *The Universal Vibrator!*

8 TYPES  
SERVICE  
OVER 2500  
AUTO  
RADIO



## N. U. AUTO RADIO VIBRATORS ARE BUILT FOR ENDURANCE!

1. Welded pole pieces for life-time adjustment accuracy.
2. Snug fitting synthetic sponge insulation for quiet operation.
3. Spot-welding of fingers, in contact against each other and the center reed, reduces voltage drop in center reed assembly.
4. Vibration proof adjustment by means of double-screw stack.
5. Pressure plate on top of stack keeps stack tight under tension over wide ranges of temperature.
6. Extra flexible roped wire leads eliminate strain and weakening.
7. Metal can, spun at bottom, seals vibrator against dust and dirt.
8. Plated pins assure minimum contact resistance.
9. Face of center reed weight is surface-ground to improve magnetic coupling.
10. Center reed uniformly stressed to prevent breakage.
11. Specially tempered reed and side contact arms.
12. Corrosion resistant silver-plated side contact arms.
13. Precision ground bakelite spacers for structural and dimensional stability.
14. Steel ring, molded into shock mount, centers and holds vibrator upright when can is sealed.
15. Neoprene wafer in hermetically sealed vibrators effectively seals vibrator against atmospheric pressure changes and moisture.

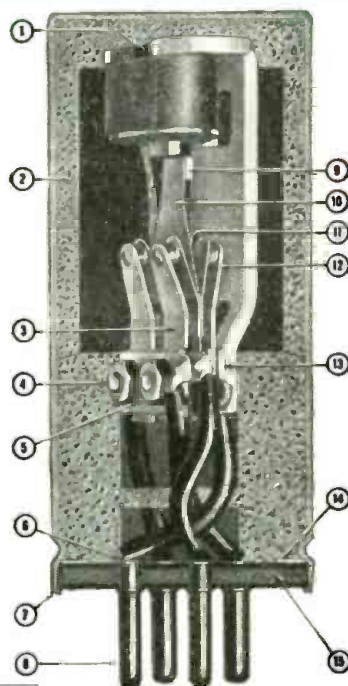

Typical Synchronous Vibrator Construction

## NEW LINE COVERS 97% OF ALL VIBRATOR REPLACEMENTS

UNIVIBE—the complete 8-model vibrator line—covers the replacement needs of over 2500 auto radio models! Provides quick, easy replacement of worn out vibrators in 182 makes of auto radios, as old as 1936!

Think of it—97% service coverage with only 8 fast-moving numbers—every one a repeat profit producer!

Yes, Univibe is right at the top in quality. Well known “balanced resonance” design, of extra heavy duty construction, means 33% longer vibrator life by actual test.

Here is another money-making radio parts line for National Union dealers.

For immediate delivery order Univibes today from your N. U. Distributor.

NATIONAL UNION RADIO CORPORATION, NEWARK 2, N.J.



1907-1947

We salute you,  
Dr. Lee de Forest,  
on the  
40th Anniversary  
of the invention of  
the vacuum tube.

# NATIONAL UNION RADIO, TUBES AND PARTS

Receiving Tubes • Transmitting Tubes • Special Purpose Tubes • Cathode Ray Tubes • Radio Sets • Phototubes  
Panel Lamps • Flashlight Bulbs • Ballasts • Volume Controls • Condensers • Batteries • Auto Vibrators



# Radio Parts are EASY to identify

when you use  
**PHOTOFACT FOLDERS**

**PARTS LIST AND DESCRIPTIONS**

**TUBES**

ITEM No.	TYPE	REPLACE- MENT DATA	MANUFACTURER	REMARKS
1	6X4			
2	6X4			
3	6X4			
4	6X4			
5	6X4			
6	6X4			
7	6X4			
8	6X4			
9	6X4			
10	6X4			

**CAPACITORS**

Capacity values given in the rating column are in mfd. for Electrolytic and Paper Capacitors, and in mmfd. for Mica and Ceramic Capacitors.

ITEM No.	RATING	TRUETONE PART No.	MALLORY PART No.	SOLAR PART No.	SPRAGUE PART No.	AEROVOX PART No.	CORNELL-DUBIER PART No.	IDENTIFICATION CODES AND INSTALLATION NOTES
7(A)	40-150	500256	FP306*	DY-40+20-150	EL-24	AFB8D	UP3515	Filter
8	2-400	502158	TP429	S-4-2	TC-2	484-.2	DT4P2	Line Isolating
9	.05-400	502157	TP426	S-4-05	TC-15	484-.05	DT4S5	Line Filter
10	.01-400	502153	TP421	S-4-01	TC-11	484-.01	DT4S1	Per. Amp. Plate
11	.004-400	502156	TP407	S-5-004	TC-24	484-.004	DT5D4	Audio Coupling

**CONTROLS**

**RESISTORS**

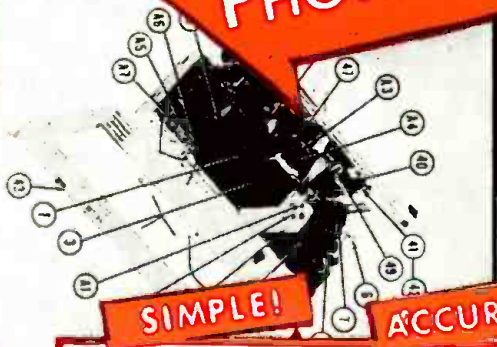

**SIMPLE!**

**ACCURATE!**

**FAST!**

**CAPACITORS**

Capacity values given in the rating column are in mfd. for Electrolytic and Paper Capacitors, and in mmfd. for Mica and Ceramic Capacitors.

ITEM No.	RATING		REPLACEMENT DATA						IDENTIFICATION CODES AND INSTALLATION NOTES
	CAP.	VOLT.	TRUETONE PART No.	MALLORY PART No.	SOLAR PART No.	SPRAGUE PART No.	AEROVOX PART No.	CORNELL-DUBIER PART No.	
7(A)	40-150		500256	FP306*	DY-40+20-150	EL-24	AFB8D	UP3515	Filter
8	2-400		502158	TP429	S-4-2	TC-2	484-.2	DT4P2	Line Isolating
9	.05-400		502157	TP426	S-4-05	TC-15	484-.05	DT4S5	Line Filter
10	.01-400		502153	TP421	S-4-01	TC-11	484-.01	DT4S1	Per. Amp. Plate
11	.004-400		502156	TP407	S-5-004	TC-24	484-.004	DT5D4	Audio Coupling

What's your biggest headache when servicing radios? Identifying parts? With **PHOTOFACT FOLDERS** it's easy to locate and identify any item you want to find. Just look at the Complete Parts List . . . a list that's keyed to clear chassis photographs and a full page, easy-to-read schematic diagram. For instance, the capacitor listing alone gives complete data on capacity, voltage rating, function, replacement types . . . even includes installation notes.

No service problem can stump you when you use **PHOTOFACT FOLDERS**. They result from the actual examination of the receiver involved, and are not copied from the manufacturer's service data or from looking at his schematics. They tell you everything you need to know about any set manu-  
\*Trade Mark Reg.

factured since January 1, 1946—even to the restringing of dial cords. They do this by means of pictures, full-page schematics, *original* technical notes that help you work faster, more accurately...easily increase the number of jobs you can do in a week by fifty percent.

**PHOTOFACT FOLDERS** are sold in sets of 40, each set covering new radios, phonographs, record changers, intercommunication systems, recorders and power amplifiers *within a short time after they reach the market*. Their cost is only \$1.50 a set, including membership in the Howard W. Sams Institute. No other radio service compares with **PHOTOFACT FOLDERS** in completeness, accuracy or timeliness. Use the coupon. *Mail it to your nearest radio parts supply house.*

## In Each PHOTOFACT FOLDER You Get—



1. A cabinet view of the receiver to help you establish identity and control functions.
2. A top view of chassis and speaker to identify component parts and alignment points.
3. A bottom view of chassis and/or accessories.
4. A complete list giving keyed reference to all parts, alignment and schematic diagram.
5. A complete, full-page schematic diagram.
6. Stage gain measurements listed on the schematic diagram.
7. A complete voltage and resistance analysis chart for rapid check of operational values.
8. Complete alignment instructions on the receiver consistent with the keyed alignment points indicated on photographs.
9. Dial cord diagram and restringing instructions.
10. Complete disassembly instructions where required.

### PUBLICATION DATES :

Set No. 9 . . . . . December 19  
Set No. 10 . . . . . December 29

Cut this out and **MAIL IT TO YOUR DISTRIBUTOR**. If you do not know his name and address, send it directly to Howard W. Sams & Co., Inc., 2924 East Washington Street, Indianapolis 6, Indiana, and we will see that your nearest distributor gets it. In Canada—write to A. C. SIMMONDS & SONS, 301 King Street East, Toronto, Ontario. Canadian Price \$1.75.

#### PLEASE PRINT

Send Set No. 10     Send Set No. 9  
(Circle one or more of following) Send Set No. 8, 7, 6, 5, 4, 3, 2, 1 (at \$1.50 a set)

Send me a DeLuxe Binder (at \$3.39)  
My (check) (money order) (cash) for \_\_\_\_\_ is enclosed. (If you send cash, be sure to use registered mail)

Name \_\_\_\_\_

Address \_\_\_\_\_

City \_\_\_\_\_ Zone \_\_\_\_\_ State \_\_\_\_\_

Company Name \_\_\_\_\_

My Distributor's Name \_\_\_\_\_

City \_\_\_\_\_

# HOWARD W. Sams & CO., INC. RADIO PHOTOFACT SERVICE

In Canada—write to A. C. SIMMONDS & SONS, 301 King Street East, Toronto, Ontario



# —thanks

# Dr. De Forest



● Here in glass and metal is the control of the world's greatest force . . . the electron. Here is man's eye to see through solids and beyond horizons . . . to make audible to his ear sounds he otherwise could not hear . . . his voice, to make himself heard around the world . . . his mastery of time, temperatures and motion.

This is the electron tube . . . the heart, the soul, the brain of every electronic device. We thank you, Dr. De Forest, for your invention of nearly a half century ago which is the genesis of the TUNG-SOL Electron Tube of today that serves every domestic, industrial and marine requirement.



**TUNG-SOL LAMP WORKS INC., NEWARK 4, NEW JERSEY**  
Sales Offices: Atlanta • Chicago • Dallas • Denver • Detroit • Los Angeles • New York  
Also Manufacturers of Miniature Incandescent Lamps, All-Glass Sealed Beam Headlight Lamps and Current Intermittors



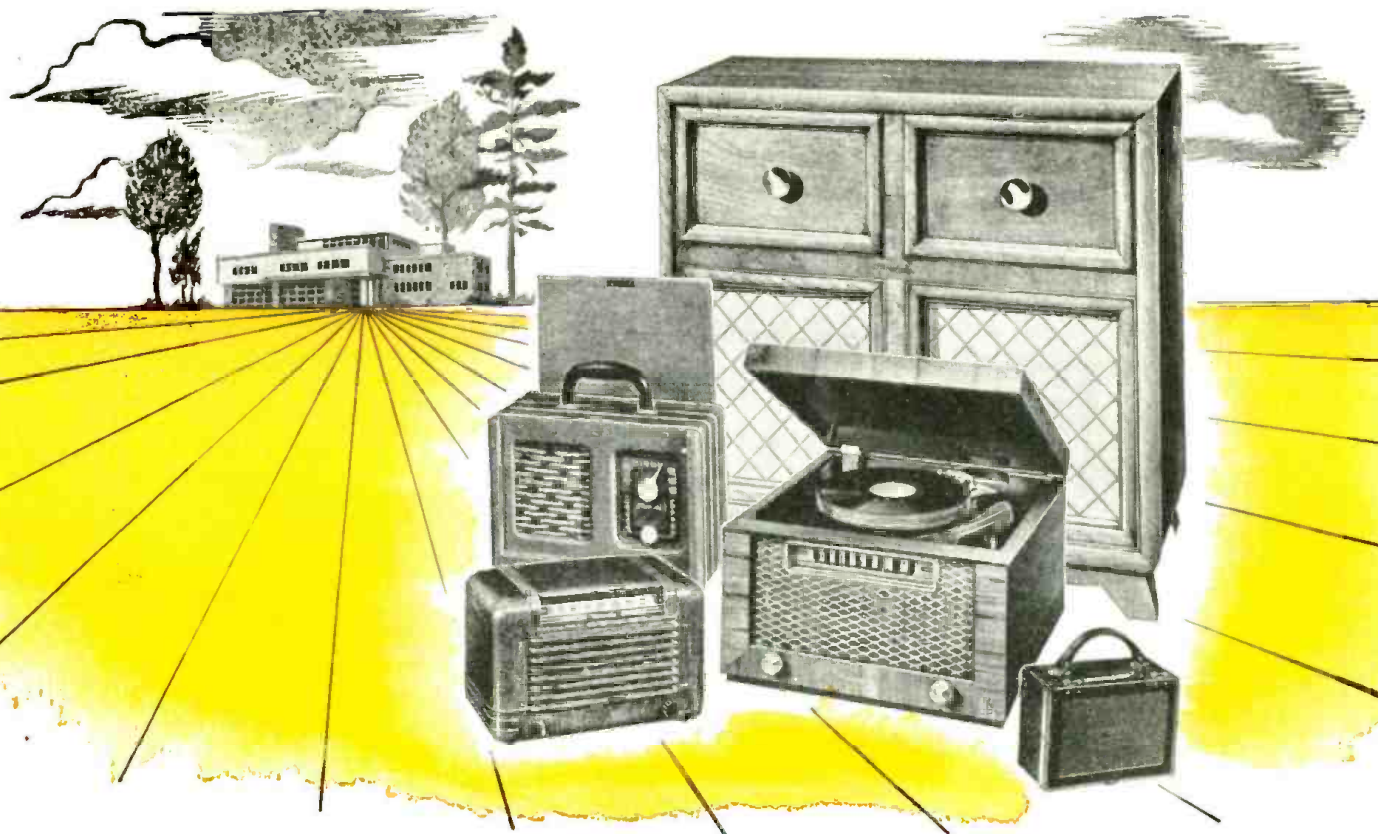

## LISTENERS' CHOICE

*for "Golden Voice" tone - all thru the house*

All who have heard the new Motorolas agree—their exquisite styling is reflected in their gorgeous tone. They live up to the promise of their appearance with performance that matches their beauty. There is a Motorola Radio for *every* room of *every* home—each of them "furniture styled" to harmonize with the most distinctive tastes in interior decorating.

When you first set eyes on them you'll find that here, at last, are radios designed to fulfill the function of fine furniture—and when you *listen* to them you'll agree that *Motorola beauty is more than skin deep*. Look, listen, compare—you too will choose Motorola.





# New!

## Series 200

# A RELAY BY GUARDIAN with Interchangeable Coils

### BUILT IN TWO PARTS

★ Two basic parts—a coil assembly and a contact assembly—comprise this simple, yet versatile relay. The coil assembly consists of the coil and field piece. The contact assembly consists of switch blades, armature, return spring, and mounting bracket. The coil and contact assembly are easily aligned by two locator pins on the back end of the contact assembly which fit into two holes on the coil assembly. They are then rigidly held together with the two screws and lock washers. Assembly takes only a few seconds and requires no adjustment on factory built units.

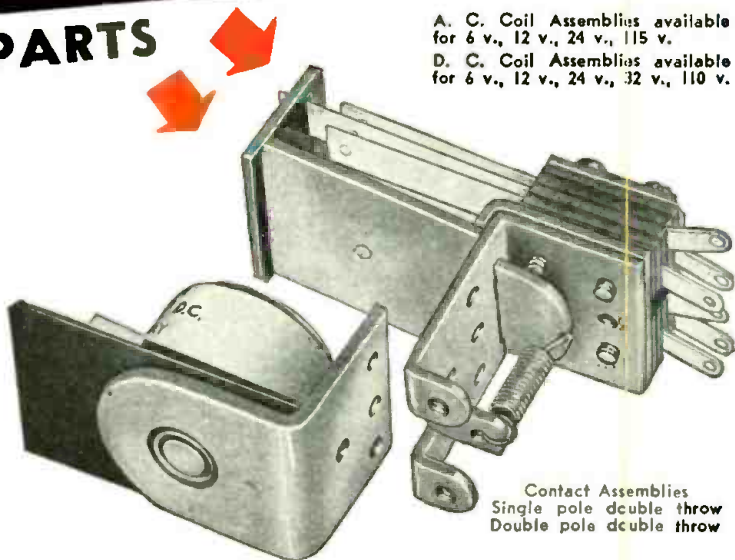

A. C. Coil Assemblies available for 6 v., 12 v., 24 v., 115 v.  
D. C. Coil Assemblies available for 6 v., 12 v., 24 v., 32 v., 110 v.

Series 200 Relay

### Two Contact Assemblies — Nine Coil Assemblies — (Listed Above)

It has always been Guardian's aim throughout the years, to make the best radio relays that enterprise, skill and research could produce. The Series 200 Guardian Relay is such a product. With its *interchangeable* coil and contact assembly feature, it is one of the truly great innovations that radio amateurs and service men have long needed and wanted. It exemplifies the progress Guardian has made in the interest of low-cost, high efficiency, radio relays.

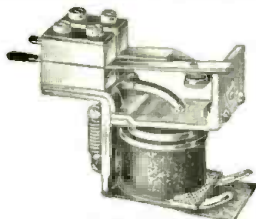

Series R-100  
H. F. Relay

See your Jobber  
Write for Bulletin 200

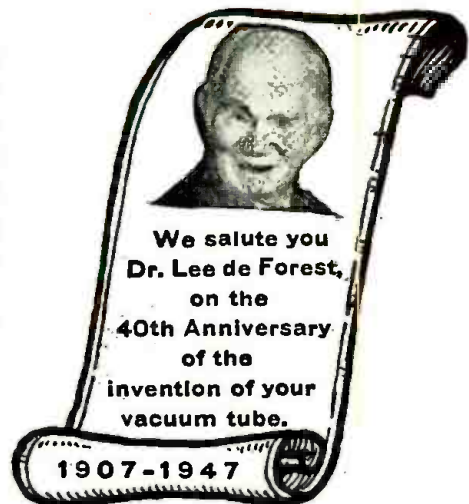

We salute you  
Dr. Lee de Forest,  
on the  
40th Anniversary  
of the  
invention of your  
vacuum tube.

1907-1947

# GUARDIAN ELECTRIC

1641-A W. WALNUT STREET

CHICAGO 12, ILLINOIS

A COMPLETE LINE OF RELAYS SERVING AMERICAN INDUSTRY



# SYLVANIA NEWS

## RADIO SERVICE EDITION

JAN.

Prepared by SYLVANIA ELECTRIC PRODUCTS INC., Emporium, Pa.

1947

### "CARRY THE TUBES THAT BUILD GOODWILL" IS THEME OF SYLVANIA TUBE QUALITY STORY

**SYLVANIA  
SERVICEMAN  
SERVICE**



by  
**FRANK FAX**

Carrying the *complete* line of Sylvania receiving tubes is one of the best ways to build goodwill for your business.

You can be sure of this because of the public's recognition of Sylvania's high quality. Extensive national advertising has helped promote this recognition — and acceptance. QUALITY CONTROL backs up this story of Sylvania quality.

Before Sylvania tubes can be shipped to your distributor, they must first pass a series of stiff tests conducted by an efficient Quality Control Department. Only those tubes that are proved to be electrically and mechanically perfect ever reach you.

Sylvania makes its own tube parts — over forty-five million a month. Even the fine tungsten wire filaments for Sylvania tubes are *Sylvania-made* to safeguard the quality of this vital tube element.

As a result, Sylvania can keep a close check on every tube — from raw materials straight through to the finished product.

Remember the story of Sylvania quality! It is one reason why carrying Sylvania tubes means you will receive a lot extra in the way of *goodwill*.

#### SEE YOUR SYLVANIA DISTRIBUTOR

For full information on the complete line of Sylvania receiving tubes — and the long list of valuable business and technical aids for you — call on your local distributor.

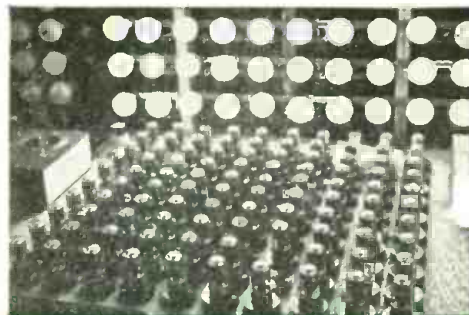

Completed tubes are being "aged" to stabilize characteristics. Then they get continuity, short and noise tests.



Tubes are here being given the Life Test — as another check on design, quality and dependable service.



At the Emporium, Pa. Tube Plant, where pleasant surroundings help keep employees tuned to quality workmanship.

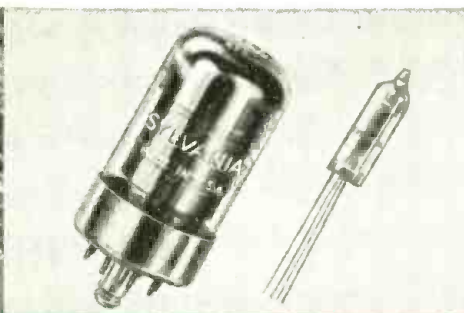

Quality products — the Sylvania Lock-In tube, and the T-3 tube for proximity fuse fame.

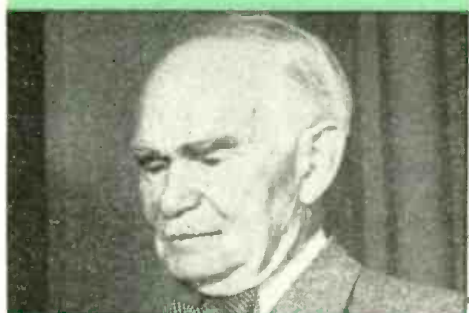

Sylvania congratulates Dr. Lee De Forest on the 40th Anniversary of his inventing the three-element vacuum tube.

# SYLVANIA ELECTRIC

Emporium, Pa.

MAKERS OF RADIO TUBES, CATHODE RAY TUBES, ELECTRONIC DEVICES, FLUORESCENT LAMPS, FIXTURES, WIRING DEVICES, ELECTRIC LIGHT BULBS

# THE TRUSTY TRIO FOR

# *Tough Jobs*



**TURNER  
99**



**TURNER  
999**



**TURNER  
U9S**

Severe operating conditions are a "push-over" for Turner Dynamic mikes. Their accurate pickup and smooth natural response to voice and music is not affected by climate or temperature. Built-in ruggedness enables them to stand up and deliver under abuse that renders an ordinary microphone useless. Typical of Turner Quality are Models 99, 999, and U9S. Professionals both in appearance and performance they will give added efficiency to your operations. Find out more about these Turner Dynamics.

## MODEL 99 DYNAMIC

Used by broadcast stations, large city police departments, and specified as standard equipment by internationally known manufacturers. Will not blast from close speaking. Case fits any standard microphone stand and adjustable saddle gives semi- or non-directional operation. Response is flat within  $\pm 5$ db from 40-9000 cycles. Level: 52db below 1 volt/dyne/sq. cm. at high impedance. Gun metal type finish. Complete with 20 ft. removable cable set in a choice of 30-50 ohms, 200 ohms, 500 ohms, or high impedance.

## MODEL 999 BALANCED LINE DYNAMIC

Same style and finish as Model 99. Equipped with Balanced Line features for critical applications and professional results under all conditions. Has voice coil and transformer leads insulated from ground and microphone case. Line is balanced to the ground. Response is flat within  $\pm 5$ db from 40-9000 cycles. Level: 52db below 1 volt/dyne/sq. cm. at high impedance. Complete with 20 ft. balanced line low capacity removable cable set with 3-pin polarized locking connection in a choice of standard impedances.

## MODEL U9S DYNAMIC

### Four Impedances at Your Fingertips

Whatever impedance you need—50 ohms, 200 ohms, 500 ohms or high impedance—you can get it quickly and easily with the turn of the switch on Turner U9S. This flexible unit handles toughest jobs. Same precision engineering and rugged construction as Model 999 with built-in multi-impedance transformer. Response is flat within  $\pm 5$ db from 40-9000 cycles. Level: 52db below 1 volt/dyne/sq. cm. at high impedance. Complete with 20 ft. removable cable set.

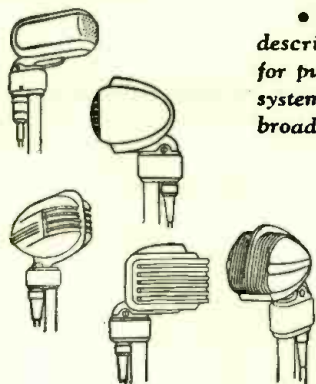

• Write for complete literature describing all Turner Microphones for public address, recording, call system, amateur and commercial broadcast, and special applications.

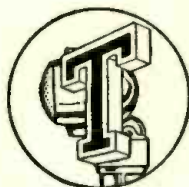

# Microphones BY TURNER

Licensed under U.S. patents of the American Telephone and Telegraph Company, and Western Electric Company, Incorporated.

**THE TURNER COMPANY**  
902 17th Street N. E. • Cedar Rapids, Iowa



# NOW SPRAYBERRY RADIO TRAINING

## GIVES YOU 8 BIG KITS OF RADIO EQUIPMENT

WITH A COMPLETE 6 TUBE SUPER-HETERODYNE RECEIVER

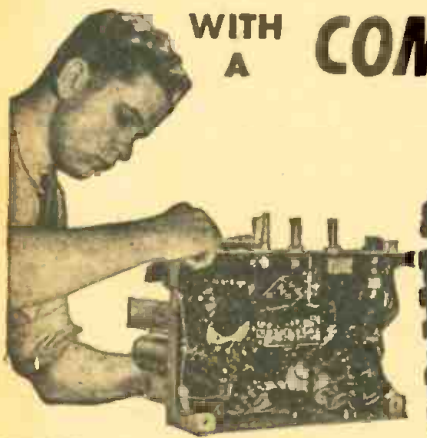

**YOU LEARN RADIO SERVICING**  
THROUGH INTENSIVE "SHOP-BENCH" PRACTICE



**YOU DO EXPERIMENTS, CONSTRUCTION, TROUBLE-SHOOTING**

I'll show you how to perform over 175 Instructive Experiments—how to build countless Radio Circuits. You'll learn a new, fast way to test Radio Sets without mfg. Equipment.



I give you a fine, moving-coil type Meter Instrument on Jewel Bearings—with parts for a complete Analyzer Circuit Continuity Tester. You learn how to check and correct Receiver defects with professional accuracy and speed.

You'll get valuable experience and practice building this Signal Generator and multi-purpose Tester. Makes a breeze out of fixing Radios and you don't have to spend money on outside, ready-made equipment.



Soldering, wiring, connecting Radio parts . . . building circuits with your own hands—you can't beat this method of learning. When you construct this Rectifier and Filter, Resistor and Condenser Tester, etc., you get a really practical slant on Radio that leads to a money-making future.

**HERE'S THE LATEST, SIMPLEST WAY TO TRAIN at HOME for a GOOD LIVING in RADIO-ELECTRONICS & TELEVISION**

I train your mind by putting you to work with your hands on a big 6-Tube Superheterodyne Receiver. And, believe me, when you get busy with real Radio Parts—8 big Kits of them—you really LEARN Radio and learn it RIGHT! You get the practical stuff you need to be useful in Radio, and that's what it takes to make money. You don't have to worry about what to do with these 8 Kits of

with real "Shop" practice, makes every subject plain and easy to understand and remember.

**A BUSINESS OF YOUR OWN . . . OR A GOOD RADIO JOB**

Soon after you begin Sprayberry Training, I'll send you my sensational BUSINESS BUILDERS. You'll find out how to get and do neighborhood Radio repair jobs for nice profits and rich experience while learning. This sort of work can easily pave the way for a Radio Service business of your own. But with Sprayberry Training, you're not limited. You can swing into any one of the swiftly expanding branches of Radio-Electronics INCLUDING Radio, Television, FM, Radar, Industrial Electronics. Be wise! Decide now to become a fully qualified RADIO-ELECTRONICIAN. Get full details about my Training at once! Mail coupon below for my 2 big FREE Books.

Parts. Step by step, I show you how to build circuits, test, experiment, trouble-shoot. And you don't need any previous experience. The Sprayberry Course starts right at the beginning of Radio! You can't get lost! Simplified lessons, coupled

**SEND FOR THESE FREE BOOKS**

"How to Read Radio Diagrams and Symbols"

Here's a valuable and wonderfully complete new book which explains in simple English how to read and understand any Radio Set Diagram. Includes translation of all Radio symbols. Send for this volume at once! It's free! Along with it, I will send you another Big Free book describing in detail my Radio-Electronic Training.



**MAIL COUPON TODAY!**

**SPRAYBERRY ACADEMY OF RADIO**

F. L. Sprayberry, President, Room 2017, Pueblo, Colorado

Please rush my FREE copies of "How to MAKE MONEY in RADIO, ELECTRONICS and TELEVISION," and "HOW to READ RADIO DIAGRAMS and SYMBOLS."

Name ..... Age .....

Address .....

City ..... State .....

(Mail in envelope or paste on penny postcard)



# JANUARY • 1947

## Special de Forest Issue

### 40th Anniversary of the Vacuum Tube

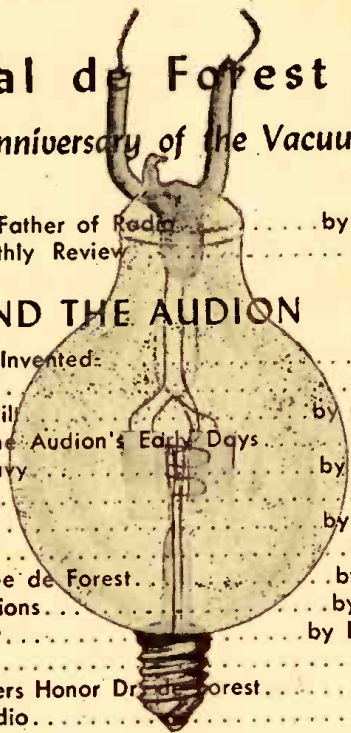

Editorial: de Forest — Father of Radio	by Hugo Gernsback	17
Radio-Electronics Monthly Review		114

## DE FOREST AND THE AUDION

How the Audion Was Invented	by Lee de Forest	19
Birth of the Audion	by Frank E. Butler	22
How Audions Were Built	by Gerald F. J. Tyne	27
Three Anecdotes of the Audion's Early Days		31
De Forest and the Navy	by George H. Clark	32
An Early Radiophone		36
First Radio Association	by Hugo Gernsback	37
First Phone Broadcast	by Frank E. Butler	38
Radio Inventions of Lee de Forest	by Fred Shunaman	41
E. I. Co. Sold First Audions	by Hugo Gernsback	45
De Forest the Inventor	by H. Winfield Secor	46
De Forest Patents		50
Motion Picture Engineers Honor Dr. de Forest		51
To the Father of Radio		52

## RADIO AND TELEVISION

Building a Telesiver	by Roy Freeland	60
Transmission with Light	by Richard H. Milburn	62
Replacing the Rectifier		64
The Cinematic Analyzer, Part II — Construction and Adjustment of the Analyzer	by E. Aisberg	65
Medium Power Transmitter	by R. L. Pormenter, W1JXF	67
The Scope — A Repair Tool	by S. Prenskey and J. Jacobsen	68
Simple Electronic Organ	by Harold Conroy	70
Antenna Principles, Part II — Multi-Element, Long-Line and Rhombic Antennas	by I. Queen, W2OUX	72
Television for Today, Part VIII — Video Amplifier Fidelity Considerations	by Milton S. Kiver	81
Multitester Plus V. T. V. M.	by J. Simrin	83
Radio Data Sheet 343 (Zenith Radio Models 8H032, 8H033, 8H050, 8H052, 8H061)		84
Trainee Five Radio	by Edwin Bohr	86
Cabinet Refinishing	by H. A. Nickerson	87
A Simple Metronome	by Dr. Angelo Montani	88
Test Holder for Crystal Grinding	by L. B. Robbins	88
Clip-On Radio Tester	by Homer L. Davidson	103

## DEPARTMENTS

Sound Engineering — No. 26	Conducted by A. C. Shaney	89
Transatlantic News	by Major Ralph Hallows	90
World-Wide Station List	Edited by Elmer R. Fuller	92
Technotes		105, 109
New Radio-Electronic Devices		106
Try This One		108
Radio-Electronic Circuits		110
The Question Box		112
Communications		140
Book Reviews		143

RADCRAFT PUBLICATIONS, INC. Hugo Gernsback, President, M. Harvey Gernsback, Vice President, G. Aliquo, Secretary.

Contents Copyright, 1947, by Radcraft Publications, Inc. Text and illustrations must not be reproduced without permission of Copyright owners. RADCRAFT PUBLICATIONS, INC. • PUBLICATION OFFICE 29 Worthington Street, Springfield 3, Mass. • EDITORIAL AND ADVERTISING OFFICES 25 West Broadway, New York 7, N. Y. Telephone REctor 2-9690.

BRANCH ADVERTISING OFFICES: Chicago: 308 W. Washington Street, Suite 1413, Chicago 6, Ill. Tel. Randolph 7363. Cleveland: Burdette Phillips, Manager, 405 Erie Bldg., Cleveland, Ohio. Tel. Main 9645. Detroit: Frank Holstein, Manager, 307-8 Boulevard Bldg., Detroit, Mich. Los Angeles: Ralph W. Harker, Manager, 606 South Hill St., Los Angeles 14, Calif. Tel. Tucker 1793. San Francisco: Ralph W. Harker, Manager, 582 Market St., San Francisco 4, Calif. Tel. Garfield 2481.

RADIO-CRAFT, January 1947, Volume XVIII, No. 4. Published Monthly on 28th of month preceding date of issue. Allow one month for change of address. When ordering a change, please furnish an address stencil impression from a recent wrapper. All communications about subscriptions should be addressed to the Circulation Manager, Radio-Craft, 25 West Broadway, New York 7, N. Y.

SUBSCRIPTION RATES: United States and possessions, Mexico, Central and South American countries, \$2.50 a year; \$4.00 for two years; \$6.00 for three years. Canada, 3.00 a year; \$5.00 for two years; \$7.50 for three years. All other foreign countries, \$3.25 a year; \$5.50 for two years; \$8.25 for three years. Special rates for members of the Armed Forces in U.S., or those addressed by A.P.O. or F.P.O. mail, \$2.00. Entered at Post Office, Springfield, Mass., as second-class matter under the Act of March 3, 1879.

FOREIGN AGENTS: Great Britain: Atlas Publishing and Distributing Co., Ltd., 18 Bride Lane, Fleet St., London E.C.4. Australia: McGill's Agency, 179 Elizabeth Street, Melbourne. France: Brentano's, 37 Avenue de l'Opera, Paris 2e. Holland: Technisch Bureau Van Baerle, Bemelmans & Co., Heemsteedsche, Dreef 124, Heemstede. Greece: International Book & News Agency, 17 Amarakis Street, Athens. S. Africa: Central News Agency, Ltd., 369 Smith Street, Durban, Natal. Universal Book Agency, 70 Harrison Street, Johannesburg. Middle East: Steimatzky Middle East Agency, Jaffa Road, Jerusalem. India: Magazines Distributors, 5 Bombay Mutual Annexe, Gunbow Street, Fort, Bombay 1.



Incorporating  
SHORT WAVE CRAFT TELEVISION NEWS  
RADIO & TELEVISION

### HUGO GERNSBACK

Editor-in-Chief

### FRED SHUNAMAN

Managing Editor

### M. HARVEY GERNSBACK

Consulting Editor

### ROBERT F. SCOTT, W2PWG

Technical Editor

### I. QUEEN, W2OUX

Editorial Associate

### ELMER FULLER

Shortwave Editor

### ANGIE PASCALE

Production Manager

### G. ALIQUO

Circulation Manager

### JOHN J. LAMSON

Advertising Director

### ALFRED STERN

Promotion Manager

### ON THE COVER:



Our cover this month shows Dr. de Forest and the radio tube which revolutionized a century.





Now IN YOUR OWN HOME *Learn*

# RADIO ELECTRONICS

*The Practical*  
"HOME-TESTED"  
*Modern "A-B-C" Way*



YOU USE ALL OF THESE RADIO PARTS  
TO BUILD  
AND OPERATE  
**7**  
DIFFERENT RADIO  
RECEIVING CIRCUITS

## NO PREVIOUS RADIO OR ELECTRICAL EXPERIENCE NECESSARY

DeForest's Training, Inc. provides every major home study aid to help you learn Radio-Electronics rapidly and thoroughly . . . to give you the experience and confidence needed for a responsible, Good-Pay Job, or to Start a Business of Your Own! Here is a REAL opportunity field for YOU . . . when you are a trained Radio-Electronics man! Just think of the tremendously exciting future ahead of FM Radio, Aviation and Broadcast Radio, Sound Motion Picture Equipment, Servicing and Sales of Radio Equipment, etc. Put yourself in this picture . . . See how you can benefit from a PRACTICAL training in this fascinating work! Think, too, of the coming possibilities ahead of Radar, Facsimile and Television. Send TODAY for the interesting, opportunity-revealing book, "Victory for You!" See how others probably no more talented or ambitious than you, have advanced in earning power after this training . . . how YOU can do it too! Mail the coupon NOW!

INCLUDING:

1. Simple Receiver
2. Two Tube Receiver
3. Tuned Radio-Frequency Receiver
4. Short Wave Receiver
5. Aviation Band Receiver
6. 4-Tube Superheterodyne
7. 5-Tube Superheterodyne with Magic Tuning Eye

PLUS SCORES OF OTHER FASCINATING, INSTRUCTIVE RADIO-ELECTRONIC EXPERIMENTS

WITH THE HELP OF

**A** EIGHT Big Kits of Actual "Learn-by-Doing" Radio Parts and Assemblies with which you make 133 fascinating SHOP METHOD EXPERIMENTS in your own home! Imagine building 7 different Radio Receivers that operate!

**B** A 16 mm Home Movie Projector and Twelve Reels of "Learn-by-Seeing" Home Movie Films . . . for picture-clear, fast understanding of Radio Fundamentals!

**C** Modern, well-illustrated, Loose-leaf Lessons, prepared in clear, simple, understandable language . . . to guide you throughout your training!

THEN GET THE HELP OF OUR EFFECTIVE EMPLOYMENT SERVICE

**VETERANS!**  
Big things are happening at DeForest's Training, Inc. for veterans! See how you can prepare yourself WITHOUT COST for a GOOD JOB or a BUSINESS OF YOUR OWN in the vast Radio-Electronic opportunity field.

16 MM MOVIE PROJECTOR  
YOU USE "LEARN-BY-SEEING" MOVIES



DEFOREST'S TRAINING, INC. INCLUDES INSTRUCTION IN MOTION PICTURE SOUND EQUIPMENT, FM RADIO AND TELEVISION . . . RESIDENTIAL TRAINING IN OUR MODERN CHICAGO LABORATORIES ALSO AVAILABLE—ASK US FOR INFORMATION!

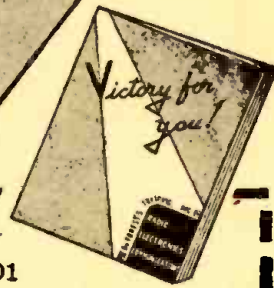

E. B. DEVRY, President  
DEFOREST'S TRAINING, INC.  
2535-41 North Ashland Ave., Dept. RC-D1  
Chicago 14, Illinois, U.S.A.

Send FREE "VICTORY FOR YOU!" BOOK, showing how I may make my start in Radio Electronics.

Name \_\_\_\_\_ Age \_\_\_\_\_  
Address \_\_\_\_\_ Apt. \_\_\_\_\_  
City \_\_\_\_\_ Zone \_\_\_\_\_ State \_\_\_\_\_  
 If under 16, check here for special information.  If a discharged Veteran of World War II, check here.

**DeFOREST'S TRAINING, INC.**  
CHICAGO 14, ILLINOIS

RADIO-CRAFT for JANUARY, 1947



# WHATEVER YOU NEED IN RADIO OR ELECTRONICS

PARTS...SETS...KITS  
TESTING EQUIPMENT...TOOLS  
PUBLIC ADDRESS EQUIPMENT  
TRANSMITTERS

## YOU CAN GET IT AT NEWARK!



### SERVICEMEN

Three big stores, each carrying tremendous stocks, are ready to serve you with tools, replacement parts, test equipment, sets or anything else you need. Wire, write or telephone if you can't visit one of our stores. If you can visit with us you'll find our trained staff of tremendous help to you.

### SERVICE

Mail orders are shipped the same day they are received. You don't have to wait when you buy from Newark. On special inquiries, we give you full information, prices and delivery dates promptly. Newark will give you service that will help you serve your customers better.



### PUBLIC ADDRESS SYSTEMS FOR EVERY NEED AND PURPOSE

No matter what your public address needs may be, Newark has the outfit that will do the job for you. All the well known, standard makes are carried in stock. Delivery is fast and dependable . . . in New York and Chicago we maintain our own delivery system . . . for out-of-town customers we ship orders the same day they are received.

All our stores are staffed by trained men who know public address needs and can help you select the outfit that will best serve your purpose. If your needs are unusual, they know how to make up special combinations to satisfy them efficiently.

If you can, visit one of our stores. If you can't come to see us, write, phone or telegraph and your inquiry will be answered promptly and fully. Newark has the stock, Newark has the 'know how', Newark can help you.

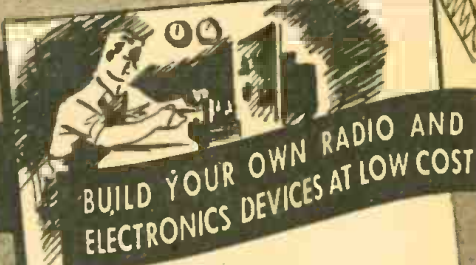

### BUILD YOUR OWN RADIO AND ELECTRONICS DEVICES AT LOW COST

With Newark's kits and parts you can easily build radio receivers, transmitters, amplifiers, and other exciting radio and electronics devices.

Make a good radio receiver for yourself or a fine record player with automatic changer at tremendous savings. You can construct these and many other radio and electronics devices easily. Our men know how to make them and will gladly show you if you can visit one of our stores—or will explain clearly by mail.

### FOR GOOD BUYS AND A GOOD TIME VISIT OUR BIG BARGAIN COUNTERS

These big bargain counters in all our stores, are loaded down with special items available in quantities too small to advertise. Marvelous war-time sets, new small gadgets you can have fun with . . . all sorts of new parts and special things you'll want to see. Come in, look around and ask all the questions you wish. Come in often you'll have a wonderful time.

### WRITE FOR OUR BIG BARGAIN BULLETIN LISTING THE LATEST AVAILABLE EQUIPMENT

Magazines are printed months before you read them, stocks change, new things are developed and made, so we give you the very latest news about the very newest things in radio and electronics in our Big Bargain Bulletin. Send for your copy today and know all about the latest equipment first. When writing address Dept. F-3



N.Y.C. Stores: 115 W. 45th St. & 212 Fulton St. Offices & Warehouse: 242 W. 55th St. N.Y. 19



Grasp the **NEW OPPORTUNITIES** in

# RADIO

## ELECTRONICS AND TELEVISION NOW!



Modern Radio — FM Broadcast and Reception — Television — Industrial Electronics; Power, Control, Communications — new equipment and methods demand new technical ability and experience. Keep up to date with the latest.

**MODERN RADIO EQUIPMENT FOR YOU TO USE AND KEEP**

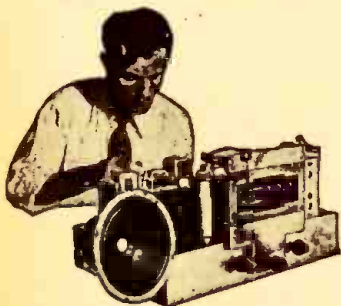

The very essence of National Shop Method Home Training is **EXPERIENCE**. You get actual experience by working with modern Radio and Electronic equipment—building many types of circuits. You may build a fine, long distance **MODERN SUPERHETERODYNE**, signal generator, miniature radio transmitter, audio oscillator, etc.—many other standard actual operating pieces of equipment—conduct cathode ray and other experiments. This practical work advances with your training—**YOU LEARN BY DOING!**

## Shop Method Home Training

By a Real Established Resident School with its own FM Studios, Shops and Laboratories.

### TRAIN WITH ADVANCED TECHNIQUE

The good jobs in Radio Electronics now go to the men who are equipped to handle them. It takes training and experience. National Schools, one of the oldest and largest trade schools in the country, makes it possible for you to get this training right in your own home **IN YOUR SPARE TIME**.

National maintains modern resident training Studios, Shops and Laboratories where instructors and engineers are working constantly to improve training methods. **SHOP METHOD HOME TRAINING** is a logical extension of this practical system.

A **FREE** lesson that shows you how practical and systematic this new training method is will be sent you without obligation. You may keep and use this lesson to prove to yourself just how practical National Training really is.

Get one of the many **NEW JOBS** that demand new techniques and methods in Modern Radio. Get your share of the **NEW BUSINESS** that servicing the new sets and equipment demands. Experts agree that Radio, Television and Electronics present opportunities

much greater than ever before! Radio is expanding with far-reaching improvements in reception. No one knows yet how great the Television market will be. Electronics will touch almost every walk of life—in industry and in the home.

**TURN YOUR INTEREST IN RADIO INTO A CAREER THAT WILL ASSURE YOU SUCCESS AND SECURITY.**

### FIND OUT WHAT NATIONAL TRAINING CAN DO FOR YOU

Where do you stand today in modern industrial progress? What does the future hold for you? You owe it to yourself to investigate this opportunity. With National Training **YOU GET AHEAD FAST**—you may step into a good position or start a business of your own, with little capital, even before you complete your National Course.

Fit yourself for a career of independence, good earnings, success and security in one of the fastest growing fields in industry. For full information, just send your name and address on the coupon and mail it **TODAY**.

# FREE LESSON



APPROVED FOR TRAINING UNDER GI BILL



## Get This Book FREE

This big book presents the facts about the field of Electronics and your opportunities in it together with full information about the advanced National Training. Read it and make up your own mind that National Training will equip you for a great future. No salesman will call on you from National. The book is **FREE** with your sample lesson. **Clip and mail the coupon TODAY!**

## See What National Training Has Done For These Men

National Shop Method Home Training wins good jobs, independence and security. Take the word of National men who have established records in their favorite Radio, Television, or other branches of Electronics.



Clifford Hannah, Portage La Prairie, Manitoba, Canada, writes: "My training has brought results as I'm in line for

another raise thanks to National's encouragement and thorough training."



From O. K. Ivey, Washington, D. C., comes this endorsement: "I believe National offers the best course to be had ... Keep up the good work."

Joseph Michel, Jr., Granite City, Illinois, writes: "I am enthused with National training. I am now earning \$225

a month as a radio operator and technician and \$20 a week more in my shop at home."



Here's a statement from R. R. Wright, Blackfoot, Idaho: "Due to my training at National I was selected to instruct in the laboratory work of Navy and Marines."

Read what other enthusiastic students have written about National Training in the big 40 page book we will send you.

## NATIONAL SCHOOLS

LOS ANGELES 37, CALIFORNIA EST. 1905



### MAIL OPPORTUNITY COUPON FOR QUICK ACTION

National Schools, Dept. 1-RC  
4000 South Figueroa Street, Los Angeles 37, California

(Mail in envelope or paste on penny post card)

Mail me **FREE** the two books mentioned in your ad including a sample lesson of your course. I understand no salesman will call on me.

NAME ..... AGE .....

ADDRESS .....

CITY ..... STATE .....

Include your zone number

Check here if veteran of World War II



# A Handy Guide

TO

# SPRAGUE EL SELF-MOUNTING MIDGET CAPACITORS (Can Type)



## Easier to install... Tops for Dependability

Time is money in radio servicing. Save it—make more of it—by using Sprague type EL can type dry electrolytic capacitors for every possible replacement use. They're small enough to fit anywhere. They're absolute tops in dependability. And you can mount them in a jiffy, either by direct chassis mounting or by means of their convenient twist prongs. Both bakelite and metal washers are supplied with each unit.

Ask for Sprague Type EL Capacitors by name!

# SPRAGUE

PRODUCTS CO., NORTH ADAMS, MASS.

### SINGLE SECTION

Catalog No.	Mfd.	Voltage DC working	Dimensions	
			D	L
EL-11	2000	10	1 1/4	3
EL-111	1000	15	1 1/4	3
EL-121	2000	15	1 1/4	3
EL-142	40	25	1 1/4	2
EL-112	100	25	1 1/4	2
EL-152	500	25	1 1/4	2 1/4
EL-122	1000	25	1 1/4	2
EL-50	150	50	1 1/4	2 1/4
EL-55	500	50	1 1/4	2 1/4
EL-31	30	150	1 1/4	2 1/4
EL-51	50	150	1 1/4	2 1/4
EL-14	40	200	1 1/4	2
EL-12	20	250	1 1/4	2
EL-30	30	250	1 1/4	2 1/4
EL-42	40	250	1 1/4	2
EL-6	60	250	1 1/4	2 1/4
EL-203	15	300	1 1/4	2
EL-33	30	300	1 1/4	2
EL-53	50	300	1 1/4	2 1/4
EL-123	125	300	1 1/4	2
EL-5	50	350	1 1/4	2
EL-125	125	350	1 1/4	2
EL-10	10	400	1 1/4	2
EL-20	20	400	1 1/4	2 1/4
EL-80	80	400	1 1/4	2 1/4
EL-1	10	450	1 1/4	2
EL-15	15	450	1 1/4	2
EL-2	20	450	1 1/4	2 1/4
EL-3	30	450	1 1/4	2
EL-4	40	450	1 1/4	3
EL-115	10	525	1 1/4	2

### DUAL SECTION

EL-242	40-40	25	1 1/4	2
EL-250	50-50	50	1 1/4	2
EL-221	20-20	150	1 1/4	2
EL-231	30-15	150	1 1/4	2
EL-230	30-30	150	1 1/4	2
EL-24	40-20	150	1 1/4	2
EL-15	50-30	150	1 1/4	2
EL-25	50-50	150	1 1/4	2
EL-26	60-60	150	1 1/4	2
EL-101	10-10	250	1 1/4	2
EL-120	20-20	250	1 1/4	2
EL-245	40-40	250	1 1/4	2
EL-21	10-10	300	1 1/4	2
EL-253	15-15	300	1 1/4	2
EL-22	20-20	300-25	1 1/4	2
EL-23	30-30	300-350	1 1/4	2
EL-32	30-20	350	1 1/4	2
EL-254	15-15	400	1 1/4	2 1/4
EL-234	80-10	400	1 1/4	2
EL-210	10-10	450	1 1/4	2
EL-151	15-10	450	1 1/4	2 1/4
EL-220	20-20	450	1 1/4	2
EL-240	40-40	450	1 1/4	2

### TRIPLE SECTION

EL-325	20-20-20	25	1 1/4	2
EL-335	30-30-30	50	1 1/4	2
EL-313	10-30-30	150	1 1/4	2
EL-320	20-20-20	150	1 1/4	2
EL-224	40-20-20	150	1 1/4	2
EL-340	40-40-40	150	1 1/4	2
EL-321	30-20-100	150-150-6	1 1/4	2
EL-222	20-20-20	150-150-25	1 1/4	2
EL-324	30-20-20	150-150-25	1 1/4	2
EL-332	30-30-20	150-150-25	1 1/4	2
EL-43	30-40-25	150-150-25	1 1/4	2
EL-343	40-30-20	150-150-25	1 1/4	2
EL-351	50-30-100	150-150-25	1 1/4	2
EL-352	50-50-20	150-150-25	1 1/4	2 1/4
EL-355	10-15-15	250	1 1/4	2
EL-315	10-15-30	250	1 1/4	2
EL-354	40-20-20	250	1 1/4	2
EL-331	15-15-20	250-250-25	1 1/4	2 1/4
EL-334	30-30-70	250-250-25	1 1/4	2
EL-314	10-20-30	250-250-350	1 1/4	2
EL-316	10-10-10	300	1 1/4	2
EL-333	20-20-20	300-300-25	1 1/4	2
EL-341	40-15-20	300-300-25	1 1/4	2 1/4
EL-102	10-10-20	350-350-25	1 1/4	2
EL-153	15-10-20	350-350-25	1 1/4	2
EL-326	15-15-20	350-350-25	1 1/4	2 1/4
EL-212	20-10-20	350-350-25	1 1/4	2 1/4
EL-323	30-20-20	350-350-25	1 1/4	2
EL-311	10-10-10	400	1 1/4	2 1/4
EL-342	15-15-40	400-400-25	1 1/4	2
EL-322	20-20-20	400-400-25	1 1/4	2
EL-310	10-10-10	450	1 1/4	2 1/4
EL-344	15-15-10	450	1 1/4	2
EL-362	20-15-10	450-300-300	1 1/4	2
EL-363	10-10-20	450-350-25	1 1/4	2
EL-364	15-20-20	450-350-250	1 1/4	2
EL-345	10-10-10	450-450-25	1 1/4	2
EL-202	10-10-20	450-450-25	1 1/4	2
EL-312	10-20-20	450-450-25	1 1/4	2
EL-353	15-15-20	450-450-25	1 1/4	2
EL-205	20-15-20	450-450-25	1 1/4	2
EL-350	20-20-20	450-450-25	1 1/4	2
EL-330	30-30-20	450-450-25	1 1/4	2 1/4
EL-360	15-15-10	450-450-300	1 1/4	2
EL-215	15-5-15	450-450-350	1 1/4	2

### QUADRUPLE SECTION

EL-434	30-30-30-40	150-150-150-25	1 1/4	2
EL-443	40-40-30-20	150-150-150-25	1 1/4	2
EL-452	50-50-50-20	150-150-150-25	1 1/4	2
EL-422	40-20-10-20	200-300-200-25	1 1/4	2
EL-412	10-10-10-20	300-300-300-25	1 1/4	2
EL-432	40-40-20-20	350-300-300-25	1 1/4	2
EL-415	20-10-5-10	350-350-350-25	1 1/4	2
EL-442	20-20-20-20	400-400-400-25	1 1/4	2 1/4
EL-410	10-10-10-10	450	1 1/4	2
EL-420	20-20-20-20	450	1 1/4	2
EL-421	20-15-15-20	450-350-350-25	1 1/4	2
EL-423	20-15-20-20	450-450-25-25	1 1/4	2
EL-425	20-20-30-30	450-450-300-300	1 1/4	2
EL-431	10-10-10-20	450-450-450-25	1 1/4	2
EL-424	40-30-10-20	450-450-450-25	1 1/4	2

JOBGING DISTRIBUTING ORGANIZATION FOR PRODUCTS OF THE SPRAGUE ELECTRIC COMPANY

RADIO-CRAFT for JANUARY, 1947



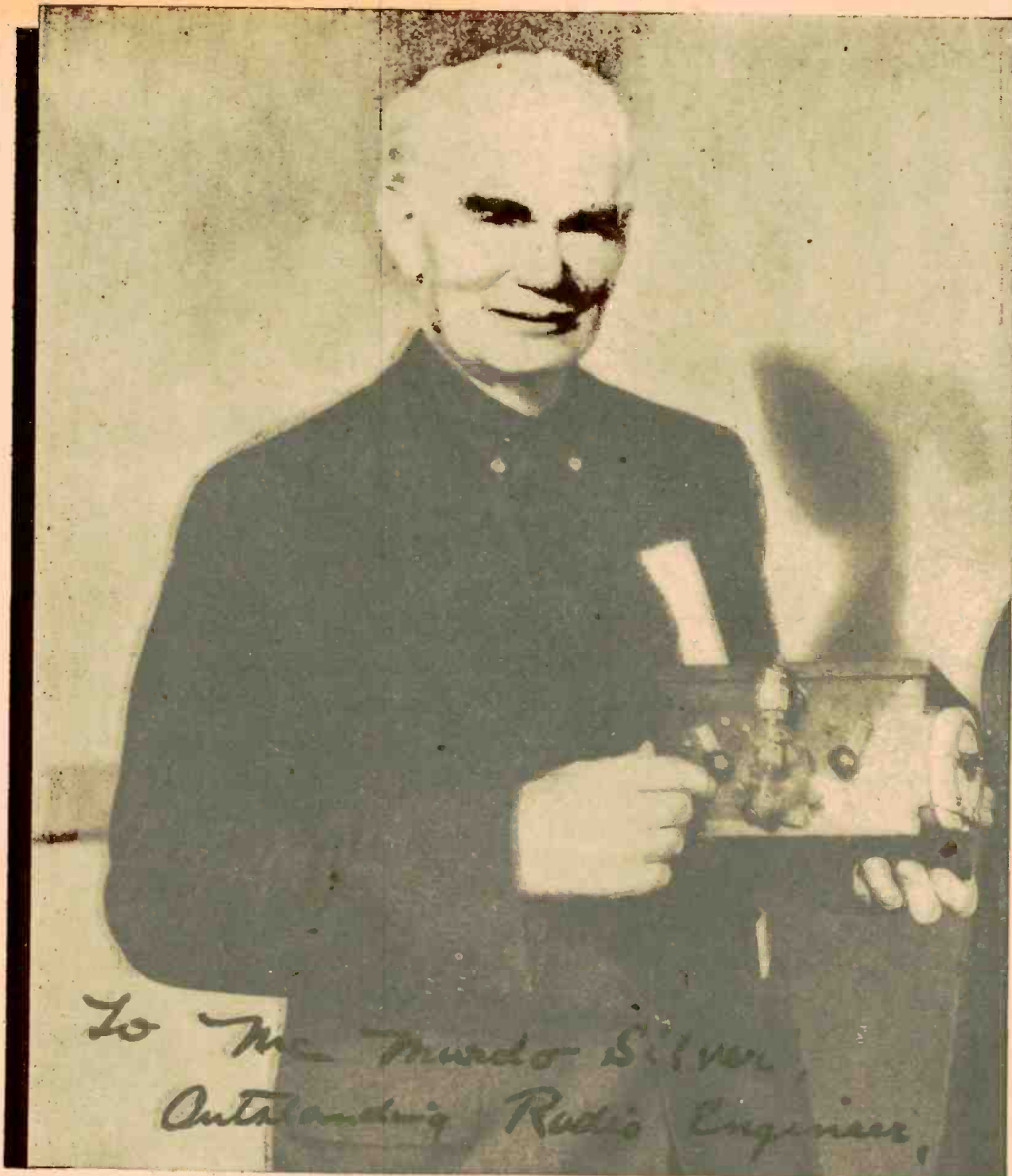

*To Mr. Murdo Silver,  
Outstanding Radio Engineer,*

*With regards and best wishes  
'37.  
Lee de Forest.*

**AND WE SALUTE YOU, DR. deFOREST,  
THE REAL FATHER OF MODERN RADIO..**

Send postcard for catalog of  
new measuring and communica-  
tion equipment, kits, parts.

OVER 35 YEARS OF RADIO ENGINEERING ACHIEVEMENT

*McMurdo Silver Co., Inc.*

1249 MAIN STREET • HARTFORD 3 • CONNECTICUT

RADIO-CRAFT for JANUARY, 1947

## THE AMERICAN TELEVISION LABORATORIES INC.

### *Takes Pride in Announcing*

#### **The Construction and Installation of the de Forest Radio and Television Laboratory in our new North Television Center Bldg. at 5050 Broadway, Chicago**

Here, Dr. de Forest will devote his entire time to development and research on behalf of the radio and television industry.

The five thousand student veterans, now enrolled in our Television School, are inspired and encouraged by his presence. The new student groups that enter each week look forward to the time when they, too, will become proficient members of the great and still growing electronic industry that Dr. de Forest created with his invention of the vacuum tube.

Dr. de Forest, at the age of 73, continues to pioneer. His present work is destined to bring him new honors and add to his already overwhelming achievements.

Thus, we salute Dr. de Forest, not only as a distinguished scientist and inventor but also as a man who has personally demonstrated the opportunity of reward for scientific enterprise offered by our American way of life.

U. A. SANABRIA, *President*  
AMERICAN TELEVISION LABORATORIES, INC.

VETERAN TRAINING DIVISION  
AND RESEARCH LABORATORY

5050 Broadway

Chicago 40

MANUFACTURING DIVISION  
AND EXECUTIVE OFFICES

525 Plymouth Court

Chicago 5



# DE FOREST—FATHER OF RADIO

By Hugo Gernsback

**T**HE year 1947 marks the 40th anniversary of the radio vacuum tube—Dr. Lee de Forest's three-element audion, the first grid radio tube. While de Forest invented other audions before 1907, these did not contain the all-important and vital grid. His application for patent of this tube is dated January 29, 1907, hence we can safely say that this date marks the birth of modern radio.

And what a milestone it proved to be in the history of radio! Imagine for a moment that the audion had not been invented: We would have no electronics, no radios, no broadcasting, no ocean phone, no talking motion pictures, no amplifiers, no television, no klystrons, no cyclotrons that made possible fission and atomic energy and its bombs, no guided radio weapons—and hundreds of other radio wonders, plus myriads of new ones to come.

It will always remain a vivid fact which we must never forget: de Forest gave us these priceless gifts—gifts that changed our lives, our habits, that annihilated distances, that made the spoken word and music through all space on this planet a reality, which in time will unite humanity as nothing has ever done before.

Verily—to paraphrase Winston Churchill: "NEVER IN THE HISTORY OF THE WORLD HAS SO MUCH BEEN OWED, BY SO MANY, TO ONE MAN."

The callous always will parrot the hackneyed cliché: "If he hadn't invented the vacuum tube, somebody else would have." Maybe so—but it was de Forest who did it first—and how, under what heartbreaking obstacles and disappointments!

De Forest never was a "lucky" inventor who just stumbled accidentally upon an epoch-making invention—as for instance Dr. Roentgen's discovery of the X-ray. No, he literally "sweated it out."

This, too, was seemingly preordained. Born into the parsonage of a poor Iowa minister he was literally steeped in such virtues as reverence, discipline, humility and thrift. All this was augmented by the fact that his mother, too, was the daughter of a minister.

Reared under the lash of severe discipline, poverty, and denial in the parsonage, the young boy developed a searing hunger for the better things of life. His constant dream was to better his condition. Fortunately, he was gifted not only with a never-to-be-satisfied curiosity, but with an imagination of heroic dimensions.

Thus we later find young Lee, against the wishes of his family, who wanted him to go to a theological seminary, enrolled at Yale University.

After the first semester one of the professors gave a lecture which was to change the entire course of de Forest's life. The lecture was on the electromagnetic wave theory with a demonstration of Heinrich Hertz's experiments. This caused a veritable flare-up in the young student who made this entry in his notebook:

"I shall learn all about the atom . . . shall guess its shape . . . shall postulate its causes and attractions . . . and I SHALL INVENT THE REASON FOR IT."

A bombastic promise—but it was more than fulfilled. It has been my great pleasure to have known Lee de Forest since 1906—over forty years. I have come to know him very well, and I have had many opportunities to study him at close quarters over the years. I have

been fortunate to have known Edison, Tesla, and other inventors equally well, and therefore believe myself qualified to judge the outstanding qualities of such men.

One cannot be long in de Forest's company before realizing that among his greatest characteristics is his inherent modesty. He speaks in measured, quiet phrases. His unusually deep-set eyes proclaim the man of science, the indefatigable worker, the type of man who never gives up a quest in search of light and truth. His complete disregard of his attire, his frugal living, his constantly preoccupied air, points to his tireless toil and zest for new worlds to conquer. Indeed at 73, he has as yet not found time to begin his autobiography.

Like so many men of the genius type, de Forest has an utter disregard for money. Finances have never meant a thing to him, except as a means to new scientific conquests, for research and for his inventions. Financial transactions bore him to distraction—and unfortunately for him the world has seen fit to take advantage of this: a pittance for his vacuum tube, his regeneration invention, his radiophone (broadcasting), as well as dozens of his more than two hundred inventions.

Few of history's great inventors have been paid so niggardly for epoch-making patents. Harassed by patent suits against him and countersuits which he had to bring in turn against others, the little money that was given him soon vanished. Once, because he was so rash as to tell a Federal court that with his radiophone a man would soon be able to talk across the ocean, the Father of Radio almost went to jail! If not for the pleas of a good attorney, de Forest would have been imprisoned for his temerity in predicting modern broadcasting!

Nothing ever came easy to the great inventor. The invention of the audion was no exception. It was an epic in frustration, in dogged plodding against seemingly insuperable, mountainous difficulties. There are too many witnesses who worked with him and who certified how he started with his Welsbach gas flame audion and step by step, through literally thousands of separate experiments, finally battled himself to the three-element grid audion. In spite of all this evidence, there are even today jealous, narrow-minded intolerants who say:

"Oh, de Forest, he just stuck a grid into the Fleming valve!" This is like saying: "The Wright brothers, because they stuck a propeller on an old kite."

Do all these soul-trying tribulations discourage Lee de Forest? Not in the least. His mind is as clear as ever at 73, his ideas as young as of yore, his curiosity keener than ever. The other day he and I discussed certain new aspects of a technical problem in television. For the first time during a two-hour conversation his deep-sunk eyes flashed and sparkled! His alert mind was stalking an idea once more!

This augurs well for his future. Let all of us—the entire radio-electronic fraternity—congratulate Dr. Lee de Forest on the 40th anniversary of his famed audion. Then let us wish him continuous good health, a long life, and many new laurels.

And, may I add, let the radio industry reward him financially for the staggering debt it owes the Father of Radio, which it can never hope to fully repay him.



# HOW THE

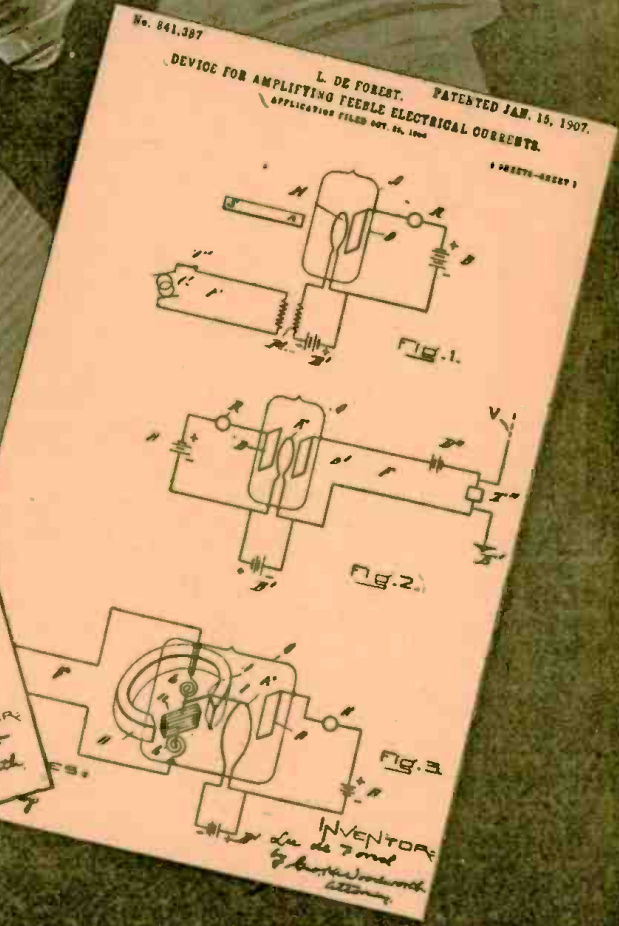
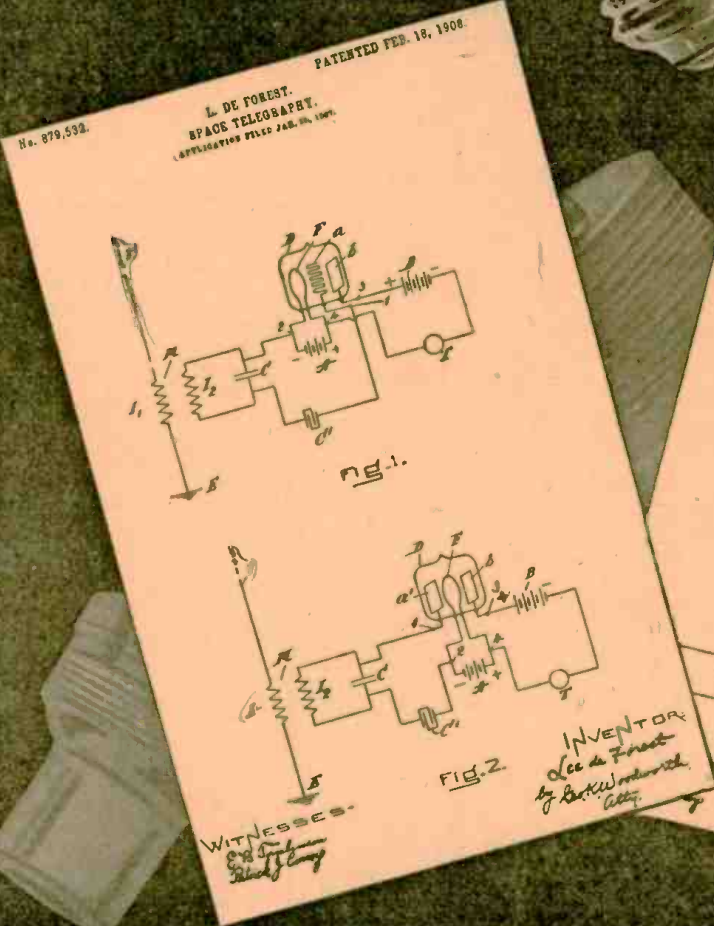



# AUDION WAS INVENTED

Lee de Forest



IN THE summer of 1900, I was working under the light of a Welsbach gas burner in my hall bedroom in Chicago, experimenting with my so-called "Sponder," an anti-coherer for the reception of electrical waves for use in wireless telegraphy. One night I noticed that whenever the little spark from my transmitter coil was put in operation the light from the Welsbach burner dimmed. When my transmitter key was lifted, the normal light of the burner was restored. Thus I was able to translate into light variations the signals from my key. I was amazed and highly elated by this unexpected phenomenon, and for several weeks played with it, believing that I had accidentally discovered that incandescent gases were affected by Hertzian waves, and that here I had discovered an absolutely new principle which might be of the utmost value as a detector for wireless telegraphy. This illusion persisted until my assistant and I put the spark coil in a closet and closed the wooden door; thereupon the fluctuations of the gas burner were no longer observed. This proved conclusively that the effect observed was not due to the electrical waves from the spark, but to the sound waves therefrom. I had merely hit upon a new type of sensitive flame.

I was intensely disappointed by this outcome, but I was positive that there must be, nevertheless, some change in the conductivity of incandescent gases resulting from the passage therethrough of high-frequency electrical waves, and I determined to investigate further and prove that my original conception had a basis in the physics of gases.

## Early Flame Detectors

It was not until 1903, when I was working in a small laboratory at 11 Thames Street, in lower Manhattan, that I had leisure and opportunity to resume my work in this direction. There I used a Bunsen burner, locating within the flame two platinum electrodes, one of which was connected through the telephone receiver to a dry battery, and thence to the other platinum electrode. I enriched the flame with sodium, or common salt.

I then found that when the electrodes were properly located in the gas flame the signals from my spark transmitter were *distinctly audible* in the telephone receiver. I made countless experiments with this phenomenon; and to prove definitely that the effect was not acoustic but electrical, I connected one of the flame electrodes to my antenna, the other to the ground, and actually obtained wireless signals from ships in New York harbor.

Realizing that a gas-flame detector would be wholly unsuited for practical wireless work, I thought of other means for heating the gases. I tried a small electric arc—which was altogether too noisy to be of any use. After several futile attempts to build such a device myself, I persuaded Mr. McCandless, a manufacturer of miniature incandescent lamps, to build for me a tube containing a platinum plate and carbon filament. The plate was connected to the positive side of the dry battery; the negative terminal to the filament. In series was a telephone receiver. This device was *not* the Fleming valve. It has always been quite impossible for me to understand the confused idea, in the minds of some otherwise keen thinkers, that the audion differed from the Fleming valve merely by the insertion of a third electrode therein. *Without the use of the B-battery the valve would be nothing but a rectifier with one too many electrodes.* The employment of the local battery in the plate circuit is just as necessary an element to the success of the device as is the grid itself. At the time I was working on the two-element audion with B-battery, I had never heard of the Fleming valve. My approach to this perfected device was by an entirely different series of events, and began with the gas-flame detector.

## Vacuum-Tube Detectors

This device was a genuine *relay*, in which the local energy of the plate battery supplying the current through the remaining gas in the tube was controlled by pulsations of the incoming high-frequency waves, which were picked up on an antenna connected to the plate electrode, the filament being connected to the ground. This was the same arrangement I had previously used with the gas flame detector. At that time I had requested McCandless not to exhaust the tube to any high degree of vacuum, because I then thought that the presence of gas was an essential element. This diode detector, as stated above, was intrinsically very much more than a simple rectifier of high-frequency current. The addition of the plate battery made a very great difference in the intensity of the signals received, for I was employing the high-frequency energy, not to actuate my telephone diaphragm, as Fleming had done, but to control very much larger quantities of energy from the local battery.

I argued that the above arrangement was imperfect because it permitted part of the high-frequency energy to pass to earth through the telephone and B-battery circuit, instead of concentrating it upon the ions between the plate and filament. To avoid this difficulty and still improve the sensitivity of the



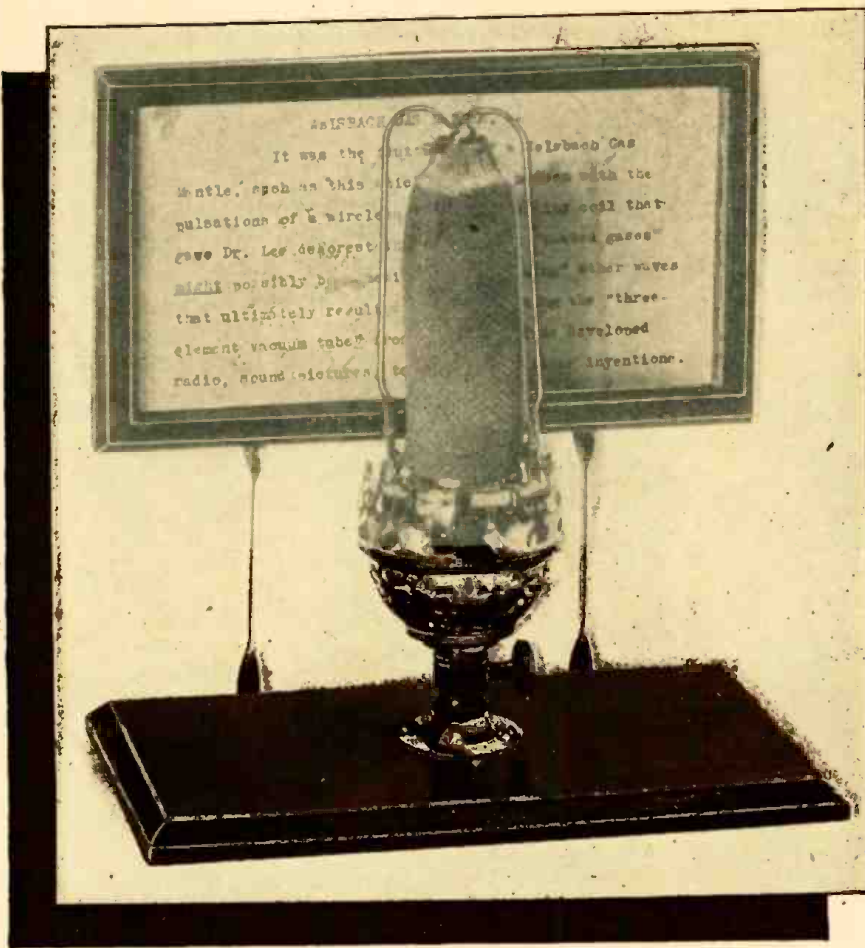

Welsbach gas mantle, starting point of the series of experiments which led to the audion.

detector, I wrapped a piece of tin foil around the outside of the cylindrical-shaped gas envelope, and connected this third electrode to the antenna or to one terminal of the high-frequency device. I then realized that the efficiency could be still further enhanced if this third electrode were introduced within the envelope. I induced McCandless to construct another "audion," as I then called it. This last device contained two plates with a filament located between them, and, as before, a considerable amount of gas in the envelope. This detector showed further distinct improvement over its predecessors.

### The Grid Audion

It occurred to me that the third, or control, electrode should be located more efficiently, between plate and the filament. Obviously, this third electrode so located should not be a solid plate. Consequently I supplied McCandless with a small plate of platinum, perforated by a great number of small holes. This arrangement performed much better than anything preceding it, but in order to simplify and cheapen the construction I decided that the interposed third electrode would be better in the form of a grid, a simple piece of wire bent back and forth, located as close to the filament as possible.

At this time I was using a 6-volt filament energized from a dry or storage battery, which I called the A-battery; the plate battery I called the B-battery—terminology which has persisted to this day.

As the various experiments and improvements

outlined took place during the period 1903 to 1906 and later, I applied for successive patents. At that time the Patent Office was not glutted as it is today, and my applications were related to an entirely new art, so that the Office issued my patents within only a few weeks or few months after filing.

Early in 1907 I conceived the idea that this remarkable wireless telegraph detector, the three-element, or grid, audion—which had already covered itself with glory in the minds of the hams and wireless telegraph operators—might also be useful as an amplifier of audio-frequency or telephonic currents. I had made some experiments in this direction, and took out a patent containing very broad claims on the device as an amplifier of currents without limitation of the frequency thereof. This patent, No. 841,387, granted January 15, 1907, has since been acclaimed as one of the most valuable patents ever issued by the United States Patent Office. The same, of course can be truthfully said about the patent on the grid electrode, No. 879,532, filed January 29, 1907.

In the summer of 1906 I presented a paper before the American Institute of Electrical Engineers describing the audion, but only as a diode *using the B-battery*. I had not then applied for a patent on the grid, or control-electrode, type, and therefore I made only veiled reference in this paper to it. The grid patent was filed on January 29, 1907.

### Early Types of Audions

The first audions were of cylindrical form; later, in 1907 or 1908, McCandless suggested that it would be easier for him to construct the device in the spherical form. In the first audion the grid and plate electrodes were both brought out near the base; but in 1907 the plate and grid electrodes were brought out through the top of the tube. To distinguish readily between the two, I used a red sleeving over the lead to the plate, and a green sleeving over the grid wire—"green for grid," to be easily remembered by the operator.

In my first experiments on the audion as an amplifier for telephonic currents I added a third, or C-battery as I called it, in series with the control electrode. Although, unfortunately, I did not specify the polarity of this C-battery, the circuit diagram of the amplifier patent shows it with its *negative* terminal connected to the control electrode. This was the way I always employed it; but due to this unfortunate omission from my specification, Fritz Lowenstein was able, a few years later, to obtain a very valuable patent covering the negative bias of



the grid. He was, however, by no means the first to apply this negative bias to the control electrode.

### Later Audion Improvements

From 1906 to 1910 I made countless improvements or changes in the form of the audion, such as the substitution of tantalum and then tungsten for the carbon filament; the use of nickel for plate and grid instead of platinum; the double filament so arranged that if one burned out the second one could be readily connected, thus doubling the life of the detector. As early as 1907 McCandless began to pump my tubes to the same vacuum he employed in his miniature incandescent lamps. Naturally some of the tubes contained more gas than did others, and we found that a very small amount of gas made the device a more sensitive detector than those of higher vacuum. When used as a detector of wireless signals, the lack-of-linearity characteristic was of course of no importance—maximum sensitivity was what we all were after. But so long as only an “incandescent lamp vacuum” was employed, it was impossible to use more than 22 or 30 volts in the B-battery without producing the “blue arc” which at once rendered the device extremely insensitive.

My patents show types of audions employing two, three, or more grids, as well as the “double audion” having one plate and grid on either side of the double filament. The latter arrangement developed into a beautiful oscillator, the first push-pull type in electronic history.

It was not until the summer of 1912 that I actually succeeded in developing the audion and its accompanying circuits into a genuine amplifier of telephonic currents. Seeking to make this amplifier more efficient and able to handle larger power, I besought McCandless to exhaust the tubes to the highest possible degree, to permit the use of more plate voltage. But the best that he could do still restricted this voltage to about 45. Thereupon I took some of his tubes to a manufacturer of X-ray tubes in San Francisco, who re-exhausted these to the best of his ability, using mercury vapor diffusion pumps. (McCandless had used only mechanical pumps.) With these re-exhausted tubes I was able to use as high as a 220-volt plate battery, without causing the “blue arc.” Three of these high-vacuum audions

connected in cascade gave amazing audio-amplifier effects, so that using as my input source a telegraph wire on which music or speech had been recorded, and as my output device a loudspeaker of the 1912 vintage, I was able to hear the reproduction of voice and music over a distance of 100 feet or more in the open air. Thus it is evident that the approach to the radio, or amplifier, tube possessing an extremely high vacuum was merely a gradual, and perfectly obvious, result of the growing requirement for more power from the amplifier or the oscillator. More power demanded higher voltages, and it was obvious that higher voltages would necessitate higher degrees of vacuum. I never considered for a moment that there was any invention involved in the gradual evolution of the audion from a gaseous, or low-vacuum, to a high-vacuum device.

At this point in the development of the audion amplifier I was requested by my good friend John Stone to bring my demonstration apparatus from Palo Alto, California, to show to the engineers of the telephone company in the Western Electric laboratory in New York. From that point on, the further development and refinement of the audion amplifier to its present degree of ultra-perfection is well-known electronic history, and requires no résumé here.

### Regeneration and Oscillation

During those epoch-marking experiments in Palo Alto, in the summer of 1912, I accidentally hit upon the feed-back circuit, which made of the audion amplifier an oscillator of currents of any frequency. Thereafter began the intensive development of the “oscillation,” as I then called it, in larger and larger sizes and degrees of power, until in 1915 I was employing a 25-watt power tube for broadcasting from my Highbridge, Bronx, laboratory steel tower. Simultaneously, the Western Electric engineers were developing the oscillator along very similar lines to a point where they were able, utilizing a battery of one hundred or more of these tubes, to transmit the human voice across the Atlantic without wires—a feat the prediction of which by myself, just two years previously, had been considered a ridiculous improbability, had almost resulted in my incarceration in Atlanta Penitentiary!

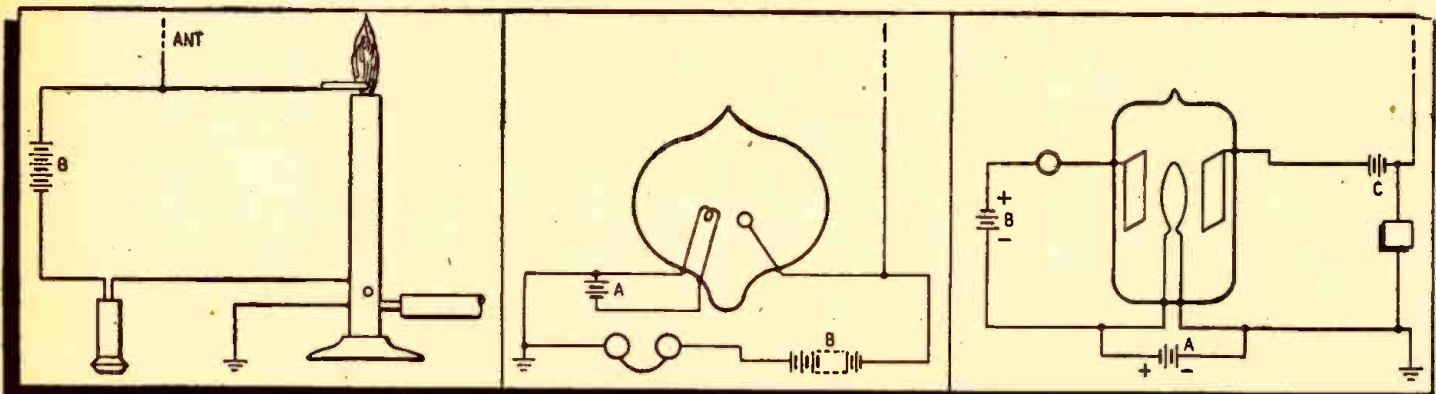

Evolution of the audion. Even the earliest flame detectors incorporated the B battery, as shown in the left-hand figure (Patent No. 867,878). The circuit at center (Patent No. 836,070) is essentially the same, with a heated filament in a low-vacuum tube taking the place of the Bunsen burner flame. Thus the B battery was also a feature of the earliest two-element audions. In the circuit at right (Patent No. 841,387) we see the separation of r.f. and local circuits, as well as the C battery (credit for the invention of which was lost to de Forest because polarity markings were omitted from the patent drawing). Obviously the whole series of heat detectors were thermionic relays, not simple rectifiers.



# BIRTH OF THE AUDION

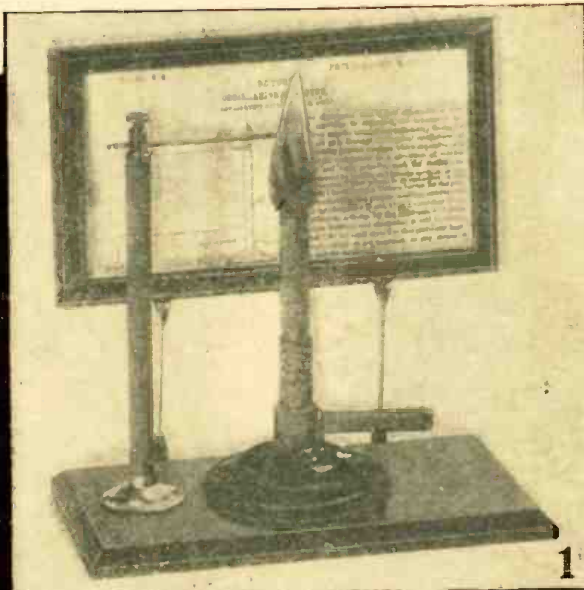

1

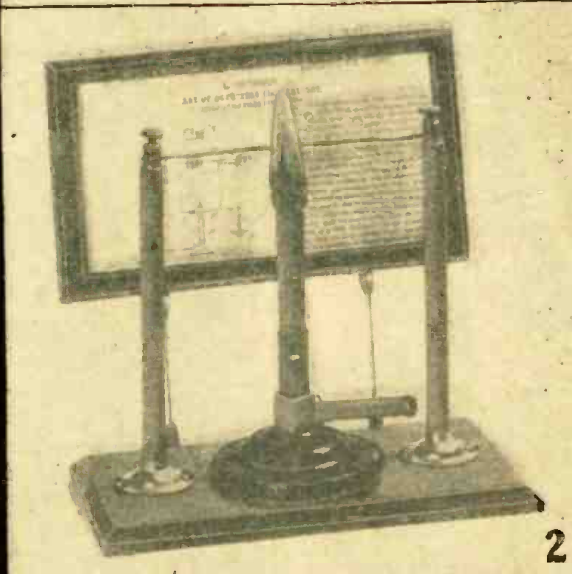

2

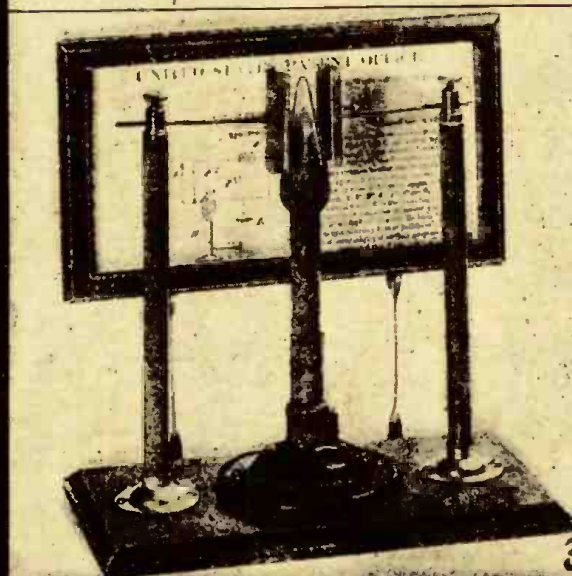

3



WHEN I first became associated with Dr. Lee de Forest in 1904, the dependable communication range of wireless was less than 100 miles. At that time he was driven by two ambitions—to increase the sending distance and to discover a better detector—with the greater stress on the latter. He reasoned that improved detector sensitivity would automatically increase the transmission range. None of the then current coherers, magnetic and electrolytic detectors did ever satisfy the rigid requirements and hopes of de Forest.

At this time a disaster (which upon closer analysis was not a disaster but a real blessing in disguise) occurred to de Forest. A court decision, in favor of Marconi, strictly enjoined him "to forever desist from the manufacture, sale or operation of any system of wireless telegraph."

Penniless, but not discouraged nor beaten, he rented a small, inexpensive space in the Parker Building, then located at the corner of Fourth Avenue and 19th Street, New York City. Here he started his renewed search for a "better wireless detector." Watches, clothing, and keepsakes were pawned. His brother Charles made razor strops with a special "lick-dob" on them for sharpening the blade, which I demonstrated and sold in Hageman's drug store window across from the old Grand Central Station as new experiments began and our hopes rose.

Ultimately the audion was invented as a result of brilliant reasoning by de Forest. Up to this time all known methods of reception depended upon or were derived from the three natural elements of water, earth, and air, notably metal filings, electrolytic fluids, and iron magnets. The possibility of using fire—the fourth and only remaining natural element—was at first unnoted, but the fluttering of a Welsbach gas flame in the

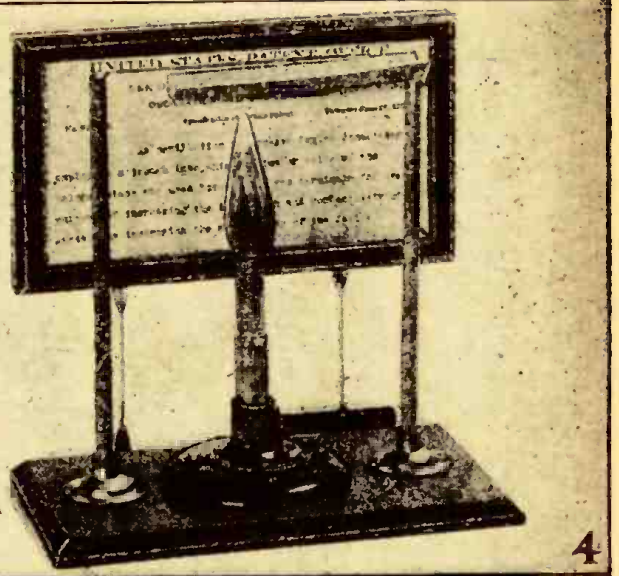

4



By Frank E. Butler



A first-hand account written by an assistant of de Forest throughout the hard years which immediately preceded the most revolutionary invention in all the history of radio.

presence of a spark gap was the miraculous and meager clue flashed by Fate to the keen mind which saw in it the path to his great discovery. His clue was the possibility that heated gas molecules might be sensitive to high-frequency electric waves. Such a theory was at least a *new creative thought*—not a copy or a follow-up of anyone else's idea. But, how to use it and with what? That was the real problem to solve. "Can heat hear?" was the first crude question! How was heat or gas or both to be fondled, handled, and nursed into a practical application?

As a result of de Forest's earlier preliminary tests, the fact was firmly established in his mind that the proper and only successful detector should operate upon the principle of relay action. According to this revolutionary idea some kind of automatic trigger device should control the local energy from a booster battery (from which the name "B-battery" is derived.) Activated by the incoming signals it would thus re-create the audible sound of the original transmitted signal. The plan was simple.

Assuming that a circuit were used in which the antenna impulses passed through a "gap of flame" to earth in the path of which there was inserted a telephone receiver—and provided there was even a breath of signal coming in over that route—why would it not be possible to boost or rejuvenate this feeble electrical impulse, to amplify it into audibility by the use of an electrical booster of dry cells—B-battery in embryo. With the inception of that

idea the famous and very essential B-Battery came into being, marking the first revolutionary advance in wireless since its beginning—a step as important to radio and electronics as was Franklin's discovery of electricity during an electrical storm by means of kite and key.

Dr. de Forest believed that if two bodies adapted for use as electrodes in a wireless receiving circuit be slightly separated, the space between them could be neutralized sufficiently to enable them to act as a detector of electrical oscillations. Provided that the intervening gap be put into a condition of molecular activity by the action of heat such a condition of ionic activity would cause what otherwise would be a nonsensitive device to become sensitive to electrical wave influences. His first impression was that this could be accomplished in free air, and so it first was done. There was no intention at the start to enclose the heating medium in a container of any kind, much less the thought of a vacuum.

Imbued with this revolutionary theory of using heat it was logical for de Forest to think of an open flame that would be small, concentrated, and adjustable. He selected for his experiments an open flame as generated in the common Bunsen gas burner universally used in research work.

Several standards of various types and designs for holding or suspending the necessary electrodes were made, equipped with binding posts on top to admit the ends of the wires. They were made so as to raise or lower the height of the extended terminals which later were placed in or adjacent to the open flame. A low-power transmitter was located on the other side of the room. In this case, the distance between the sending and the receiving points was of no consequence—the ability to receive something in the nature of a signal meant everything.

De Forest's basic problem reduced to its simplest form was threefold: What kind of heat to use? What kind of electrodes to employ? By what process could neutralization of gap be best obtained? He did not

FRANK E. BUTLER was born in Monroeville, Ohio, only a few miles from the birthplace of Thomas A. Edison. Like Edison, he started his career as telegraph operator from the same location and at the same age of 15 years. On June 10th, 1904, he resigned as train dispatcher on the New York Central to become associated with Dr. Lee de Forest in the young art of wireless telegraphy, and for many years afterwards acted as his chief assistant. In 1908 he organized The American Wireless Institute, the first school in the world to teach wireless engineering. Many present-day radio executives and engineers are among his graduates, and he points out that from the ruins of this pioneer school was started, in 1911, the forerunner of the RCA Institute. Mr. Butler designed numerous early radio circuits; was sales manager of several tube companies, among them Archatron, Volutron, Arcturus and Ken-Rad. He is known among acoustical engineers as an inventor in this and the moving picture field. Is a current writer for several technical publications and the author of books dealing with the progress of wireless, radio and electronics.





realize that the answer to these three questions would spell—radio tube! His original idea of a flame augmented by the B-battery, and his ultimate development of the three-element tube with its filament, plate, and grid, are identical in theory and operation—differing only in degree—an undying tribute to the brilliant genius of Lee de Forest.

In his initial Bunsen burner tests a live flame stood between and divided two electrodes with no physical means of contact (such as a wire or other metallic medium). The heat of the gas created the "phantom medium" over which the signal might flow. De Forest chose to call this phenomenon, *ionic action*, though he might as well have called it *electronic action*.

The illustrations show explicitly and clearly the line of reasoning de Forest followed from one test to the next, even though they do not include *all* the many experiments that were tried, only to be discarded later as being impractical or not applicable. *Those shown here constitute only the major steps.* They do not represent, in the slightest, the complete research and intense analysis of de Forest as he progressed methodically and confidently with his experiments. So thorough and extensive were his tests that he applied for patents—*not one but twelve!* The first five covered his experiments with an open gas flame.

Had de Forest been interested in copying any previous experiments of others, as is so often unjustly and untruthfully claimed by those *who were not there*, he naturally would have started his research with the bulb first, but it is significant that the sequence of his patent applications shows how unerringly he pursued the path of investigating heat as the *only* avenue to lead him to his goal—a path which scientifically could not have been traveled to success in any other way. This is a highly important historical fact.

In the first experiment (Fig. 1) a common Bunsen burner was lighted and adjusted to an intense blue flame. The metal frame itself formed one of the two terminals or electrodes, thus being a part of the electrical circuit. The standard holding the second electrode was moved so that its projecting wire entered the area of the flame near the center. Obviously the electrode which was placed in the flame was of relatively higher temperature than the standard itself which formed the other electrode. Thus was formed a local receiving circuit possessing a certain asymmetric electrical con-

ductivity which permitted the current from a few No. 6 dry cells to pass from the relatively cool burner stand to the more highly heated one. (Current in 1906 *always* traveled from positive to negative.) Fortunately the adjustment of the terminal wire in the flame during the first trial was *perfect*—quite by accident—otherwise no signal could have been heard. But there was no mistake about this! The signals were very weak, yes—but nevertheless they were *real* reproduced signals sent across the room.

This initial test brought out two important results:

First it proved that heat was effective in detecting wireless waves. Second it witnessed the birth of the B-battery—the importance of which cannot be emphasized too much, because without this simple adjunct our present-day radio and electronics would not be possible.

The second test (Fig. 2) was prompted by a query which in itself seemed trivial, yet it was fraught with great possibilities, as later test proved.

"If one electrode in a flame produced such promising results—what will happen if two terminals be immersed in the flame, and are different spots in the flame more sensitive than others?"

Then another test (Fig. 3) suggested itself. Instead of using two plain points of wires as terminals, why not employ "blinkers" or reflectors at the end of terminals, and deflect or concentrate the "ions" across the flame. Another test consisted of two wings—first plain flat pieces of metal, then perforated ones.

It was observed that the extreme outer edge or envelope of a flame appeared to be the most sensitive spot and there was a difference in signal strength between a cool wire just approaching or touching the flame and when, a moment later, that terminal tip became red hot. It was also noted that varying the voltage of the B-battery produced a marked difference in results. Every disclosure was startling in effect and heightened the curiosity and anxiety of de Forest to probe even deeper into this fascinating research.

The next test (Fig. 4) was a radical departure from the previous ones and illustrates the wide range of the inventor's imagination. This consisted of a trough-like electrode suspended horizontally above the flame. Various crystals of potassium, halogen sodium salts, etc., were placed in the trough, and when heated would emit different gasses or rarefied heated air. Parallel to this

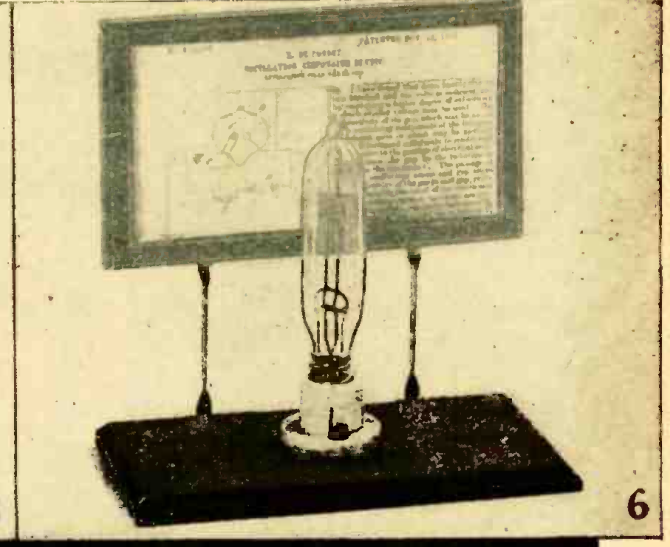
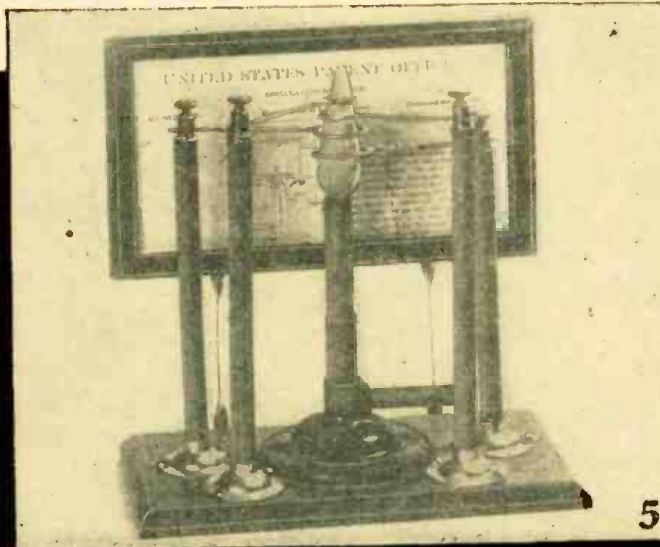



trough and above it was suspended a straight wire of the same length, this being the second electrode. The idea of using salts was to improve the sensitivity of the gap by further increasing its molecular activity. This was perhaps de Forest's inception of a "rarefied area" such as only an evacuated medium could produce—a radio tube in embryo.

Then followed the introduction (Fig. 5) of four terminals in flame arrangements. This time the ends of the electrodes were made with *rings* of slightly different circumference so that each terminal could snugly encircle the flame, one ring on top of the other and each leading to a different part of the circuit. This test again shows de Forest's original idea of keeping the high-frequency current path distinct and free from that of the local telephone current—the idea of separating the high-frequency from the audio circuits. It was in this experiment that de Forest obtained his first vague idea that the influence of high-frequency impulses could be impressed to better advantage on the conducting medium by means of a *third electrode* (the "grid").

It now seemed that de Forest was running into a log-jam among so many results—each of which presented its own set of baffling problems. The situation was bewildering—the search too intense. Anything might or could happen to precipitate a crack-up. It was this latter specter that haunted de Forest, for although he had learned a great deal about the action of heat and its relative importance to wireless detection, yet once again it was a whiff of air that turned the tide against him just as it was a whiff of air that feebly fluttered the Welsbach burner that originally inspired him. He had observed that the slightest draft of air could blow the flame out of its delicate adjustment—thereby altering the action and rendering the reception unstable. This observation sent de Forest into despondency as it convinced him that no matter how successful his flame tests might be—or whatever type electrodes he might use—its practical use, as for instance on shipboard, was impossible. At last—the realization that the dead end of a street had been reached.

The instability of an open flame and its susceptibility to drafts then caused him to shift to *another type* of heat-producing medium in an attempt to find the necessary steadiness. There seemed nothing quite so handy, practical or promising as a lighted incandescent electric lamp.

The first thing to be decided was the voltage and the number and kinds of electrodes to use. It was de Forest's intention to follow the series of bulb tests along the same sequence as was done with the flame. It would take longer, but at least give the benefit of comparisons. A Christmas tree lamp with its small candelabra base and low voltage was considered the most advantageous type. This style of lamp was obtainable locally from a manufacturer named McCandless Incandescent Lamp Co. However, making up only two or three samples of electric lamps which possibly would burn out after only a few moments' trial presented a real financial problem. It required unusual skill on the part of McCandless to construct the various electrodes and then to evacuate the tube with a hand pump before sealing. Sample after sample was discarded and yards of glass tubing sacrificed before the first crude specimen (Fig. 6) was produced. Then followed bulb after bulb, made along the same lines as the previous flame-tests. Each produced varying degrees of good or bad results—representing a maze of baffling problems. Then followed a test with a tube in a horizontal position (Fig. 7) designed with a small cup on the bottom which held a portion of mercury.

The next test, using two wings (Fig. 8) is especially significant. It is not only the original amplifier, but it also introduced for the first time the use of a "bias C-battery" clearly shown in the patent drawing with

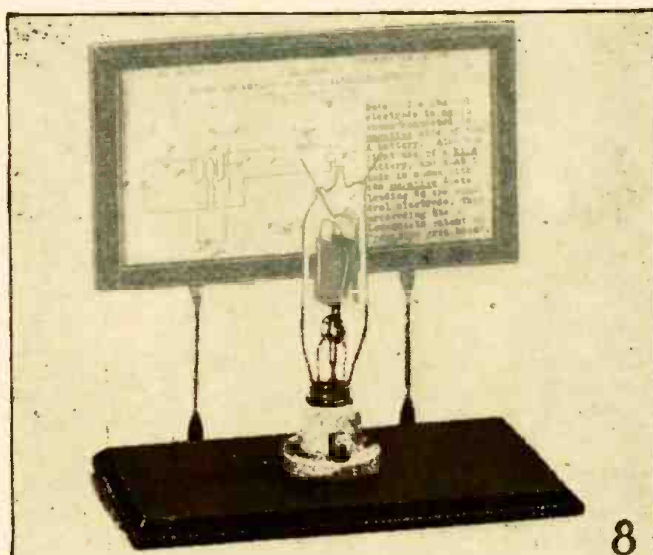

8

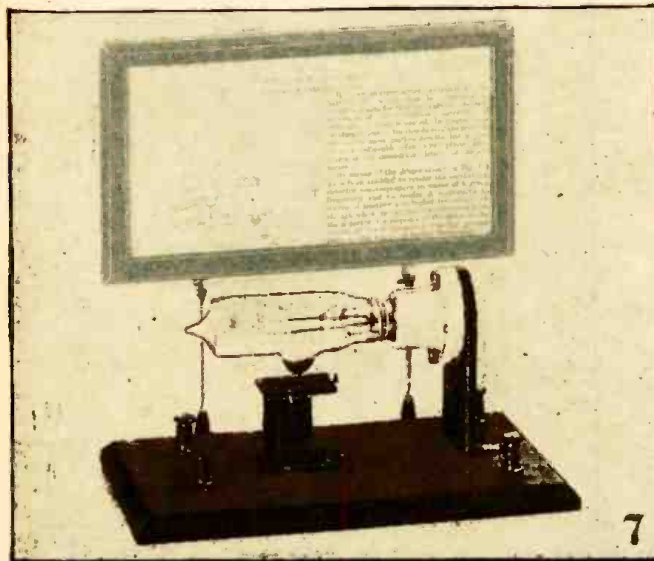

7

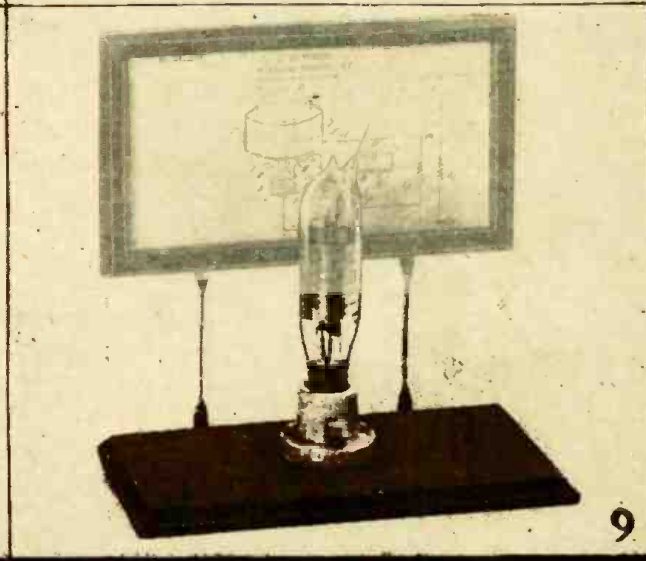

9



its negative plate leading to the control electrode—unassailable direct evidence that the idea of “negative grid bias” positively was originated by de Forest (though it later meant a fortune to those concerns controlling the Lowenstein patents).

With this idea fresh in mind de Forest next tried a tube having only one wing and filament. He pasted a strip of tin foil on the outside of the tube (Fig. 9) which he used as one electrode—but this produced no favorable result. A safety razor blade was lying within reach. Preoccupied with many thoughts de Forest carefully cut the tinfoil—round and round—into a long spiral piece like a spring, without changing its location where it was pasted. This simple act had the effect of making a *coil of flat metal* instead of a flat plate—two quite different and distinct things electrically. This was hooked up and tried. The result was startling. Hopes rose. This also was the time a 6-volt storage battery with adjustable resistance was used for filament supply. Likewise the amount of B-voltage was set at 22½ volts with a potentiometer for varying its potential—two items that remained standard in future radio circuits for many years afterward.

Experiments were continued with a wire instead of a tin-foil spiral. De Forest figured he had too much wire wound around the tube, which luckily was a sturdy one, able to withstand the series of additional tests. Signal strength continued to increase as he kept constantly snipping small pieces of the coil to reduce its length.

Finally when only about 1¼ inch remained of the original coil—not even enough to completely encircle the glass—he obtained his greatest results, and he stopped there. Feverishly he took this small length of

wire and with a pair of long-nosed pliers bent it into a flat zig-zag shape having the over-all dimensions of the flat ⅝-inch wing. This was taken over to McCandless. Dramatic and intense moments followed.

“It is my impression,” said de Forest, “that if we take this zig-zag wire and place it *on the inside* where it will be closer to the hot filament and the cold wing we’ll notice a decided improvement. *In fact I believe the closer we group the three elements the more effectively they will operate.*”

At this point de Forest sketched the idea he had in mind. Here again was shown the *third* or C-battery in the input circuit. This indispensable C-battery, like its big brother B-battery were both discovered and used before their famous sister the *grid* came into existence!

Several sets of tubes were made with the elements in different locations. Each was carefully tried. One of these was made with the zig-zag wire interposed between the filament and the wing. By a streak of fortune this was the last one to be tested.

Disconnecting the previous tube, de Forest reached for the remaining specimen that was still resting in the old shoe box filled with cotton batting in which it was brought from the McCandless shop.

In that unforgettable moment, de Forest gently held this remaining tube in his hand as if he had a premonition of what promise it had in store for him—and mankind. When all was in readiness again, he called across the room saying:

“O.K., Frank! Let’s have some signals!”

Immediately I started sending the familiar “Dash-dot-dot”—of the letter D with the same monotonous action I had been accustomed to for years, with no special thought that this was an exceptional occasion. Two or

three D’s had been made when my senses were jarred by the wild, almost frantic yell from de Forest saying:

“That’s it, Frank! My God, you ought to hear those signals! I never heard such perfect D’s before—Here take these phones quick and let me send it to you.”

He dashed toward the transmitter—passing me as I rushed for his headphones where I too listened in amazement at the quality and strength of signals.

At last de Forest’s dream had come true. That moment saw the birth of the “three-element vacuum tube” (Fig. 10). Our “better detector” had become a reality.

The life of that pioneer tube was scarcely *three minutes* before it burned out. In that short and glorious life-span it had accomplished what none of the human race had ever seen or heard since creation. It was the first messenger from Cosmos chronicling the harnessing of the electron. Its sound, though weak, was strong enough in its message to echo throughout all future ages. Its infant range was merely the length of a dingy room—a far cry from that of its offspring today which girdles the earth and reaches into the infinite space of the planets.

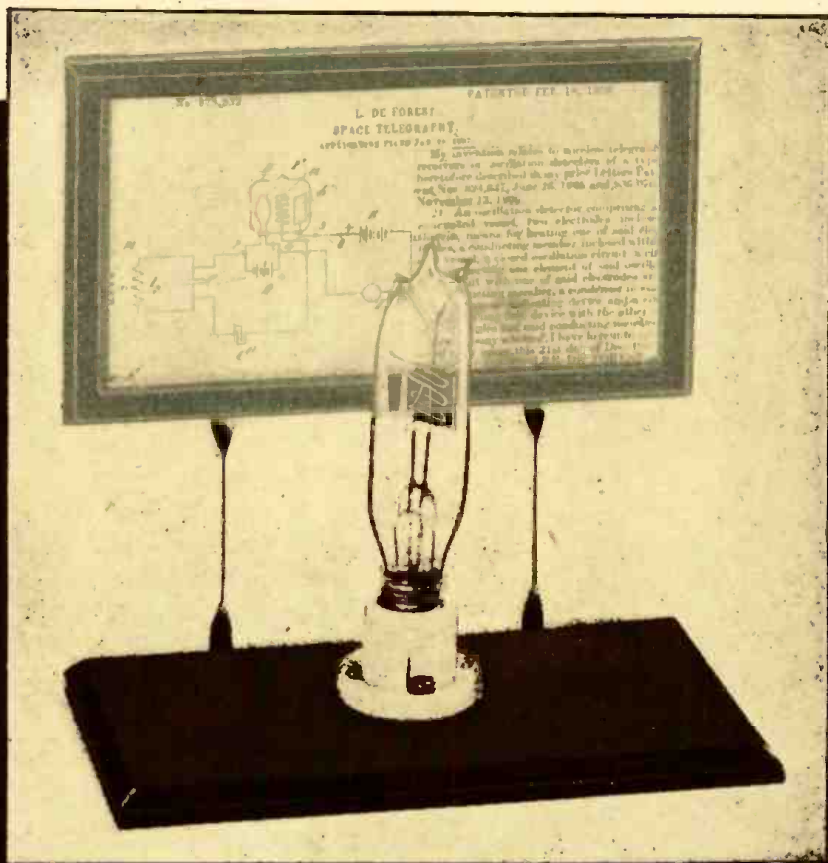
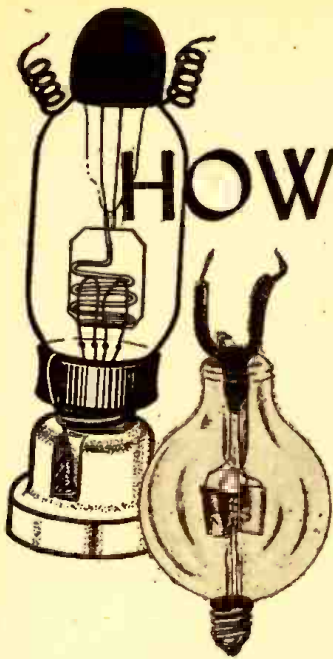

Fig. 10—End of de Forest’s long search for the better detector—the original grid audion.





# HOW AUDIONS WERE BUILT

By Gerald F. J. Tyne



YOU AND your factory foreman . . . put the invention in practical

Babcock or de Forest, who called these devices "audions." These were all essentially two-electrode devices (filament and anode) and the lead to the anode was brought out through the wall of the glass bulb, sometimes at the top, sometimes at the side.

## The First Order for Audions

working shape and handed to the world a useful device . . . a more meritorious act than the simple dreaming that it could be done." So wrote Lee de Forest's assistant, C. D. Babcock, to H. W. McCandless on December 9, 1913. Behind this letter lies one of the greatest success stories of the early days of radio, a story unfortunately not too well known.

In the fall of 1906, de Forest and Babcock ordered a large quantity of tubes, all alike. When McCandless received the large order, he assumed that these men had at last found exactly what they wanted. However, they returned in December of that same year and asked him to make up more models, this time with a zigzag wire grid between the filament and the plate, or "wing" as it was called at that time.

Henry Wallace McCandless, guiding genius of the firm of H. W. McCandless & Company, Inc., was graduated in mechanical engineering from the University of Illinois in 1890. In 1895 he founded his company and engaged in the manufacturing of miniature incandescent lamps at 67-69 Park Place, New York City. In the ensuing years he built up a reputation for being able to make special lamps of all types. His work and reputation were such that large lamp manufacturers referred their orders for special lamps of unusual design or characteristics to him. Because of his knowledge of materials and the techniques of handling them, he was able to fulfill the most bizarre requests. As he developed new techniques for handling glass and metals, he also made lamps of his own design for special applications. Few realize that even in the field of surgery part of the progress made in those days may be attributed directly to the lighting developed by McCandless.

The earliest of these "grid-type" audions had carbon filaments of the treated type, the grids and wings were of nickel, and the bulbs were cylindrical. They had single filaments, but double filaments were soon introduced, and the records of the McCandless Company show that the first double-filament types were made in 1906.

## Experimental Pre-Audion Tubes

When Dr. de Forest and his assistants were struggling with the idea of the audion, it was but natural that they should turn to the foremost lamp-maker of the day to have their models made. Toward the latter part of 1905, C. D. Babcock, one of de Forest's assistants, came to McCandless with a crude lamp and asked if he could duplicate it. The sample had a flat anode and was unbased. Babcock said that de Forest was working on a wireless telegraph detector, that he had tried an experimental form using a gas flame, and was now desirous of replacing the gas flame by an incandescent filament.

Accepting Babcock's order, McCandless cut the sample apart and made six copies of the model. These bulbs had a carbon filament and a nickel anode. Two days later Babcock came back and brought de Forest with him to discuss the bulbs.

While the first order was a duplication job, subsequent orders were for bulbs made up in accordance with sketches, usually extremely rough ones, provided by



Henry Wallace McCandless, who built the first audions.





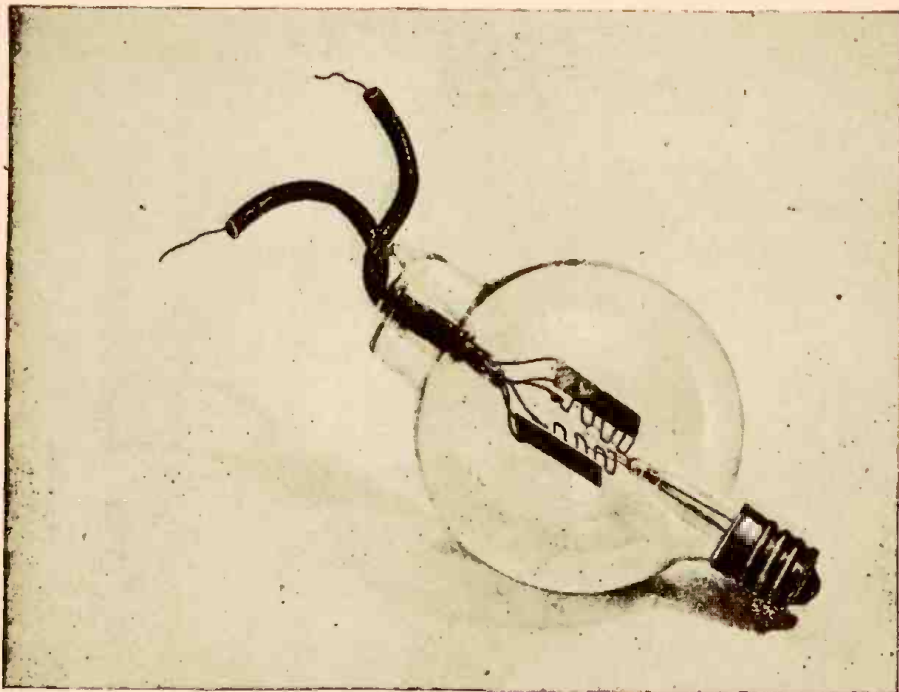

Early double-filament, double-grid and double-plate audion, now owned by Louis G. Pacont.

The first double-element type (plate and grid on each side of the filament) was made in April 1909, but the single-element type continued to be made for some years thereafter. These double-element tubes were known as "double audions," and were sold by de Forest at a higher price than the single-element type. A number of these double audions are shown in the attached photographs.

#### Contributions by McCandless

It was evident to McCandless that these men were experimenting and as usual he drew on his wealth of knowledge to make suggestions as to

how the tubes might better be made. The earliest tubes had all the elements mounted on a single stem, although the leads for the grid or wing, and sometimes for both, came through the side of the bulb instead of through the "press."

McCandless and his shop superintendent, Jacob C. Grogan, felt that the audion would not become a commercial product until the tubes were designed with the grid and wing on one stem, and the filament on another. The purpose of this was, first, to keep the leads separate and, second, to save the loss of audions due to burning out of wire filaments during exhaust. With the double-ended

assembly it was easy to cut off the stem of the bulb, splice on a new neck and seal in a new filament and stem, thus saving the bulb.

While this development work was going on, McCandless was working on another project. For a long time he had wanted to make a satisfactory incandescent lamp to operate at two volts, so that it could be used on a single storage cell. The characteristics of the available carbon filaments would not permit this, with the filament diameters available. The filament had to be so short that only the center part glowed, the temperature of the end portions being reduced by conduction of heat through the supports.

#### Improvements in Filaments

In 1906 a friend brought from Germany one of the newly-developed *tantalum*-filament, 110-volt incandescent lamps, which were then little known in the United States. McCandless broke open this lamp, and using approximately 1/55 of the length of the 110-volt filament, made up a two-volt lamp which was successful. He then tried to obtain additional tantalum wire from Siemens & Halske, with the understanding that it was for use in lamps operating at less than ten volts filament. Although he made some progress in the early stages, negotiation was never successful because of patent difficulties. He did manage, by working through the Association of Lamp Manufacturers, to get limited amounts of this wire from the General Electric Company.

McCandless decided to try tantalum-filaments in the audion. It was a

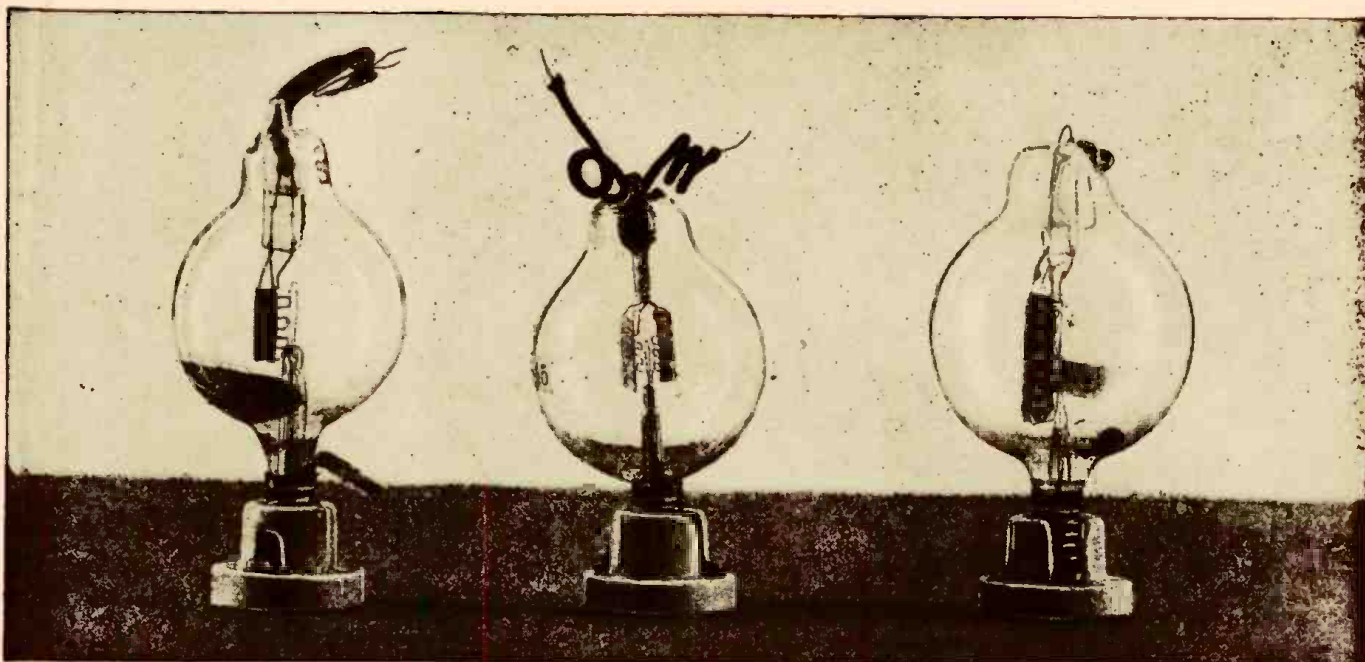

Three evolutionary steps. Left is 1908 audion, center a 1910, and right a 1912 type.

Courtesy G. F. J. Tunc



good inspiration, since it improved the electrical characteristics considerably, but it had its disadvantages. It was not stable in position. When heated it would not remain in a plane, but would twist around to such an extent sometimes as to touch the other elements. The important thing was that it could be made to operate at four volts. Carbon filaments required at least six volts for satisfactory operation.

About this time tungsten filaments came into the picture, and McCandless, ever on the lookout for methods of improving the quality of the audions he made, tried them. The tungsten filament of that day proved to be little better than carbon and far inferior to tantalum.

The suggestion was made—by whom McCandless does not remember—that a tungsten filament be used because of its rigidity, but that it be wrapped with tantalum to get good emission. Always open to suggestions, McCandless tried this expedient. It was successful. The combination was as good electrically as pure tantalum and as good mechanically as the carbon filament.

Soon after the first tubes were made for de Forest, in 1905-1906, a young man came to McCandless and wanted to buy some audions. McCandless consulted de Forest who told him: "Sure. Sell them to him." This McCandless did, and the word spread, so that more and more tubes were sold on an over-the-counter basis.

One of these customers, who first came to buy shortly after McCandless had introduced the tantalum-wrapped tungsten filament, was Dr. Walter G. Hudson, an enthusiastic amateur, then chief chemist for du Pont. McCandless showed him the audions with the tantalum-wrapped filament and told him that the wrapping was an extremely tedious and time-consuming operation. Hudson bought some of the tubes, and after he had used them came back to McCandless and said:

"I have an idea. Let me try it, and if it works I'll patent it and go fifty-fifty with you if it proves saleable."

Hudson's plan was to grind the tantalum to powder, make a paste of the powder by adding a binder, and applying the paste to the loop of the tungsten filament. Hudson provided the paste and the audions made in this manner were very satisfactory. In fact the "Hudson filament" type soon became the "standard" audion.

During these years of development work on the audion, McCandless was not focusing his attention on materials alone. He was also experiment-

ing with the shape of the tube and the positioning of the elements therein.

### Better Pumping Equipment

The early audions were made with the vacuum ordinarily obtained in the incandescent lamp of that day. When McCandless began to manufacture miniature lamps, he used an exhaust pump of the "Packard" type. Later he added so many improvements to this that it became known as the "McCandless pump." At that time no pressure gauge was used on the pumping equipment. To determine when the proper vacuum was attained the mercury valve which checked the back-rush of air into the pump was watched. The tubes were pumped until practically no bubbles appeared at that point. The bulbs were checked for leaks with a high-tension spark-coil device, commonly used by incandescent lamp manufacturers for that purpose.

De Forest kept demanding higher and higher vacua in the audion. Later, for higher vacua, the tubes were baked in an oven to a very high temperature while still on the pump. In some cases the bulbs were heated, by the direct application of a Bunsen flame, almost to the collapsing point. This was done to expel all the gas occluded in the glass bulb.

A few years later, in August 1910, McCandless replaced his pumping equipment with two rotary pumps of the Gaede type (not the Gaede molec-



Courtesy R. McV. Weston, F.R.P.S.  
A 1907 audion, once owned by J. A. Fleming.

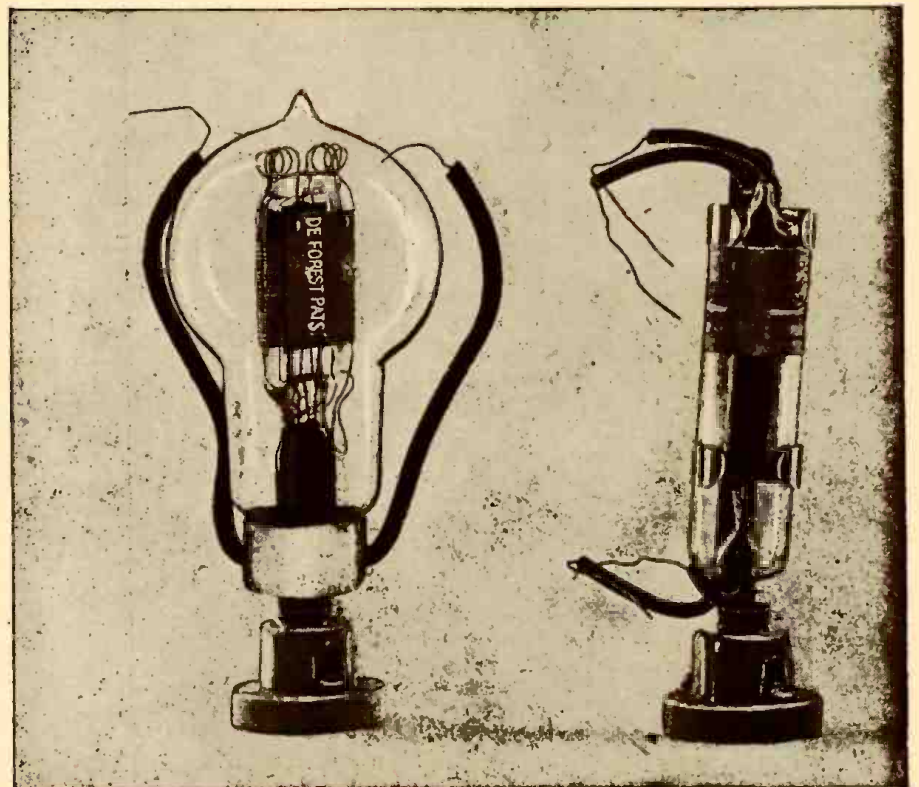

Courtesy G. F. J. Tyne  
Left—An early de Forest "Singer Type" audion. Note the metal base. Right—An Ultraudion with Hudson filament mounted in an adapter to permit operation in candelabra socket.



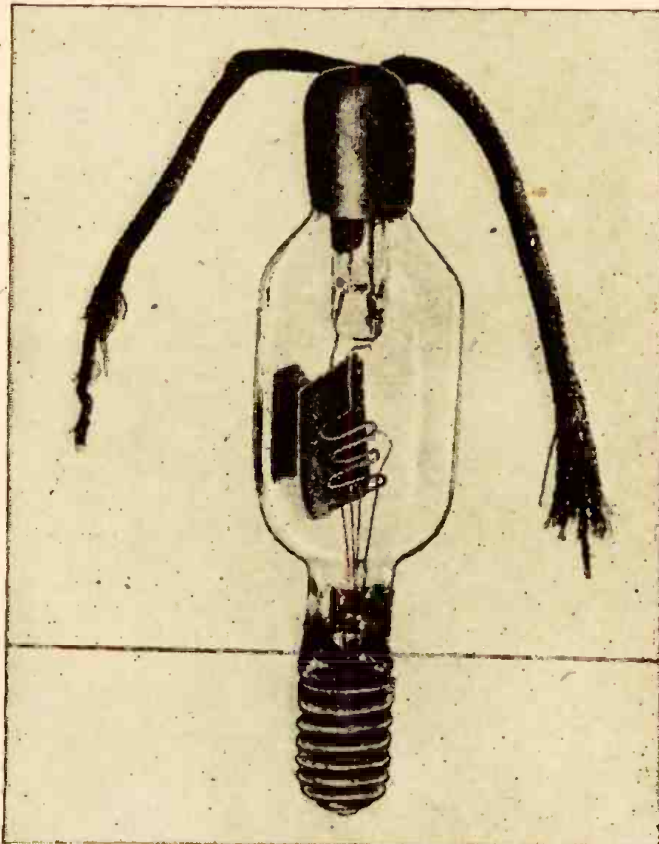

Courtesy Clark Historical Library  
Very early type of three-electrode audion, made in 1907 and 1908.



Reconstruction of the 1907 appearance of the building at 67-69 Park Place, New York City, where the first Audion was made by McCandless.

ular pump). A third such pump was added in February 1911. De Forest continued to demand higher vacua in the audion and sometimes returned the bulbs for re-evacuation, complaining of a lack of "sensitiveness." Grogan insisted that the lack of sensitiveness was caused by pumping the tube to too high a vacuum. This was particularly the case while de Forest was on the West Coast with the Federal Telegraph Company, where he was trying, in 1912, to make the audion function as an amplifier.

### Detector vs. Amplifier

Here is a confusion of the terms "sensitivity" and "output." In the case in question de Forest, on the West Coast, was trying to get high output by operating at high anode voltage. The tubes would not give output, hence he said they were not "sensitive." What he meant was that he could not get the desired amplification at high power levels because of ionization of the residual gas. The gaseous tubes advocated by Grogan and operated at low anode voltage would *detect* lower voltages but would not give high power output.

McCandless made a number of audions for the Federal Telegraph Company while de Forest was with them.

In the fall of 1912 de Forest came east with a view to interesting the telephone company in the amplifying properties of the audion, for its use as a telephone repeater. After he had demonstrated the device, de Forest left the apparatus with the engineers of the Western Electric Company, and gave them permission to purchase additional bulbs from McCandless for their experiments. McCandless made for them two types of bulbs. The first was a tantalum-filament double audion, and the second a single audion, but having larger elements and a larger bulb, with a longer, higher-voltage filament of tantalum. These tubes are shown in the photographs. The larger elements were used at the suggestion of Grogan.

Some time prior to 1912 the Marconi Company took official cognizance of McCandless' work on the audion. Mr. R. W. Sammis, then chief engineer of the Marconi Company, in a preliminary telephone conversation offered to give McCandless the job of making Fleming valves for his company, provided he would stop making audions for de Forest. Sammis later wrote McCandless a letter transmitting to him a copy of the Fleming patent and stating that it covered the audion and in fact any



type of rectifying vacuum detector. McCandless consulted an attorney, Charles McCandless (not a relative, however), and they studied the Fleming valve patent. Meantime, after the telephone conversation, but before the letter from Sammis, McCandless became very much concerned over the situation and wrote de Forest about it. De Forest replied, on March 2, 1912, giving a list of the patents covering the various embodiments of the audion, and assuring McCandless that he was fully protected. McCandless obtained copies of all the patents, and after due consideration decided to continue the manufacture of audions.

Sales to the general public were negligible after 1913. De Forest started to make tubes himself at his High Bridge plant and "bootleg" manufacturers started up. McCandless never advertised or solicited trade in audions. He continued to make special bulbs for de Forest or any other customer who came to him with a problem which was a challenge to his genius. He sold his business to the Westinghouse Company in 1914 and entered their employ as

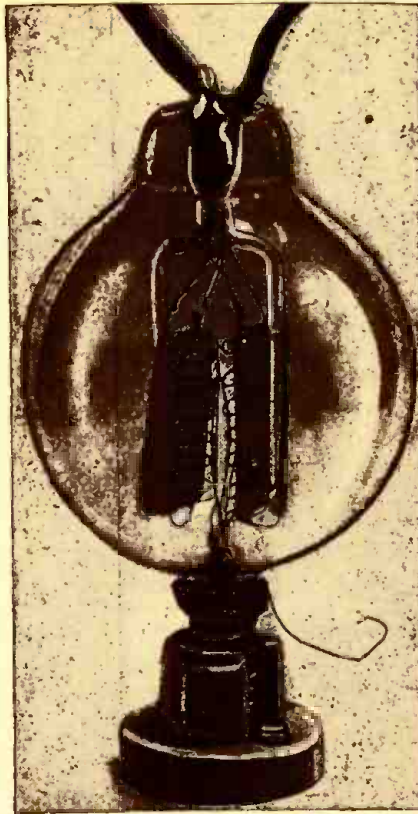

Courtesy G. F. J. Tyno  
A 1916 tube, last of the screw-based audions. It was made at de Forest's Highbridge plant.

manager of the Westinghouse Special Lamps Division.

To this day the concluding paragraphs of Babcock's letter written about that time must bring back a stirring flood of memories to McCandless:

#### The Tribute from Babcock

"The mechanical and electrical development of the device from those crude designs of mine to the perfect instrument of the present day should and does stand as a monument to the skill, patience and technical knowledge of your Mr. Grogan. Particularly valuable was his disclosure to de Forest that the audion should not be exhausted to a vacuum known as 'hard,' but rather should be 'soft,' that single fact took the device from the ranks of failures and put it in the category of successes.

"Facts are stubborn things, and the above are some of the stubbornest in the history of this instrument. The great pity is that the thing never became more generally used so that you could reap the reward due you for the part you and your staff played in its development."

DE FOREST AUDION



1907-1947

## Three Anecdotes of the Audion's Early Days

### How the Grid was Named

During the early experiments with the first crude handmade radio tubes it was the custom of Dr. de Forest to give directions to his assistants somewhat in the following manner:

"Here . . . hook this to that—and that to this. Bring this wire over to that post and move this over there."

In the rapidly shifting tests it was at times, difficult to differentiate between what was "this, that or the other thing," so one day, in a state of exasperation, an assistant impulsively asked:

"Doc, why don't you name some of these parts so we'll know what you're talking about and what we are doing?"

"All right," snapped de Forest in reply. "You know what the filament is and which is the 'wing' (now known as 'plate') so we'll call this other jigger—the GRID,—because that's what it looks like—a roaster grid." Then, quickly adding, as if it were equally important:

" . . . and remember this . . . in fact make a sign and paste it on the wall: REMEMBER, GREEN TO GRID and Red to Wing."

To this day that order has never been countermanded and we find that in every country in the world where elec-

tronic circuits are planned or used the "lead to grid" is always specified in the color code as—GREEN!

### De Forest's Nickel

One day as Frank Butler was entering the open door of Dr. de Forest's laboratory in the Parker Building he hesitated at the entrance and saw no one inside. Just as he was about to step forward across the threshold a slight sound came from behind the door and he heard the voice of de Forest unconsciously muttering to himself these words:

"Humph! I don't know whether to get a sandwich with this nickel or to buy a pad of writing paper. . . ."

In an instant the two were facing each other and the sudden, unexpected meeting took de Forest so by surprise that he dropped the precious coin so it rolled underneath the nearby empty shipping boxes which constituted the workbench. This placed the inventor in the predicament of not knowing which to do first—retrieve the coin or greet Butler who was then returning from an out-of-town visit.

This is but a sidelight upon the impoverished conditions under which Dr. de Forest was often compelled to exist in those early days.

### Navy and the Audion

A short time after the first few audions were made, Dr. de Forest took his original mahogany receiver cabinet with the "peep window" in front, together with a seven-plate Witherbee storage battery to the Navy Department in Washington hoping to interest them in his new discovery. The story of how "they entirely missed the boat" is a classic example of many similar incidents ascribed to dumb officialdom.

The several officers rendered an unfavorable decision based upon six counts:

1. The device can in no way be of service to the department either on land or sea.
2. The device is found impractical.
3. It is undesirable on shipboard because the motion of the ship at sea would permit the battery fluid to escape from the vent holes of the battery, splashing the acid on and ruining the deck of the wireless room.
4. The price of \$30.00 is excessively high in comparison with a good crystal detector.
5. The device is short lived and bulbs would have to be replenished too often.
6. It is regarded as unreliable and unwanted because it is too new. It is untried. *It is not Standard Equipment.*



# DE FOREST AND THE NAVY

By George H. Clark



R. LEE DE FOREST and the wireless companies bearing his name have been associated with the United States Navy's wireless communication system since its early days, and in the opinion of the writer have had more direct and indirect influence on the development of the Navy's wireless than has any other person or company up to the beginning of the recent war.

One honor is not his, however—that of first introducing the U. S. Navy to wireless communication. That is reserved for Guglielmo Marconi, who came to the United States in the fall of 1899 to report the International Yacht Races by wireless. The Navy Department appointed several officers to observe and report on this work, and the first wireless message in the Navy's history was sent by Lieutenant Blish, U.S.N., on September 30, 1899, from the Marconi-equipped observation vessel, the

S.S. *Ponce*, via the Lighthouse Service Station at the Highlands of Navesink, N. J., first U.S. shore station.

Four years later, however, de Forest came into the picture, submitting to the Navy one of his sets for competitive test against those of Slaby-Arco, Braun, Rochefort, and Ducretet. The Slaby-Arco set worked 70 miles from shore to ship, de Forest's only 42; the others made no record worth mentioning. On the basis of distance attained, the contract went to the German concern.

### De Forest Equipment Better

As a matter of fact, de Forest's set was in some ways far superior to that of the Germans, although this was not recognized by the Navy authorities at the time. Two of the features which he submitted were later adopted as standard: (1) *the use of alternating current as a power source instead of the interrupted direct current used by Slaby*; and (2) *the use of a self-restoring detector*

*with telephonic indicator*, as opposed to the Slaby coherer. The Navy considered the use of the coherer, with its tape register, essential for the relatively untrained Naval operators of that time. The message could be read off slowly from the tape at any time after its receipt if the operator were not sufficiently trained to copy it directly from the buzzing sound of the decoherer. Also—an important factor in those days when operators were few—a bell could be switched into the circuit instead of the recorder, to call the operator if he were away from the set or if messages came in during his sleeping hours.

The advantages of the alternator which became painfully obvious after Navy men had spent weary hours cleaning the mercury-turbine interrupter of the Slaby system, were not appreciated (or rather foreseen) in the early experiments.

One of the early tests of de Forest sets was held between the Naval Academy at Annapolis and the Washington Navy Yard, and during the work the Secretary of the Navy visited the former site on an official inspection. The Secretary suffered a slight accident at the time — some sources say he tripped over a wire, another that the horses drawing his carriage ran away; but at any rate the de Forest operator, Harry Mac Horton, sent a little story on the event to de Forest in Washington. The latter, even then publicity-conscious, rushed up the narrow street to the Navy Yard gate, and telephoned the news to the Navy Department, whence it was sent to the local newspapers. Thus the "first press story" by wireless was in the Navy's realm, using de Forest apparatus. Nor was it the last!

The Slaby system soon became antiquated, and in time American manufacturers were given orders for sets. Thus such well-known inventors as Fessenden, John Stone Stone, and (by no means least) de Forest began equipping Navy ships and stations. As early as 1906, there were 12 de Forest spark sets in use by the Navy.

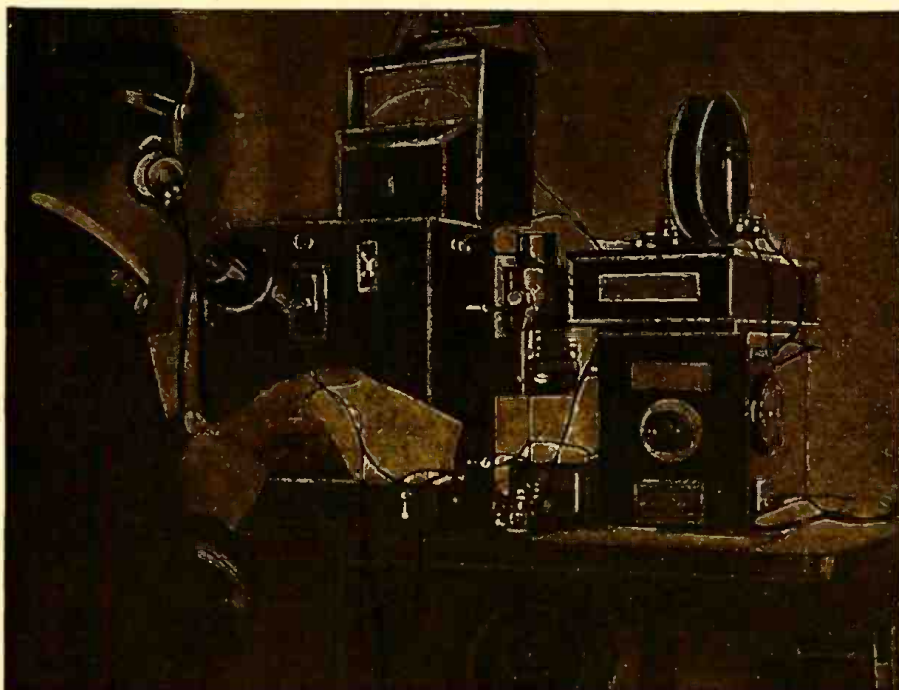

Courtesy Gerald F. J. Tyne

Lt. Weaver using the de Forest radio telephone aboard the U. S. flagship *Connecticut*.



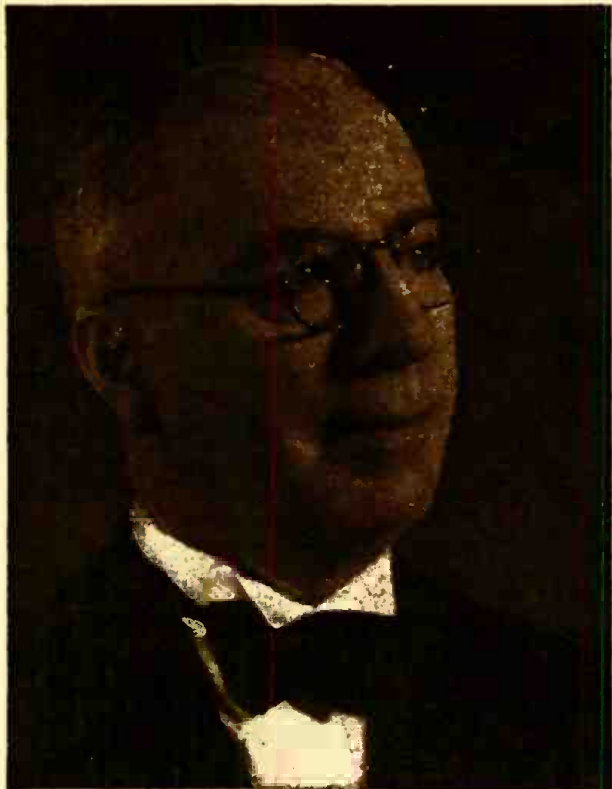

**G**EOERGE H. CLARK is one of the earliest of radio pioneers. He was the first radio-man to be graduated from the Massachusetts Institute of Technology (in 1903). Joining the Stone Telegraph and Telephone Co., he remained till 1908, when he became the Navy's "Sub-inspector of Wireless Telegraph Stations." He remained with the Navy till after World War I, when he joined the Marconi Wireless Telegraph Co., remaining with it and its successor, RCA, till his retirement from active work in 1946.

From the time he started with the Navy, Clark's work led him to value the importance of the written record. First setting up specifications for apparatus, then installing a system of type numbers for equipment, he was drawn more and more toward "a bookish career" till he became the official historian of RCA and the semi-official historian of radio in the United States. His collection of records amounted to more than one hundred volumes when he left the Navy, and has been supplemented since then by purchase and gift. Therefore his article is based on something considerably more solid than recollection, and as such, has more than usual authority.

Three of these, the 25-kw shore stations installed in the Caribbean and at Puerto Rico, made spectacular records, the last-named being able to communicate directly with the de Forest commercial station at Manhattan Beach, N. Y., a distance of 1,600 miles. This was of course (as we used to say in those days) "at night, in the winter time," but it was a record nevertheless. The U.S.S. *West Virginia*, equipped with a de Forest set, while en route to the Canal Zone with President Theodore Roosevelt on board carried on wireless communication with ships off Key West, about 1,050 miles away. These were remarkable feats for the time and the apparatus. Nor were these isolated cases; they were repeated many times.

Much of the success of the de Forest spark transmitters was due to three things: his appreciation of good grounding (at Key West his ground plate was deeply laid, in water, but the water happened to be a man-made lake, with coral between it and the ocean; not until a hole was broken through to the latter did the station begin its record-breaking work); his use of a very large primary condenser and a short spark, thus lessening the resistance of the latter and making for more sustained oscillations; the fairly loose coupling obtained, due to the large primary condenser, between primary and secondary circuits, even with a direct-coupled set. In addition, the large

condenser gave him multiple discharges and hence a spark note more easily readable over static and over the lower tones of sets such as those of Slaby.

This was the peak of de Forest's success with spark sets. He soon was surpassed in technical ways by Stone's loose-coupled sets, with strictly uniwave transmission, and by the giant Fessenden set installed at the Navy's first high-power station, NAA, at Arlington, Va., with its 500-cycle supply and a rotary synchronous gap.

#### Navy Vacuum-tube Equipment

De Forest, however, was merely biding his time to go forward to greater successes by a different means. His first crude experiments with a vacuum tube, first as a detector, then as an amplifier, and finally as an oscillator, in time lifted radio to a new era, and his little nickel grid proved to be the electrical lever which would move the radio world. There was a gap between the spark era, with its use of trains of waves, and the later vacuum-tube era, this gap being filled for a time by the continuous-wave Poulsen arc system as developed by the Federal Telegraph Company. Even this intermediate method owed much of its success to de Forest adjuncts. In time, also, the arc passed out of the picture, and the vacuum tube reigned supreme in all fields of radio. Leaving out all matters of controversy, broadly speaking it was de Forest's

invention of vacuum-tube control by means of a grid that caused the vacuum tube to become the universal tool for radio in transmitting, receiving, and amplifying.

De Forest's first contact with the Navy along these lines was before he had brought forward the grid, however. He made his first Government sale of vacuum tubes in 1906, to the United States Navy, in the form of a complete receiving set fitted with audion detectors, with candelabra base. These were, however, of the two-element type, with plate and filament only. These, as well as the three-element forms which soon followed, bore the name "audion," however.

In 1907 he came closer to the final goal, in that he introduced wireless telephony to the Navy, and with it the three-element audion. In November

of that year the famous voyage of "Fighting Bob" Evans' fleet around the world took place. De Forest interested the Navy in having a wireless telephone installed on the

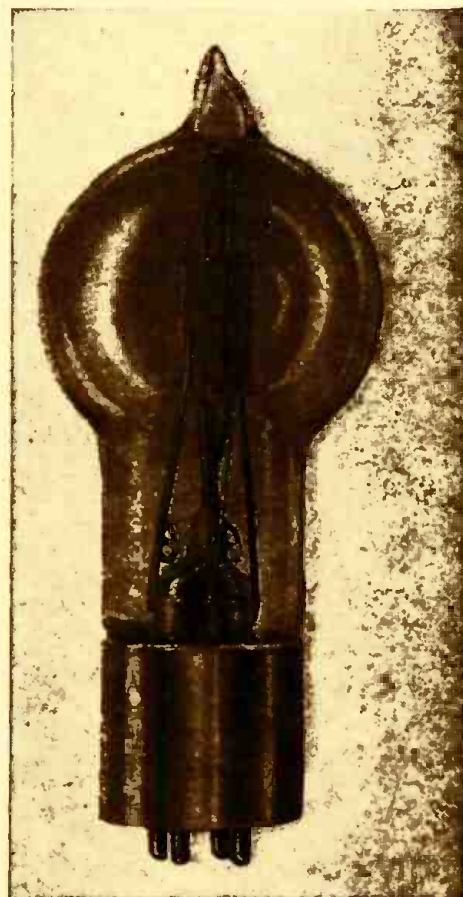

Courtesy Gerald F. J. Tynce  
De Forest "Singer Type" tube used by Navy.



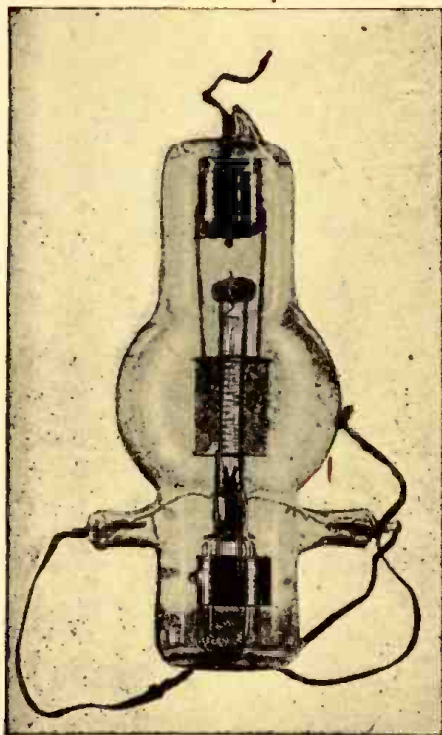

Courtesy Gerald F. J. Tyno

The Type H was a 150-watt transmitting tube.

bridge of the principal vessels in the squadron, so that officer could speak with officer without an operator-intermediary. This idea, which was technically and strategically correct, failed, for several reasons. First, the standard wireless telegraph set and the new telephone could not operate simultaneously, duplex-duplex operation not having been provided nor indeed thought of. Second, the "new-fangled" installation required a technical man to keep it in operation, and in those days such men were operators, not officers. Other difficulties were present, as might be expected in a pioneer installation, so that the idea did not work as well as its deviser had hoped, yet many good results were obtained with it. One of

these was the "broadcasting" of phonograph records by then Chief Electrician H. J. Meneratti from the U.S.S. *Ohio* to her sister ships, during many nights of the world voyage. This story alone is most interesting, but space does not permit further description.

Not long after this world cruise, de Forest presented the audion to the Navy's attention for use as a detector, and little by little it became more desired; sales became more frequent. An official accounting made for later court proceedings lists a sale of 1,000 single plate and grid audions at \$2.50 each, sold on contract dated January 12, 1914; 500 oxide filament tubes, at \$12.50, on October 5, 1916; 1,000 ultraudion and amplifying tubes, double plate and grid, at \$4.00, on September 25, 1917. These were not the first, nor the last, nor the total of the sales, but are mentioned to give a general idea of usage and price.

There was, unfortunately, one bone of contention between "Doc"—as de Forest is called lovingly by his friends—and the Government from the beginning; he contended that "a little gas in the tube was a good thing," whereas the Navy said it was not. Both were right! De Forest was in some ways an amateur at heart, and sold his first tubes to amateurs. These eager lads wanted the greatest sensitiveness possible, and were perfectly willing to juggle filament current and plate voltage to obtain it. That such tube conditions did not make for stability bothered them not at all. But it did bother the Navy; each tube had to have the same constants as its mate, so that if a tube burned out during reception of an important message a second could be switched in and used immediately without readjustment. The contro-

versy ended with the Navy specifying such a standard tube, which de Forest either could not or would not make, and so he lost what might have been a very profitable business during World War I. It was appreciated by those in charge that Dr. de Forest had brought audions into the world and to the Navy Department, and that it would have been only right to reward him in the form of orders; but Navy efficiency of course came first.

### Audion Amplifiers

All of the foregoing refers to the use of the audion as a detector for reception of spark signals. Next in line was de Forest's offer of the audion as an amplifier, destined to become an indispensable element in radio operation. For years previous, various forms of amplifiers, all of the carbon-microphone type, had been tested by the Navy. Not one had proved worth adopting. On November 25, 1912, all this was changed. On this date de Forest sent to the Navy for test a "breadboard" model of a three-stage audion amplifier, the result of his experimentation at the laboratory of the Federal Telegraph Company, Palo Alto, Calif. This was brought to the Arlington station, NAA, by Charles Logwood, Dr de Forest's assistant, and others. Chiefs W. A. Eaton and J. W. Scanlon, and the author, tested it for distance, and also for degree of amplification. Stations hitherto unheard at NAA, especially some on the West Coast, came in readably, even in the daytime. Technical measurements showed an amplification of 4 for the first stage (in terms of "audibility") and a value of 10 for two stages. The third stage "squealed" so that it could not be used. This model, although crude, showed so much promise that de Forest was encouraged to develop it into practical form, and during the ensuing years many purchases were made. In December, 1913, the Radio Telegraph and Telephone Company, one of de Forest's companies, quoted \$475 for an amplifier, and that same month a requisition was made by the Navy for ten amplifiers with four relays and bells and two loud-speaking horns. (The relays were of the Weston galvanometer type, and the bells showed that de Forest had at last caught up with Slaby's coherer and bell of 1903!)

The third development of de Forest which came into later major adoption by the U. S. Navy was his oscillating audion, particularly when associated with a receiver and used for heterodyne reception. The history of this is indeed involved.

The Navy first became interested

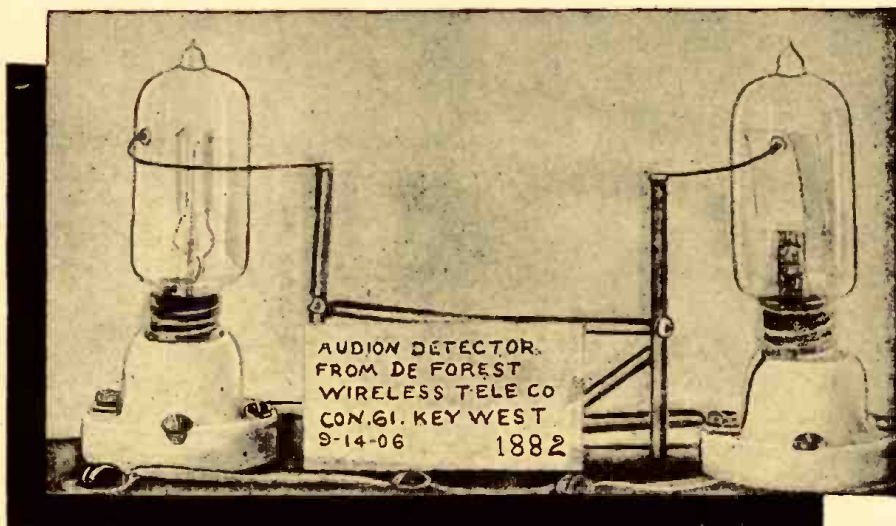

Courtesy Clark Historical Library

Two of the early pre-grid de Forest audions, each with two plates and filament.



in heterodyne reception during 1912, when the 100-kw Fessenden spark set at Arlington and a 30-kw Poulsen arc temporarily installed at the same station by C. F. Elwell were being given a long-distance test by reception on the U.S.S. *Salem*. The spark set, of course, developed discontinuous waves; the arc was a continuous-wave generator. The Fessenden company installed on the ship the first heterodyne receiving system known to the Navy. It was used to compare the distant spark and arc sets.

### The Oscillating Detector

Up to that time the arc had been copied by means of a rotary *ticker*, a fine wire pressing on a rotating drum. Such signals were rustling, "shushy." Spark signals, however, when received on an electrolytic or crystal detector, gave a clear, musical sound, especially when the sending station was powered by a 500-cycle alternator, as was the case at NAA. But with the heterodyne method of reception, all was reversed; the spark signals lost their musical nature, while those from the arc became musical indeed, and with the added advantage that the note could be varied at will by the receiving operator to suit his own ear. To this may be added the fact that the heterodyne signals from the 30-kw arc were heard much farther than any signals from the giant 100-kw spark.

But all was not perfect, despite these advantages. Heterodyning was performed, on the *Salem*, by mixing the incoming signals with continuous waves produced by a local oscillator. This latter was a small arc, though not so very small, at that! Moreover, the arc was highly temperamental, and worked only when it wanted to, as the writer well remembers. With the Navy's insistence on dependability and uninterrupted communication, such a device was not usable, even though desirable. What, then, could be substituted for the arc as a generator of c.w.?

As of course everyone knows today, the answer was "an oscillating audion." But, due to reasons which will not be discussed here, no one had at that time brought such a device to the Bureau for test. The writer had heard of such a means, through records shown to him by a company then making tests at Arlington, and he at once made his own tests. He used home-wound feed-back coils, and even went so far as to coin a name for these: "tickler coils"—because they "tickled the audion and made it oscillate." But since no commercial form seemed to be available

for such use, the Navy's work was experimental only.

In April, 1914, the de Forest company wrote to the Navy, stating that it was about to display a new form of receiver at an exhibition sponsored by the Bureau of Standards, and asking that a representative of the Navy Department be present. "This includes the use of the audion as a detector of undamped oscillations," the letter said. This was enough to cause immediate and thorough inspection, and it was found that these receivers fitted exactly the Navy's desire for c.w. reception. It was also said that these receivers "did not include feed-back coils, hence did not violate existing patents." A number of sets were at once purchased from de Forest, and these so-called "Ultraudion" receivers—in which, it was learned later, feedback action did exist, though in a form of capacity coupling—made it possible for the Navy to make fullest use of its arc transmitters, and in a short time to provide a world-wide chain of radio communication.

Had some other company brought to the Navy's attention a coil-coupled form of feedback, the writer can say that as far as he was concerned he would certainly have tested it and recommended its adoption; but no one did. That de Forest, who was already recognized as the father of the audion and of the amplifier, should now have brought a third feature of the little tube into play, by using it as an oscillator and thereby making heterodyne reception practicable, seemed but another logical development of this versatile inventor.

### Audion Transmitting Tubes

But there was yet another offering which he had to make to the U. S. Navy and to the world. That was the

development of the tiny receiving tubes into larger and larger ones, generators of electric waves which in time became the source of high-frequency power for all forms of transmitters. De Forest sold sets of this nature to the Government, particularly for airplane use, but the flood of business arising from the war led to the advent of many other manufacturers, and de Forest by no means reaped a rich reward for what was later proven to have been legally his offspring.

Of the later work of de Forest in pioneer broadcasting, of his untiring efforts along other lines such as motion pictures, television, diathermy, and the like, this article does not treat. His invention of grid control of the vacuum tube was the tiny forerunner of a new era of radio communication, replacing other too ponderous types of continuous-wave production by smaller, more controllable devices, in the form of small and large vacuum tubes. He was first to produce a successful type of amplifier, long the goal of inventors. His success in setting up persistent oscillations by means of the vacuum tube made the heterodyne reception of radio telegraphy possible, and later these tubes, enlarged, supplied the other end of the chain by becoming the creative part of the distant transmitters themselves. On the basis of successful achievement alone, Dr. "Aladdin" de Forest, as he should have been called, deserves a world's praise in these electronic days, and he in turn undoubtedly will admit that much of his success in those earlier years was due to the pressure of the needs of the United States Navy.

The foregoing represents the author's memories of his personal experiences, and is not intended to refer in any way to the possible viewpoint of any other person or organization.

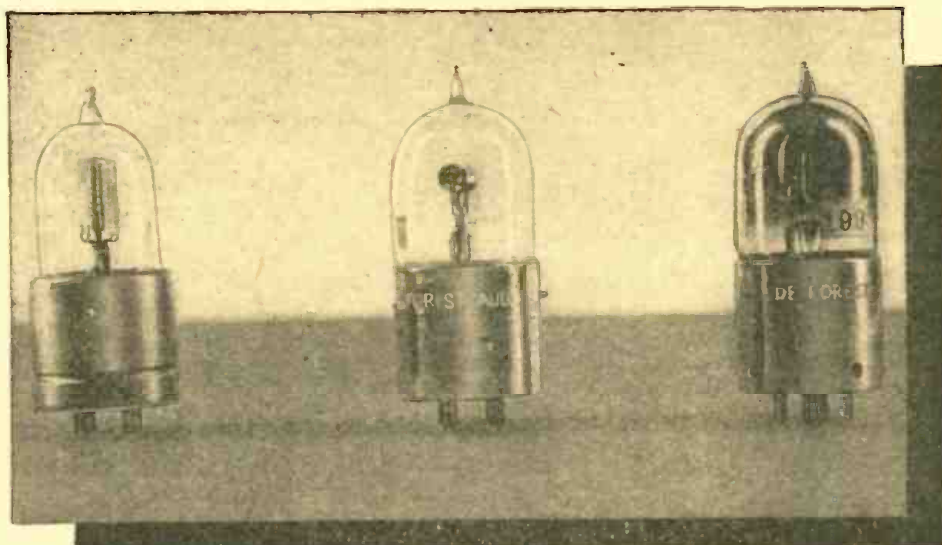

Two Type 20's and one VT-21, a tube used by the Government during the first World War.

Courtesy Gerald F. J. Tync



# AN EARLY RADIOPHONE



THE MODERN reader has difficulty in fully appreciating the impact of some of de Forest's earlier discoveries on the technical world of the time. So obvious are their effects today that it is difficult indeed to realize that they were by no means so to the wireless authorities of the 1900's.

Readers can get a fair idea of how the radiophone was looked upon in those days from the following article, reproduced verbatim from MODERN ELECTRICALS, August, 1908:

The new art of wireless telephony has advanced to such a stage that the U. S. Navy has lately equipped 32 war vessels with complete sets. This point alone is a guarantee of the practicability of the wireless telephone, as it is a well known fact that the government does not adopt any apparatus until its utility has been proven.

The sets were sold under a contract to hold unbroken communication up to a distance of five miles regardless of fogs or atmospheric disturbances. This distance, however, has been doubled several times, and the latest records

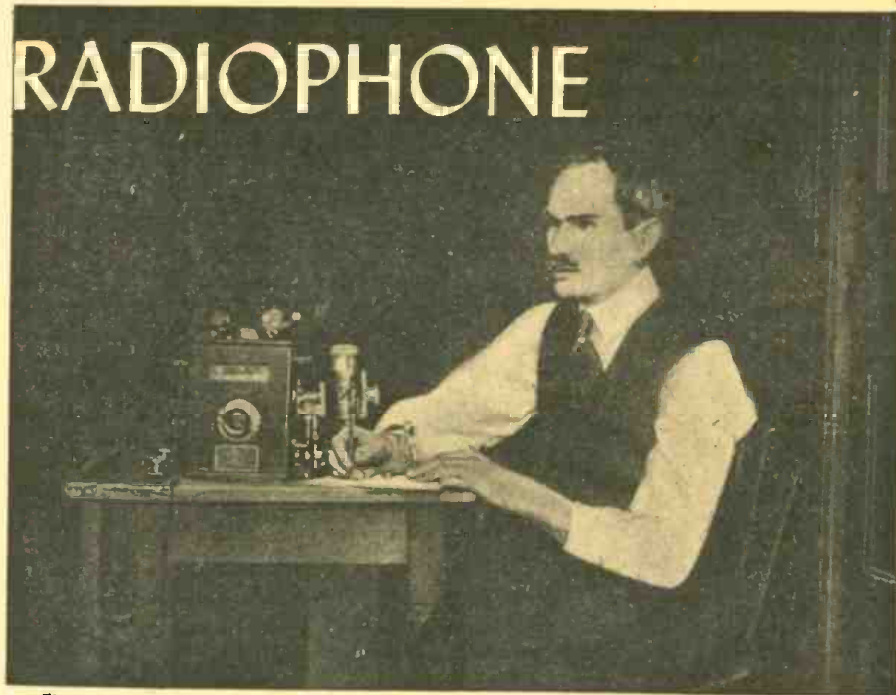

Fig. 2—A photograph of de Forest at one of the instruments described in this article.

show that a distance of 26 miles has been covered, the messages being picked up by the receiving end of a wireless telegraph set which no doubt could have been farther extended by the use of the special telephone receiving sets as employed with the telephone.

The fleet which sailed around the Horn to the Pacific was equipped with complete sets. Admiral Evans could keep in constant communication with any of the ships—directing the movements of the whole fleet from one point

which may sound the death knell of the old wig-wag system of signaling used for an indefinite period by the navy.

The naval attachés are particularly proud of the fact that the U. S. navy is the only one in the world utilizing this means of communication but already foreign ambassadors are negotiating with the makers for like sets.

In operation the wireless telephone is very simple, and depends on the same principle as telegraphy, that is, the generation of Hertzian waves that pass through space 186,000 miles per second. While the principle is the same, yet the actual working is vastly different,

as was soon realized by the numerous investigators who took up the subject with the introduction of wireless telegraphy. In telegraphy the transformer or transforming device is supplied by alternating current with periodic break or direct current with mechanical break. In either case the emitted wave is periodic. This, however, would not answer for wireless telephony, as the break would destroy all properties of speech.

The problem now was to provide some means for generation of a continuous wave current and impress thereon the modulations of the human voice which would possess the same qualities when caught at the distant receiving end and reproduce the spoken words.

The generation of such waves was made possible by the use of Duddell's arrangement, which is identical with the wireless telephone of the day with the addition of a few changes.

The circuits of the de Forest sending and receiving ends as shown in the May issue are repeated here for sake of clearness.

The transmitting set consists of an ordinary arc lamp (oscillator) burned in the flame of an alcohol lamp from a 220-volt circuit, which sets up oscillations. The latter flow through the condenser and primary of transformer, exciting the secondary, which has one terminal leading to the ground through a telephone transmitter, and aerial wire.

It can now be understood that the wave current in flowing through the transmitter to the ground and aerial wire will be changed to the same proportion as the voice which falls against the diaphragm of the transmitter. A certain portion of this wave is caught by the antenna of the receiving end, which flows through the primary of a transformer set to the same wave length; passing the secondary, it flows

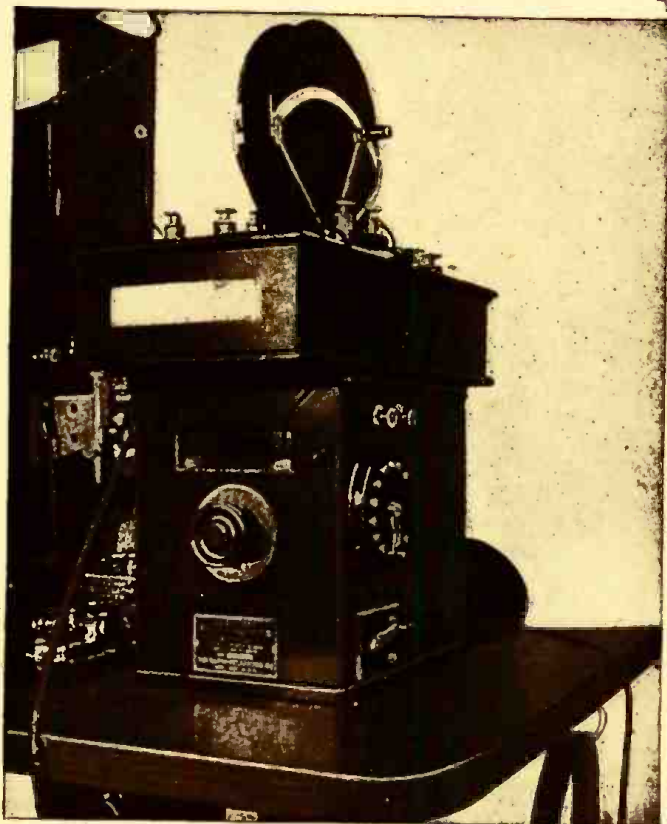

Fig. 4—Close-up of receiving apparatus and tuning equipment.



through the capacity condensers to the "Audion"; here it produces a like change in the ionized gases which changes the current from a local battery flowing through a telephone receiver, resulting in the spoken words increased in sound to a large extent.

Here we have the complete de Forest system, which of course required a considerable amount of ingenuity and work on the part of Dr. de Forest to bring the apparatus to its present stage of perfection.

In the June issue of this magazine was described a "Flame Audion" which works on the same theory as the one employed in wireless telephony. The "Audion" used by de Forest is an ordinary incandescent lamp with a platinum grid and wing sealed in a lamp bulb, as shown in the diagram. The "Flame Audion" has the platinum contacts inserted in the flame impregnated with certain salts.

In Fig. 3 is shown a set designed for portable use, and is packed ready for transportation. [It was not possible to reproduce this figure.—*Editor*].

With this set communication can be established in a short while, as portable and easily handled aerial arrangements are being provided for this purpose.

To the left is the transmitter, consisting of the high tension coil placed in case with telephone transmitter mounted on an arc lamp in the back. The telegraph key and a device known as the "chopper," which resembles the ordinary buzzer, are shown in the front. The "chopper" is inserted in the aerial wire, and when the key is pressed operates the wireless telegraph apparatus, for calling, etc.

The complete receiving set is shown in Fig. 4. Here we have the "pancake" syntonizer on top, adjustable condenser, tuning arrangement, and reserve "audion" for use in emergency.

In Fig. 2 is shown Dr. de Forest at the instrument, the audion is seen between his hands.

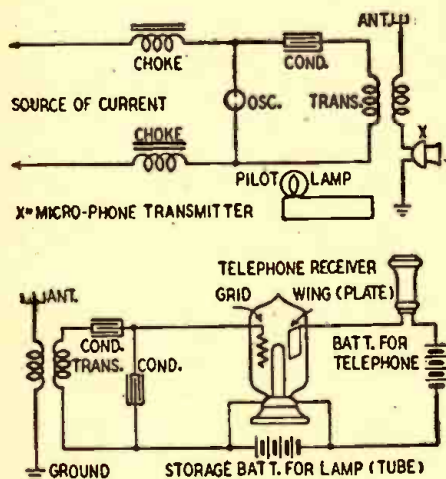

Fig. 1—Transmitter and receiver schematics. These were typical of early de Forest equipment. Oscillator symbol represents a carbon arc in its pot. The telephone receiver shows strong influences from the 75-ohm line type, indeed often used with radios of that period.

# FIRST RADIO ASSOCIATION

## By Hugo Gernsback

SOME TIME during the early fall of 1908, when wireless was booming, the writer became convinced that it was necessary to band together the wireless amateurs into a national body. Accordingly, he set out to launch an association. The chief reason at that time was to organize a national body to ward off adverse legislation against the wireless amateur.

In those heydays there was no radio law. Anyone who had a transmitter just helped himself to whatever wavelength he took a fancy. Obviously, such a condition could not continue for long, and

association. Late in October, 1908, Dr. de Forest accepted. The other founders, all well-known radio personages, were John S. Stone of radio fame, who became Vice President; William Maver, Jr., author of one of the first radio engineering books, was Secretary; the writer was Chairman and Business Manager.

The league finally was organized in November, 1908. The first announcement of the new body "The Wireless Association of America" appeared in the writer's publication MODERN ELECTRICS, in the January, 1909, issue,

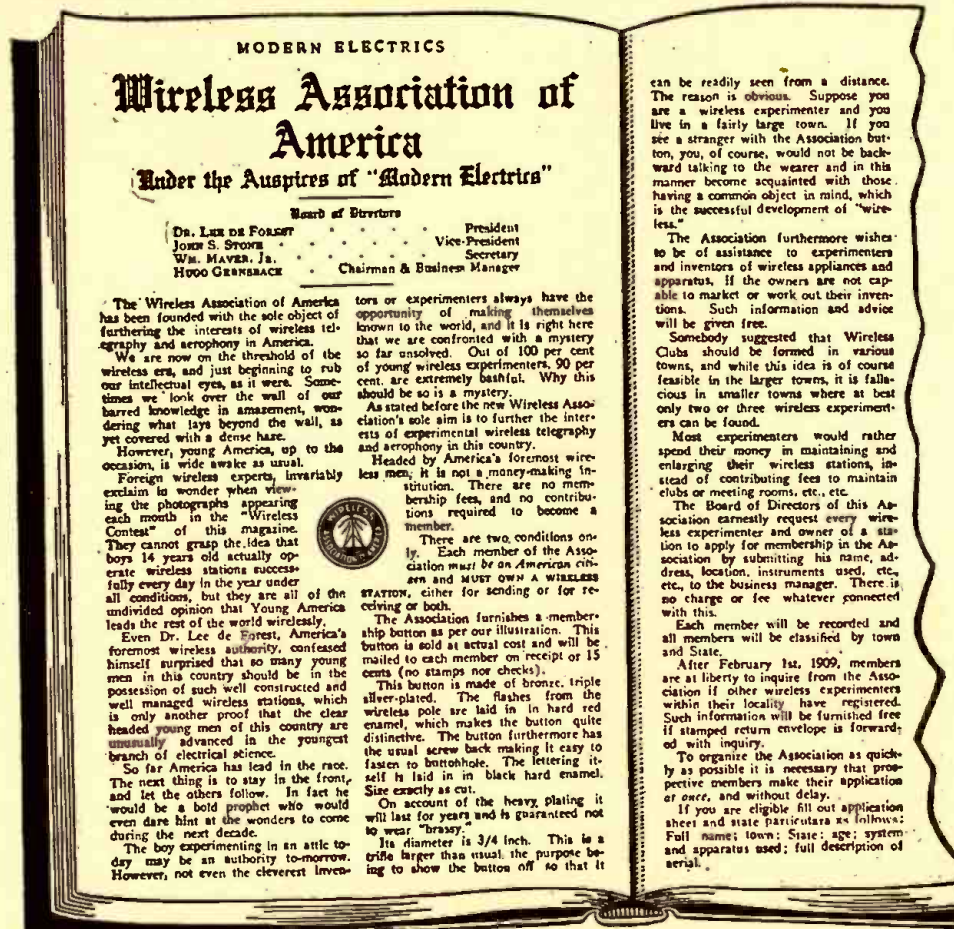

The above is a reproduction from the January, 1909, issue of MODERN ELECTRICS. Illustration in the center is the first radio association insignia: a lapel button of that time.

already there were rumbles that Congress intended to do something about it.

Everyone feared that the amateur might be put off the air entirely. It was the writer's thought that if a national body of amateurs existed, they could make their voice felt in Washington, which indeed they did when the first radio law was enacted in 1912.

To give the proposed association a solid standing the writer, in October, 1908, wrote a number of letters to well known radio personalities. Even in these early days Dr. Lee de Forest was easily the outstanding radio figure in this country. For that reason the writer proposed to de Forest to become the first president of the first national wireless

which was on the newsstands in December, 1908. This was the first national radio association anywhere in the world.

By the end of 1912, the Association had some 14,000 members scattered all over the country and each member was given a lapel button to wear.

The Association also printed a book with the names and addresses of the members. Its title was: *The Wireless Bluebook*; it also was the first radio association membership book in print.

It is significant that Dr. Lee de Forest, who has so many firsts attached to his name should also have been the first President of the first Wireless Association.

(Continued on page 40)



# FIRST PHONE BROADCAST

By Frank E. Butler



THE INVENTION of the three-element vacuum tube by Dr. Lee de Forest in 1906-7 met with foggy and apathetic recognition instead of being welcomed with open arms and appre-

ciated by the electrical industry and the government.

The U. S. Navy Department flatly rejected the first audion tube receiver as being impractical and unreliable. A storage battery, officials said, was subject to constant recharge with subsequent possibility of losing part of an incoming message; battery fluid might spill during action at sea, thus ruining

Forest's idle dreams of a new wireless world—and all this happened 12 years before the Radio Corporation of America was thought of.

In a word there was no place nor persons to turn to for counsel, encouragement, or assistance.

De Forest, far from discouraged, loomed up at the lab with a changed mental attitude, fresh for another round, and indicated that the fight was not over. His first suggestion was to chuck the wireless receiver under the table. He was through with it for awhile. He announced that his new idea was to develop a wireless telephone, and explained that this thought had

These were located above or within the hot alcohol flame, in a chimney area about 1½-inches in diameter. The chimney was open at the top and the strong, obnoxious odors emanating from the lamp were almost unbearable.

It should be borne in mind that the audion first was produced as a reception device. At the time of the wireless telephone tests de Forest was unaware of the oscillating qualities of the tube and its capacity to act as a transmitter.

Finally all was in readiness for the initial test of talking across the room. A discarded shipping box salvaged from a rug concern on a lower floor provided the workbench upon which rested our hopes, represented by a breadboard hookup of a jumbled mess of tubular cardboard boxes mounted with wires, an upright standard or rod holding a Blake carbon-button telephone transmitter, an alcohol lamp with chimney, and other apparatus. On the opposite side of the room the one and only audion receiver, "Old Grand-dad"—which had been retrieved from underneath the table—rested majestically on the drafting board, the only piece of real furniture in the lab. The distance of this historic test was less than ten feet.

Dr. de Forest, coatless and in a serious mood, stood before the transmitter, breathing the foul fumes of burnt alcohol, carefully changing from one adjustment to the other as he spoke into the microphone, drawling monotonously: "One, two, three, four—Can you hear me?"

On the other side of the room, with headphone pressed tightly to my ear I listened, as I too changed tuning adjustments. In my uncovered ear I could easily hear de Forest's voice, but the headphone on the other ear was unresponsive. Just then a connecting wire broke from its hurriedly twisted, joint and fell at de Forest's feet. Stooping to pick it up, his face accidentally touched the metal frame of the telephone transmitter. He jerked away and exclaimed:

"That's hot! No wonder the thing won't work. Now, I know what's wrong—those granules in that carbon button are packed together. The phone circuit is shorted!"

He picked up a screwdriver and as he resumed his singsong monologue, he struck the metal frame with the handle, saying:

"One, two"—*bang!* The blow instantly dislodged the carbon impaction and permitted the word "three" to go through his jumble of wires and leap the intervening gap of space between

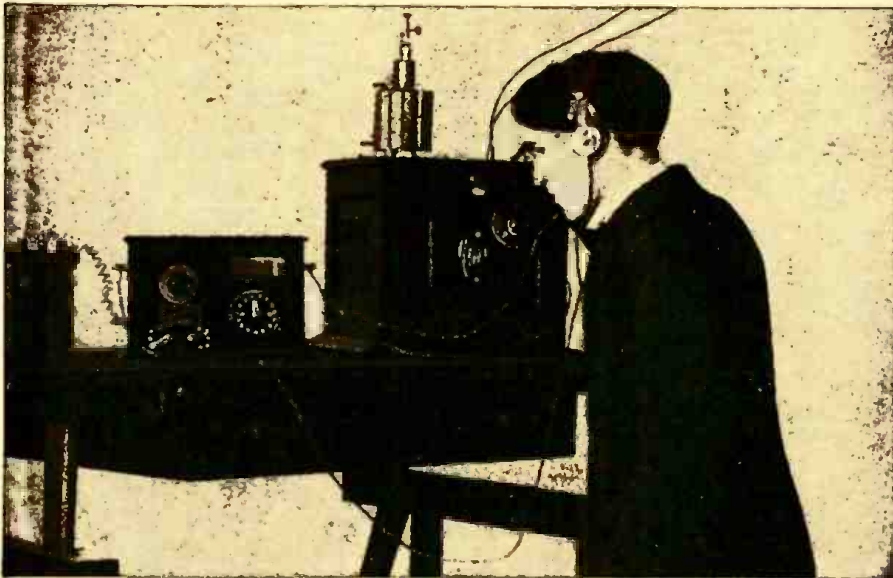

The author, Frank Butler, stands in front of the equipment which made the first broadcast.

the deck of the operator's cabin. Besides, it was too high in initial price and the renewal cost of bulbs, compared to the low cost and reliability of detectors then in use.

The Western Union and Postal Telegraph Companies, likewise the Bell Telephone System, frowned upon the idea. Long distance telephony, though greatly desired, was then unborn because mechanical relays were insufficient for the assigned task of boosting. Western Electric was concerned only in making instruments for the telephone company. George Westinghouse was interested in manufacturing airbrakes for railroad trains; Thomas Edison and the Victor Talking Machine Company in turning out phonographs. The General Electric Company specialized in motors, dynamos, and other small electrical parts. None of them were professionally interested in de-

been in his mind for some time while he was busy with other matters.

Fortunately, the Parker Building in New York City, had both 110 and 220 volts d.c. It was this latter voltage de Forest chose for experiment with a "singing arc." Among his first tests he found that the standard wireless telegraph transmission circuit was not adaptable to the arc principle, therefore the entire circuit had to be revamped and tested before it could function as a generator of the continuous, undamped, high-frequency waves which were required. Many experiments were conducted to determine the correct method of surrounding the arc with a gaseous atmosphere and the proper kinds of electrodes to employ. An alcohol lamp was decided upon to supply the required gas from denatured fumes within a chimney made of thin fire-clay through which two electrodes extended.



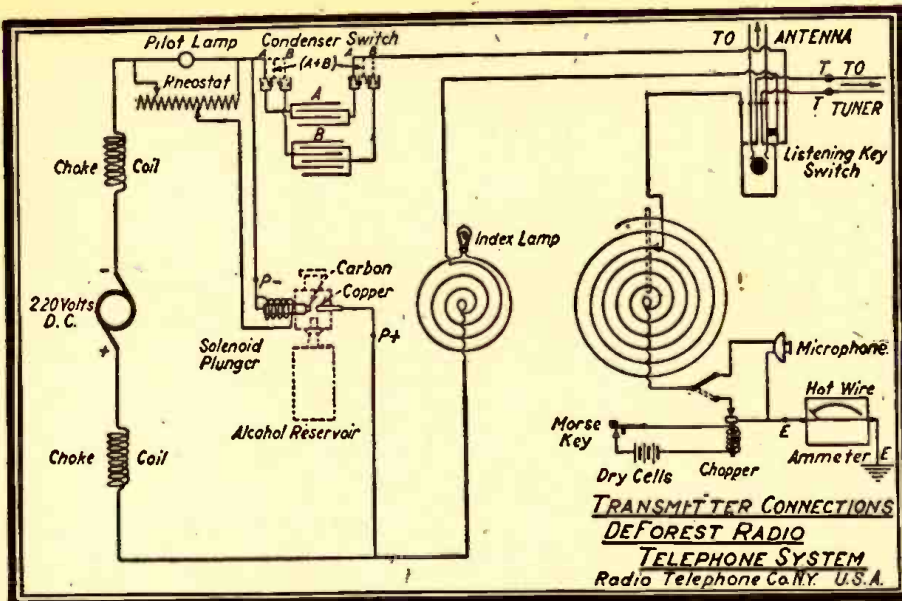

Schematic of de Forest radiophone, the commercial version of the original transmitter.

us, the "three" being clearly audible in the headphone on my left ear.

Space conquered by wireless telephony!

At that moment, in the early summer of 1907, radio broadcasting was born!

In the dazzling light of current achievements it is far more difficult to recapture the immediate simplicity and importance of this occasion than to rhapsodize on its measureless portents. Commonplace ideas today—worldwide radio communication, talking pictures, radio, and electronics—all were unborn. The problem then was to transmit the voice only a matter of inches.

"Let's rig up an antenna from that 30-foot flagpole on the roof and send this stuff out over the air," said de Forest. "Guess we'd better try it with music, though. We'll save our words and let any listener guess who's doing it."

I was sent out to find a second-hand talking machine and returned shortly with a used phonograph and a single record—one side of which was "The Anvil Chorus" from *Il Trovatore*.

The Brooklyn Navy Yard was about four miles away. Just inside its Sands Street entrance stood a 150-foot pole, surmounted by a crossarm from which hung a dozen aerial wires leading into a one-room wireless shack at its base. This shack housed the Yard's first wireless telegraph station, which was equipped with a Slaby-Arco outfit of German design.

At the time this wireless telephone test was being made by Dr. de Forest, three Navy operators were on duty at this station—G. S. Davis, George F. Smith, and Arthur F. Wallis. Young Davis was on watch at that historic moment. With headphones on his ears he was vainly trying to intercept and copy a wireless message from a ship at sea. The signals were coming in very faintly. Nervously he fidgeted about as he sat on the edge of his chair, leaning forward and straining to hear the scarcely audible signals which were badly chewed up by rifts of uncontrol-

lable static. The other two stood nearby, unable to give any assistance. Finally, with patience exhausted, Davis exclaimed:

"I wish there'd be something else on the air besides that damned static—!"

His wish was granted sooner than he expected, for at that moment the whispering, spasmodic dots and dashes were unceremoniously interrupted by mysterious sounds that were unmistakably those of a "blacksmith hammering blows on his anvil with a sledge." Davis turned pale. He thought for a wild moment that his receiver was haunted, he later explained. Before he could utter a word, strains of music followed—a continuing portion of "The Anvil Chorus" record now being reproduced by de Forest in the Parker Building.

Disbelieving his senses, Davis was both scared and dumbfounded. No wireless operator had ever before heard musical sounds come through headphones. Frantically he called to his companions:

"Hey, fellers! Listen! Come here quick! Music, yeah, music—plain! Come quick—it's angels I guess."

"Aw you're nutty, Davis," exclaimed Wallis. "Here, gimme those phones." He snatched the headpiece from Davis's head. "Let me listen to whatever you're talking about!"

"God! You're right!" exclaimed Wallis, his tone of ridicule changing to one of amazement as he listened intently. "I never heard of anything like that before. Of course it's music—but it can't be angels, because how'd they be playing the 'Anvil Chorus' in Heaven, and that's surely what that music is. Here Smith—you listen! What do you think?"

Smith had been impatiently standing by, anxiously awaiting the chance to hear. He adjusted the phones to his ears just in time to hear the last few notes of music, and then a man's voice broke in and said:

"One" — boom — "Two" — boom — "Three" — boom — "Four" — boom — as de Forest wielded the screwdriver against the Blake transmitter between words to dislodge its granules of fused carbon. Smith, startled because he mistook the thumping "booms" for something else, took off the headphones and said to Davis and Wallis excitedly:

"I heard something too, but it wasn't angels singing or blacksmith's pounding. What I heard was gunfire. It sounded like an admiral's salute, only there weren't that many shots. All I heard was four. I know—I heard a man count 'em just before each shot."

The three operators, impressed with the uncanniness of hearing mysterious

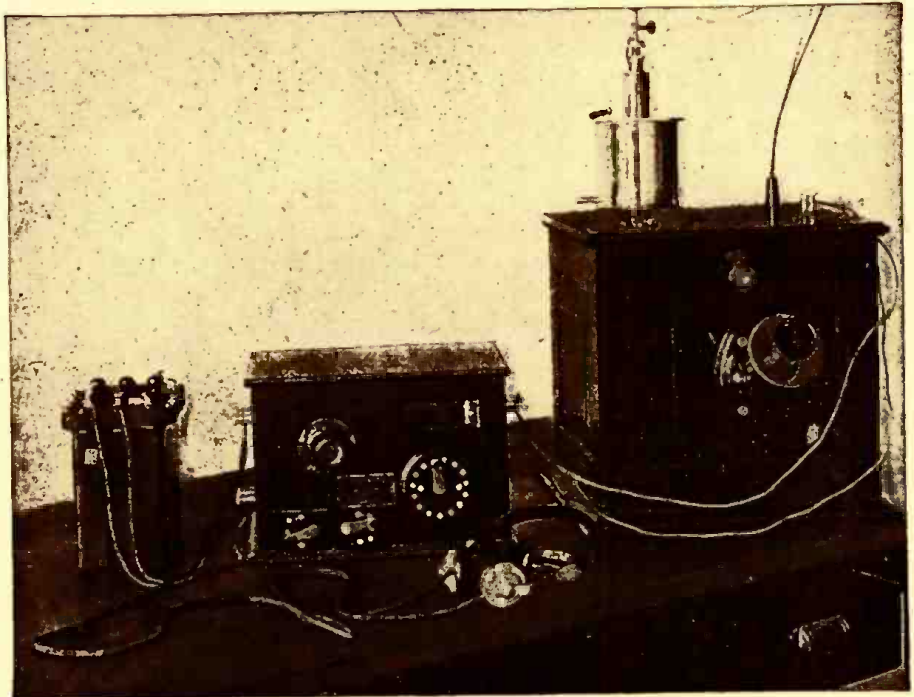

Early de Forest radiophone equipment, type B arc transmitter and audion receiver. Courtesy Clark Historical Library



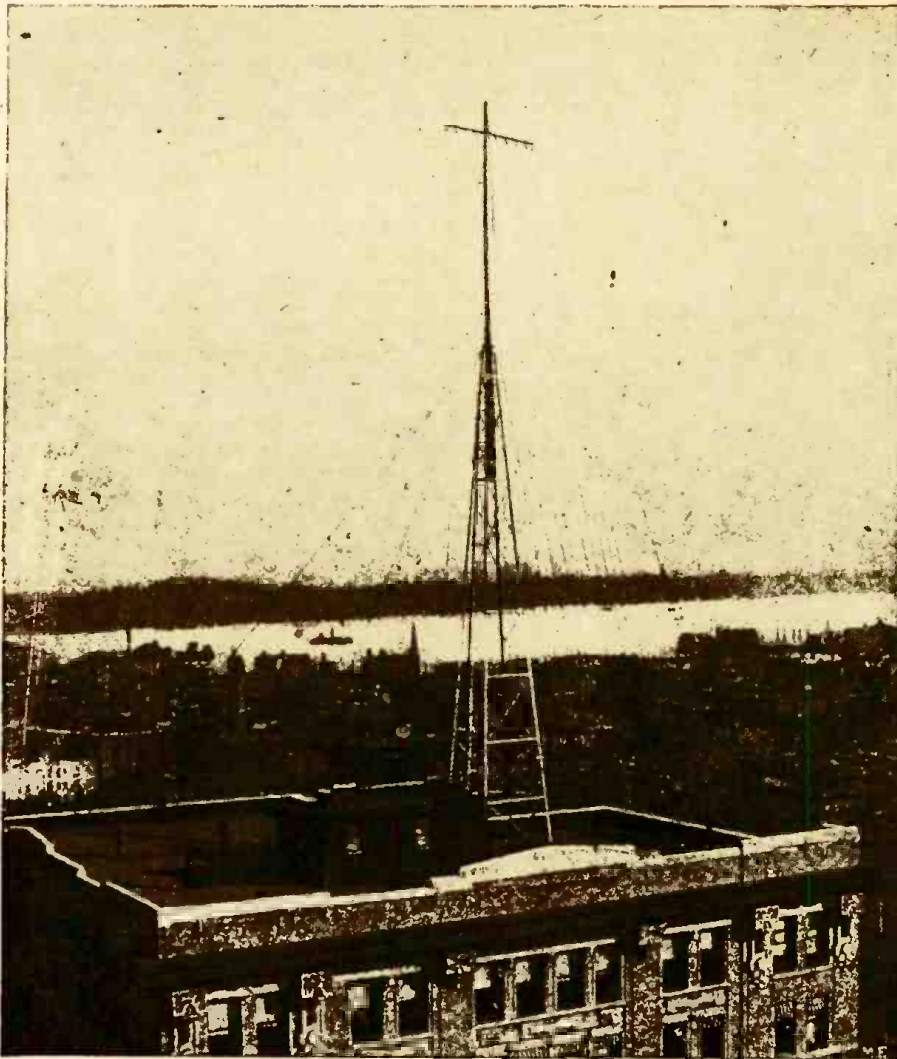

Photo reproduced from MODERN ELECTRICS, Oct. 1908 issue.  
 This "Aerophone Tower" was erected by de Forest's Radio Telephone Co. in 1908, on the Terminal Building, 42nd Street and Park Avenue, New York City. Intended for use in telephone communication with ships, it was 125 feet high and supported an antenna of eight phosphor-bronze wires, which ran from the top of the mast down to the edge of the building's roof.

music and voices coming through space by wireless, telephoned to New York newspapers and told of their experience. Stories were published around which reporters wove mystery as to through whom, where, and how such a new kind of wireless had come into being. As a result of this publicity the *Literary Digest* wanted a special story of the invention. A reporter and photographer called for particulars. De Forest gave them the details and they prepared to take a photograph of all the apparatus, including the original audion and its seven-plate Witherbee storage battery as well as the recently assembled wireless telephone transmitter which was now encased in a mahogany cabinet on top of which was the alcohol lamp. At the moment when all was in readiness for the camera shot I came in the door, just as the reporter said:

"I think if one of you men stood in front of these instruments it would be more appropriate and descriptive of what it is."

"Go ahead, Frank," said de Forest promptly, "You stand up in front of them—you've got your coat on."

Doubtless he did not realize at the time the tremendous historic importance that photograph would one day assume, else he instead would justly and rightfully have stepped up in my place even though he was coatless. As it was, that picture — herewith reproduced — appeared in the June 15, 1907, issue of the *Literary Digest*. A few months afterward a disastrous fire destroyed the Parker Building, completely consuming all of de Forest's possessions, including his priceless records, and all the original audions and wireless telephone apparatus. Thus this picture represents the only physical evidence in existence of that basic equipment from whence grew radio broadcasting and all forms of electronic speech.

## FIRST RADIO ASSOCIATION

(Continued from page 37)

More important than this is the fact that the Father of Radio clearly saw the great future of radio, even at that early date, and was willing to lend his name to radio amateurism then. Dr. de Forest proved himself a most staunch friend of the amateur, because it was he also who, in those pioneering days, set aside many of his Audions which were sold to the wireless amateurs.

The following description of the *Wireless Association of America* was written by radio historian Clinton de Soto, in his book *Two Hundred Meters and Down, the Story of Amateur Radio*, published by the A.R.R.L.

"The *Wireless Association of America* was a child of Hugo Gernsback, publisher of MODERN ELECTRICS. After the first few months of its existence, Gernsback announced a membership totalling 3200. By November, 1910, he claimed that this number had jumped to 10,000.

It was easy to recruit members for such an organization; there were no dues and no obligations. Youthful electrical experimenters signed up in swarms, attracted by the famous names in the honorary membership group and the ease of becoming a member. The membership represented a fairly accurate index of national interest in radio, although not, of course, of the number of active transmitters. Even so, the number of worthwhile amateur stations on the air had, according to conservative observers, increased from perhaps one hundred and fifty in 1905 to five or six hundred. The number of small spark coils in use was several times that figure.

"In early 1910 the first *Wireless Blue Book* of the Association appeared dated 1909. It listed ninety U.S. amateur stations who were members of the Association together with the call letters used, approximate wavelength in meters, and

the spark length of the induction coil. Stations were listed in the following states: Massachusetts, New York, New Jersey, North Carolina, Missouri, California, Texas, Rhode Island, Oregon, Illinois, Ohio, Pennsylvania, Connecticut, Florida, Indiana, West Virginia, Montana, Washington, Minnesota, Wisconsin and Maine. Wavelengths ranged from 32 to 950 meters. The average spark gaps were from ½ to 3 inches. Two stations had the exceptional length of 10 and 14 inches, respectively.

"The second *Blue Book* appeared June 1, 1910. Meanwhile the number of copies of MODERN ELECTRICS printed had increased from the initial 2000 to 30,000. The *Wireless Association of America* continued to send out more and more gaudy membership certificates, and the cumulative numbers on the membership rolls mounted higher and higher."



# Radio Inventions of Lee de Forest

By Fred Shunaman



THE FAME of de Forest as the inventor of radio's most fundamental component has obscured his important work in the radio field as a whole.

Many well-informed persons are not aware that he was the inventor of the transformer-operated spark transmitter, the quenched gap used on many shipboard installations till 1940, and the metal radio tube. A few more know that he holds the original patent on regeneration and that he was the inventor of the grid leak. His 1903 patents on r.f. transmission lines cover practices not fully put into use till two or three years ago. Dozens of other patents cover useful improvements in the radio art, or point the way to further progress in radio invention.

De Forest's radio patents date back at least as far as 1902, when he was working on an early type of detector he called a *responder*. Opposite in action to the coherer, it consisted of two metal plugs sealed in a glass tube with a "suitable" solution between them. It was connected in a local battery circuit, as well as to the antenna system. "Little trees and branches" of metal were built up between the two plugs by electrolytic action, bridging the gap and reducing the resistance of the circuit. A signal on the antenna broke down these little bridges, raising the resistance of the circuit.

De Forest called his detector an anti-coherer, and abandoned it only to work with the long series of "heat detectors" which culminated in the audion.

## Transmission Lines

Startlingly modern are the antenna feed-line systems described in Patent No. 730,246, filed March 8, 1902, and granted June 9, 1903. Fig. 1-a shows a quarter-wave vertical antenna A and ground G, with a parallel-wire feed-line, BB' running to the responder or detector R. Bridges CC connect the lines to-

gether at half-wave intervals, to short out signals of unwanted frequencies. The broken line D indicates the voltage wave along the line and signs indicate the polarity. Fig. 1-b is a co-axial cable version of the same system. Twisted pair is shown in Fig 1-c. Standing waves were expected on the twisted pair, and bridges C are shown. MM are choke coils and Q a telephone. A local battery N is used with the Responder.

The year 1902 saw de Forest busy on other important inventions. Among these was a metal-oxide detector, Patent No. 770,228. Two steel needles, C in Fig. 2, are held by a spring against two aluminum pins, DD. Means for adjusting the spring tension is provided, and the effect of the oxide coating on the aluminum is specifically mentioned, though it is stated that other metals may be used.

Two important patent applications were filed in June, 1903. One of these was the transformer-operated spark transmitter (Patent No. 749,435), shown in Fig. 3. Induction coils with their vibrators and low-voltage contact points were troublesome and tended to set a ceiling on transmitter power. As shown in Fig. 3, a gas-engine-driven alternator G supplied

current to a low-voltage 1-to-1-ratio transformer T. A key C was placed between this transformer and high-voltage transformer T1. Choke coils K prevented r.f. surges from backing into the low-frequency lines. The oscillating circuit consisted of gap S, capacitors L, and antenna and ground A and E.

This invention made the spark transmitter a reliable and powerful instrument, and induction coils disappeared except in low-powered experimental apparatus.

The second invention of June,

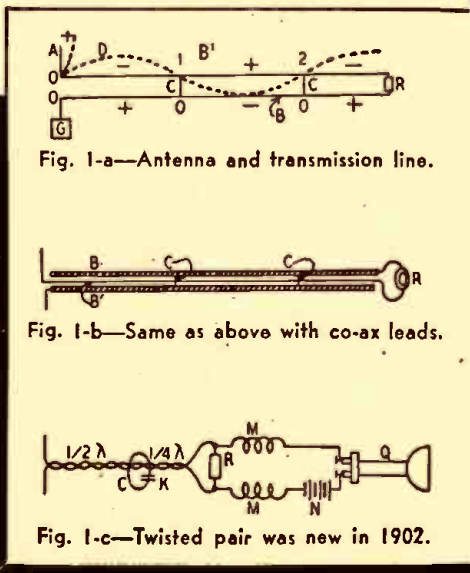

Fig. 1-a—Antenna and transmission line.

Fig. 1-b—Same as above with co-ax leads.

Fig. 1-c—Twisted pair was new in 1902.

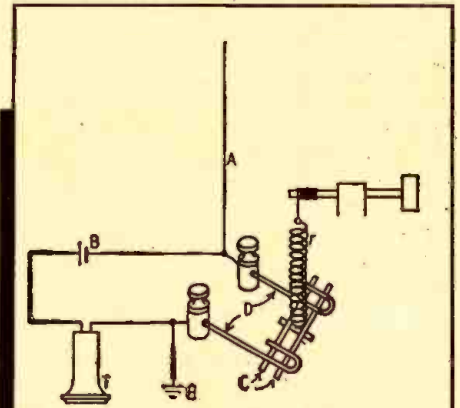

Fig. 2—Early metal-oxide radio detector.

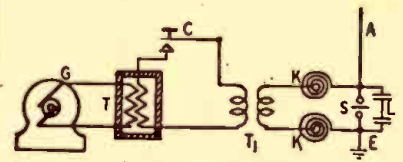

Fig. 3—Alternating-current transmitter.

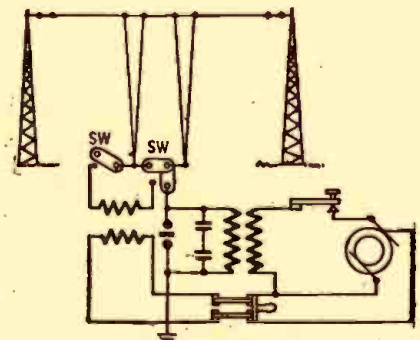

Fig. 4—Device for ice-freeing antennas.



1903, was a device for clearing ice from antennas, Patent No. 750,181. As shown in Fig. 4, this was a method of passing a high current at low voltage through part of the antenna, thereby heating it and melting off the ice. Switches connect either the transmitter or the ice-melting equipment to the antenna, paralleling the lead-ins to the spark gap and separating them across the low-voltage transformer secondary.

### Simultaneous Operation

Break-in operation of wireless stations was another of de Forest's June, 1903, patents (No. 749,434). Two aerials were to be used, connected to two motor-driven commutators on the same shaft. Transmitter and receiver were thus alternately connected to their aerials. The patent suggests that the commutator rate at each station be different, with one interrupting at 40 times per second and the other at 60 (for example), so that the two cannot drift accidentally into synchronism, with both transmitters and both receivers on the air at the same time.

A more modern break-in system is covered in Patents No. 827,523 and 827,524, issued in 1906. A contact on

the end of the telegraph key disables the receiver during transmission. The detector is shorted in one form, and in another the anode of the then-popular electrolytic detector is lifted out of the liquid with which it is normally in contact. This patent shows gaps between the receiver and ground, to short heavy static charges to earth.

An anti-static antenna system is proposed in Patent No. 759,216, application for which was filed May 14, 1902. Two antennas were connected to a single detector in such a way that one would neutralize or "buck" the other. One antenna is tuned to the frequency of the desired signal, the other left untuned. Atmospheric discharges, which would affect both antennas equally, were expected to balance out and produce no response in the detector circuit. The desired signal would produce a much stronger signal in the tuned circuit than in the untuned one, and therefore would be detected.

Patent No. 894,378, applied for in 1903, shows a two-antenna system used for a different purpose. Signals were transmitted simultaneously on two frequencies. Receivers on each frequency were so adjusted that the combined signal from the two an-

tennas would be just strong enough to operate the detector. The system was expected to reduce interference, but there is no reason to believe that a very strong signal on one of the tuned frequencies would not upset the system.

### Radiocompass Patents

An early direction finder is described in Patent No. 771,818 (applied for May, 1904). De Forest had already pointed out in his 1902 patent on transmission lines that a two-plate antenna would be directional, since radiation would be at a minimum in a direction edge-on to the plates (Fig. 5-a). The 1904 patent includes a flat plate (A in Fig. 5-b) on pivots C, an electrolytic detector D, battery B, and telephone T. With the plate turned broadside to a signal, reception would be at a maximum. Edgewise on, signal pickup would be at a minimum. A light wire frame of vertical wires could be substituted for the metal plate, which was 6 x 15 feet in size in the inventor's experiments.

A later patent (No. 771,819) shows what looks like a directional dipole, AA' of Fig. 5-c. Being "short as compared with one-quarter wavelength of the received waves" however, it received its strongest signals when end-on to the transmitting station. The same patent describes what is practically a loop antenna (Fig. 5-d). A single wire (inverted-L antenna) pointed away from the distant transmitting station is also claimed to be directional. In a much later patent, No. 1,101,533, the inverted-L directional principle is fully worked out. Several antennas radiate from the station. Switches connect to the equipment the antenna pointing in the direction opposite to that of desired transmission or reception.

### The Aerophone

De Forest's first radiotelephony patent (No. 973,644) was applied for in 1906. Called an *aerophone*, it was described as "a wireless telephone in which a resistance device is varied by . . . air vibrations accompanying speech and other sounds." In its simplest form (Fig. 6) it consists of an arc K' between antenna and earth, a generator G, and an oscillating circuit, coil P, condenser C, and arc K'. The microphone K is inductively coupled to the oscillating circuit by transformer T. Its winding P forms part of the oscillating circuit and the microphone is connected across winding S. In another form of the invention, the microphone is connected directly across the arc, through choke coils, and the oscilla-

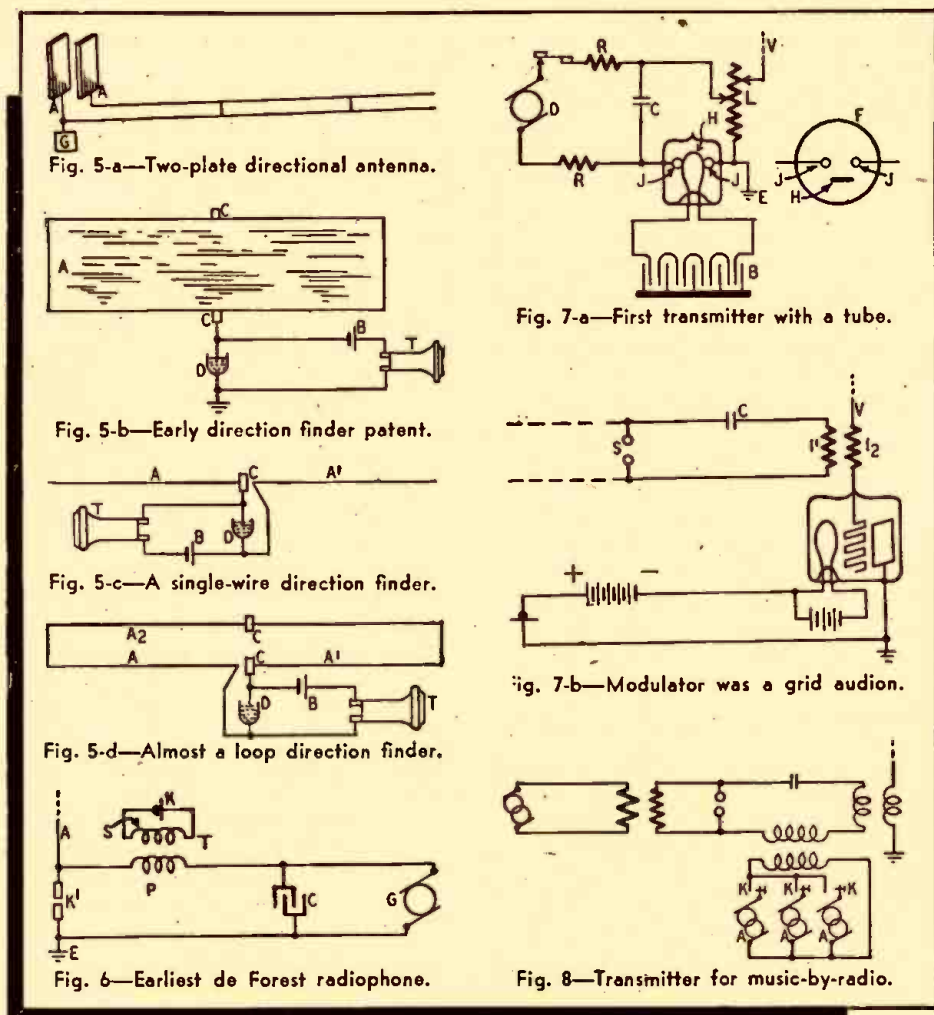



tor and antenna circuits are tuned.

A number of patents (Nos. 850,917, 913,718, and 995,339) describe improved arc circuits. Patent No. 926,937 shows two arcs connected in parallel to the same antenna. Patent No. 926,936 is an arc transmitter modulated by a low-power spark gap placed either in the d.c. or the oscillating circuit. Other modulated-arc circuits are shown in Patent No. 913,718.

### The Grid Audion

The modern vacuum tube first appeared as part of a radiophone circuit in 1907. Application for the fundamental patent on the grid audion was filed on the 29th of January. On the same day an application was made for a patent on a space telegraph or telephone using that tube, as well as earlier types of audions. Patent No. 943,969 (Fig. 7-a) describes a transmitter which uses a two-plate audion as a discharge tube instead of an arc. Apparently the tube acted as a relaxation oscillator. D is a generator, K a key, RR resistors, C a condenser, L an inductor, and V and E the antenna and earth. The audion contains two plates J and a heater H, supplied with current from battery B. Fig. 7-b has an arc S, an oscillation transformer I1 and I2, and a three-element audion in the antenna circuit as modulator. The extremely naive hookup shows how little was then known of the audion.

An *oscillating resistor* was described in Patent No. 979,277. This was a conductor with a negative temperature coefficient, and was installed in place of the arc in an oscillating circuit. The description of this device is somewhat reminiscent of the "talking ceramic" heralded a year or so ago.

### Music By Radio

Another 1907 invention, on which the patent (No. 1,025,908) was not granted till 1912, proposed to transmit music by wireless and described an electrical musical instrument. Fig. 8 shows the circuit, a conventional arc transmitter. It is modulated by low-powered alternators A, which supply current at frequencies corresponding to notes in the musical scale. Three of these modulators appear in the figure. Keys K may be manipulated like those of a piano keyboard or an organ manual. De Forest's interest in radio musical devices continued. A circuit with an audion oscillator was invented in 1915 (Patent No. 1,543,900).

Later he invented the *Pianorad*, an instrument with a multiplicity of tubes and speakers.

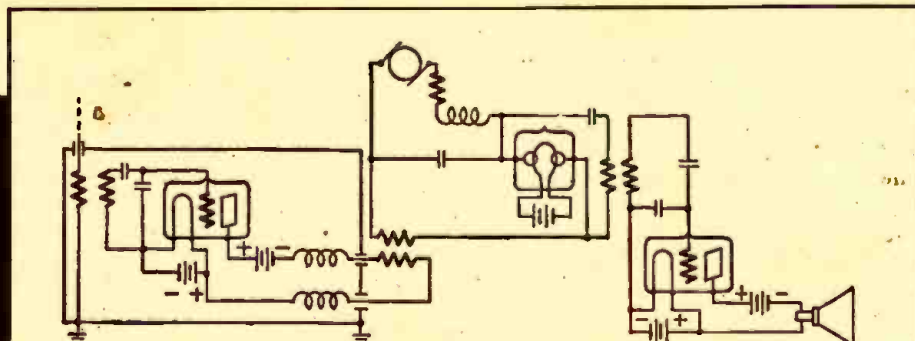

Fig. 9—This 1907 three-tube heterodyne receiver had the first stage shielded.

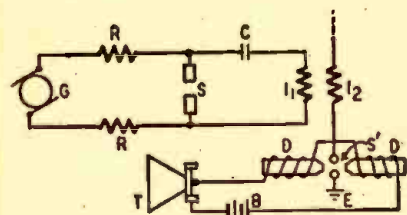

Fig. 10—A magnetic modulator circuit.



Fig. 11—Section of quenched spark gap.

A receiver-amplifier invented in 1907 contains many modern features. Covered by Patent No. 995,126 (issued in 1911) it consisted of two grid audions and a discharge tube, which supplied local oscillations (Fig. 9). The first stage, mounted in a metal box, is possibly the first shielded receiver. The output, according to the patent, modulated the continuous oscillations from the two-plate discharge tube (relaxation oscillator). The modulated output was further modulated by a third tube, in the plate circuit of which a telephone was connected.

A magnetic modulation system was another of the inventions of the prolific year 1907. A form in which the magnet coils DD are placed across the gap of a secondary arc in the antenna circuit is shown in Fig. 10. T is the microphone. The other letters indicate the same parts as in other figures. Patent 1,006,635, issued in 1911, covers the invention. Several other patents on systems with magnetic modulators were taken out by de Forest.

Patent No. 1,171,598 (Fig. 11), application for which was made in 1910, covers the quenched gap, with the specially shaped plates and the fiber washers used till spark was outlawed in 1940.

The regenerative receiver is described in Patent No. 1,170,881, for which the application was filed

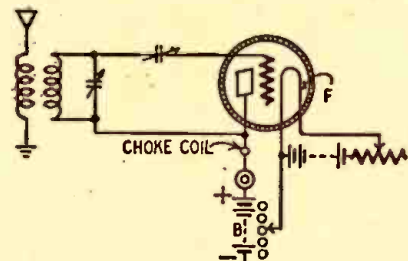

Fig. 12—The first regenerative circuit.

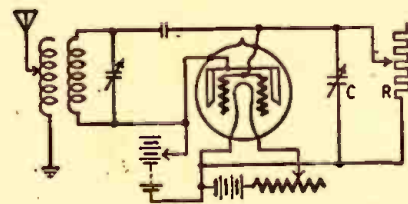

Fig. 13—Audion receiver with grid leak.

March 12, 1914. As shown in its simplest form in Fig. 12, it could be published today as a simple one-tube ultraaudion circuit for the beginner, though it is doubtful if modern tubes would work without the grid leak.

Increased selectivity as well as sensitivity is claimed in the patent. "If the potential in the circuit of battery B and the current in the circuit of filament F are so relatively adjusted that the grid circuit is just ready to be set into oscillation, we find that said circuit is highly responsive to received impulses the group frequency of which is that at which the circuit tends to oscillate, but not sensitive to group frequencies materially differing from the natural period of the grid circuit," says de Forest in describing the action of his "Ultraudion." Use of the detector in an oscillating state was specified, and a drawing of the same circuit as a radio-frequency amplifier appears in the same patent.

The oscillating grid audion is referred to casually in No. 1,170,881, but it was not until September 1914, that an application was made for a patent on an oscillating audion as a transmitter. This patent, No. 1,201,270, is especially interesting because it covers the *grid leak*. "A high and preferably noninductive resistance" between the grid and filament, says de Forest, increases the energy of the oscillations generated enormous-



ly. "For example, from the order of a microwatt to that of tens or hundreds of watts. I have discovered that a still further increase in oscillation energy is obtained if a small capacity is connected in parallel to the resistance." The circuit appears in Fig. 13, complete with resistor R and capacitor C, which actually is a throttle condenser controlling feedback.

### Special Tube Types

Metal tubes were patented by de Forest in 1916 and 1917. The earlier patent, No. 1,201,271, proposed a double-walled tube, with a layer of "a suitable liquid, such as mercury" between the walls to overcome the porosity of metals to gases. Patent 1,230,874 shows a single-walled tube, the envelope of which is used as the anode. Metal tubes, the patents stated, could stand rough handling in shipment and use, and would permit greater power outputs than glass tubes.

A multiple-grid tube, with each grid performing its own specialized function, was described in Patent No. 1,311,264, applied for September 4, 1915. It had two inner grids, two outer grids, and two plates. See Fig. 14. Each pair of elements is connected in parallel, and in a modern schematic would be shown as a single element. The inner grid, or grids, is part of the ultraudion oscillating circuit. The outer pair is in the microphone circuit. The present system of suppressor modulation is approximately the same as this one.

Another circuit (Fig. 15) described in the same patent, has a pair of intermeshing coplanar grids reminiscent of those in the Wunderlich tube. The secondary of the microphone transformer is not center-tapped, however, and the supposed action is not quite clear. A number

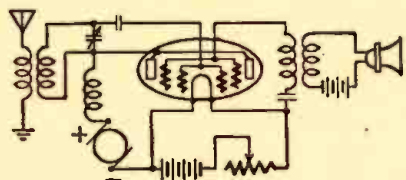

Fig. 14—Multiple-grid tube transmitter.

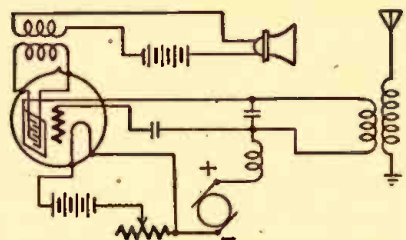

Fig. 15—Variation of the above circuit.

## A POEM BY DR. DE FOREST

Although de Forest has written poems at intervals ever since his college days, the poetic side of his many-faceted character has always been overshadowed by his scientific accomplishments. The following poem indicates that he might have succeeded as poet if he had not decided to become an inventor.

### California Twilight

I love a pine tree outlined on the night,  
Behind it spread a drapery of light,  
The moonbeam's weaving witchery's delight,  
Mysterious, mysterious!

I love the glimmer of a mountain stream  
When twilight's glow has faded to a dream  
In pools where stars descending seem  
Pendulous, pendulous!

I love the shadows of the spectral hill  
Across the canyon when the night is chill,  
And silence seals the river singing still,  
Melodious, melodious!

—LEE DE FOREST

of other interesting circuits are shown in the patent.

Finally, the artistic side of de Forest's nature comes to light in a patent (1,720,544), issued in 1929. It "has for its object the provision of a radio receiving apparatus which is

tuning devices strangely like the modern "butterfly" are a few of the other ideas he brought forth. Radio components also received much attention from him. His work on loudspeakers is described elsewhere in this issue.

After 1920, de Forest turned more and more to talking pictures and television, turning out a steady flow of inventions even to the present day. Indeed, he reported to the convention of the Television Broadcasters' Association, October, 1946: "I am carrying on a few experiments in connection with television inventions, which I expect to finish . . . within the next two or three years."

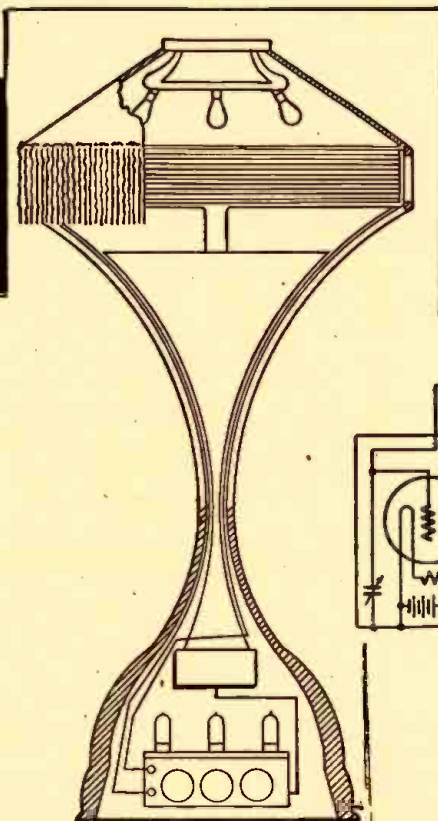
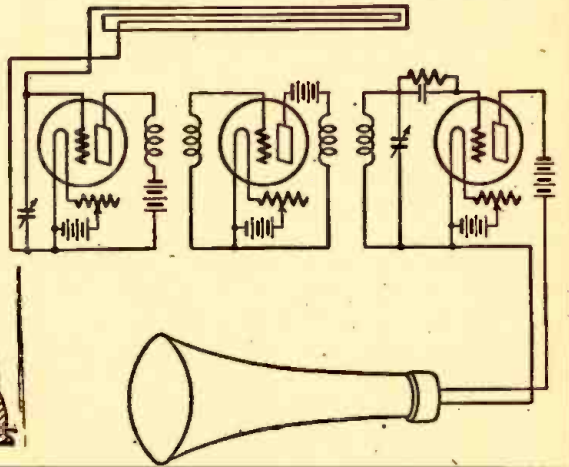

Fig. 16—An ornamental receiver is the object of this table-lamp-radio patent.



or may be at the same time ornamental," and is nothing less than a radio table lamp (Fig. 16). The standard houses the speaker, and the tuning inductance (actually a loop) is wound round the lower part of the lampshade.

Only a small fraction of de Forest's 200 or more patents can be described in this story of some of his lesser known contributions to the improvement of communication between human beings.

Improved spark transmitters, secrecy devices, special antenna-counterpoise systems,



# E. I. Co. Sold First Audions

By Hugo Gernsback



W AY back in 1907, when Dr. Lee de Forest was experimenting with his first three-element audion, the Electro Importing Company, which had been started by the writer in 1904, was going full blast, supplying wireless apparatus and instruments to early experimenters and amateurs.

The first catalogs of the E.I.Co.—in their wireless sections—dealt principally with coherers. It was not until the year 1906 that the writer brought out the *Auto-Coherer*, which was illustrated on page 25 of the Electro Importing Company's Catalog No. 3.

Previous to that we had been selling the coherer and decoherer instrument, but as it could not receive signals over distances of more than a few miles, the *Auto-Coherer* was brought out. This *Auto-Coherer* was sold for many years by the E.I.Co. It was used in connection with a telephone receiver, rheostat and battery and brought in signals over fair distances.

It was not until 1908 in its Catalog No. 5 that the E.I.Co. featured its first crystal detector, in which carbon, molybdenum, or silicon could be used.

In the same catalog was also featured an electrolytic detector which was invented by the writer. The original electrolytic type of detector had been invented by Dr. Fessenden, but it required a battery for its operation. I eliminated the battery by making a primary battery out of the detector itself. I used a carbon cup which held the acid; then the fine Wollaston wire became the other element of the battery. Thus was combined, for the first time, a battery and a detector all in a simple instrument.

Thus things stood until the year 1911 when we brought out E.I.Co. Catalog No. 10, in which was featured for the first time de Forest's audion. Wireless had now arrived in earnest!

The E.I.Co. when it announced the audion on page 93b of Catalog No. 10, made history in that it was the first time that Lee de Forest's audion was sold commercially to the public. The page showing the historic advertisement of the audion is reproduced here.

For several years the audion was advertised in E.I.Co. catalogs and in *MODERN ELECTRICS*, the writer's former magazine—the first radio magazine in print up to that time.

What I did not know until recent years, however, was the fact that the Electro Importing Company not only sold the first audion to the public, that is, to radio experimenters and ama-

one of Dr. de Forest's patent suits.

It appears that the following firms were users of audions. First, of course, de Forest himself and his various companies. It should be noted that the de Forest concerns did not sell audions in the years between 1909 and the end of 1913, but used them in various wireless telegraph and telephone sets which they sold *complete*.

98b

**THE "ELECTRO" AUDION.**

After long deliberation, we herewith present the best audion manufactured to-day in the United States. Of all the detectors in use, none present the accumulation of advantages offered by the Audion, the "Electro" model being designed from the result of long and extended experiments. While the crystal types of detector present many advantages, they have the one great defect of not holding their adjustment, especially on receiving from a nearby station. The Audion, not only ranks as the highest in sensitiveness, but possesses that much sought for characteristic, stability of adjustment. Loud signals do not affect the adjustment, and, on the contrary, seem to improve the sensitiveness. When receiving from loud or nearby stations, the light will be noticed to flicker in the bulb, and the signals can thus be read without the use of a telephone receiver, this feature being found in no other detector. Signals received by the Audion are extremely loud, and most stations in the vicinity of the receiving station may be heard with the phones three feet or more from the operator's ears.

The "Electro" Audion, consists of a vacuum bulb containing two filaments of tantalum, connected in series with a lead taken off at the connecting point of both filaments. One filament is used at a time, and at the exhausting of one filament, the other may be resorted to. This gives double the life which is obtainable from other audions. The filaments are used on 4 volts, which may be obtained from storage battery or dry cells. The bulb also contains a wire which is bent in a zig-zag form, and called the "grid." A small sheet of nickel foil is also contained in the bulb. It is behind the grid and the metal foil. Under normal conditions, the current from a 30-35 volt battery connected with a telephone receiver has great difficulty in passing through the heated vacuum space. However, on reception of the wave trains, the current from the battery passes through the vacuum and produces an audible sound in the receiver. The audion is the most suited detector for wireless telephony, owing to its faithful reproduction of every wave. The 30-35 volts required for the telephone receiver circuit, may be obtained from 6 to 7 flash light batteries. Inasmuch as the current used is practically zero, a set of these cells will last for a long time. The apparatus is connected as shown in the diagram. In this instance a loose-coupler is shown, giving the set the maximum degree of selectivity. The rotary rheostat is also used, our No. 5000, which is very suitable for this purpose in regulating the filament current. The flash lamp dry cells are also shown connected in series with the telephone receiver. Here it might be stated that the audion will give excellent results on low voltage telephone receivers, though, of course, the better the receivers the further the range.

Full instructions given with each instrument. Size of base, 5 1/4 in. x 3 1/2 in. Height, 3 1/2 in. Weight, 1/4 lb.

No. 8200. The "Electro" Audion as described and illustrated..... \$4.00  
By mail extra, shipped in heavy wooden box ..... 0.25



**8200**

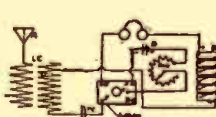

The first Audion advertisement appeared in Catalog 10 of the E.I.Co., New York, 1911.

teurs, but that is also sold by far the largest quantity of audions between the years 1911-1913, of any company in the world. The following figures, which were taken from records of the McCandless Incandescent Lamp Company, makers of the first audions, are most interesting. They were used in

As far as is known none of these sets were sold direct to the public, but to services such as the Navy, etc.

The Electro Importing Company marketed its first audion in June, 1911. During that year the company (Continued on page 49)



# DE FOREST THE INVENTOR



By H. Winfield Secor



OME of the most interesting patents granted to Dr. Lee de Forest were not in the field of radio. These less well-known inventions cover such diverse fields, as

diathermy, talking pictures, photo-electric devices, range finders, television apparatus and airplane instruments.

## Cautery Device

One of the early de Forest medical patents disclosed an idea for a high frequency cautery device. Patent No. 874,178 was issued on it Dec. 17, 1907. An oscillating or singing arc R (Fig. 1) was the exciter for the cautery electrode. A tuned circuit comprising a condenser C and an inductance I<sub>1</sub> is shunted across the arc A; this inductance may be the primary coil of the air-core transformer used to transfer the high-frequency current to the cautery electrode E. E' is the ground electrode. Frequencies of 500 to 1,000 kc are suggested.

Dr. de Forest has experimented considerably in the shortwave diathermy field. His patent No. 2,126,541 provides a unique design for such apparatus. The output or treatment electrodes are excited by vacuum-tube oscillators 0-0 in a circuit tunable from 3 to 13 meters.

A coiled Lecher wire system L is used; this gives the advantages of the distributed capacity and inductance of the Lecher system and at the same time greatly reduces the dimensions of the apparatus. See Fig. 2.

## Tube-less Amplifier

A tube-less amplifier of the dynamic type is the unusual device covered in patent No. 1,134,594, dated Apr. 6, 1915. A series of magnetic windings A, B, C, on iron cores are placed in close proximity to a revolving metal disc, similar to the arrangement in a homopolar dynamo. (See Fig. 3.) The signals to be amplified are passed through the several coil windings in progressive order, and as the inventor states, "there is thus provided a means of dynamically amplifying minute current impulses, imparting thereto new energy from a local source . . . without moving contacts, microphonic or otherwise . . . and without ohmic resistance or resistance-altering devices." A unique invention, to say the least, and worth study by all electrical and radio students.

## Telegraphone

Magnetic wire recorders engaged the attention of de Forest at an early date.

Two patents involving the use of such devices are No. 1,375,447, Apr. 19, 1921 and No. 1,177,848, Apr. 4, 1916. The first patent describes means for reproducing sounds from magnetic sound records (steel wire recorders). The second covers the procedure for magnetically recording the amplified pulsating current thus produced. The originating wire recorder A may have its steel wire magnetized by sound waves (electric voice currents) in the usual manner. This device permits one to make a duplicate copy B of a telegraphone record. See Fig. 4.

## Subterranean Signalling System

Transmitting and receiving high frequency signals through the earth is proposed in patent No. 1,424,805 (Aug. 8, 1922). The transmitter and receiver are connected to earth through buried metal plates separated quite a distance. The earthed circuit is preferably tuned to the generator frequency by suitable tuning means. Advantage claimed is the freedom from atmospheric disturbances.

## Pneumatic Telephone

The transmission and reception of speech or other sounds, such as tele-

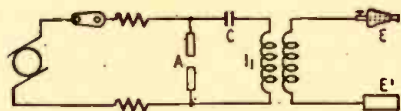

Fig. 1—A high-frequency surgery patent.

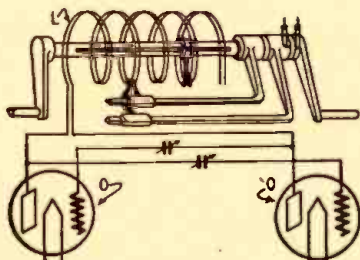

Fig. 2—A special circuit for diathermy.

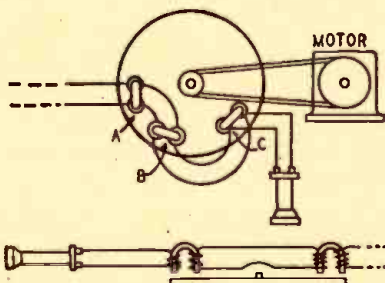

Fig. 3—Dynamic amplifier without tubes.

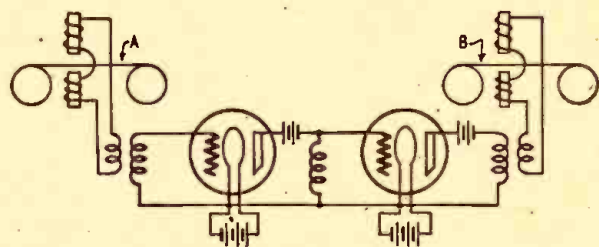

Fig. 4—Means for reproducing magnetic-wire sound records.

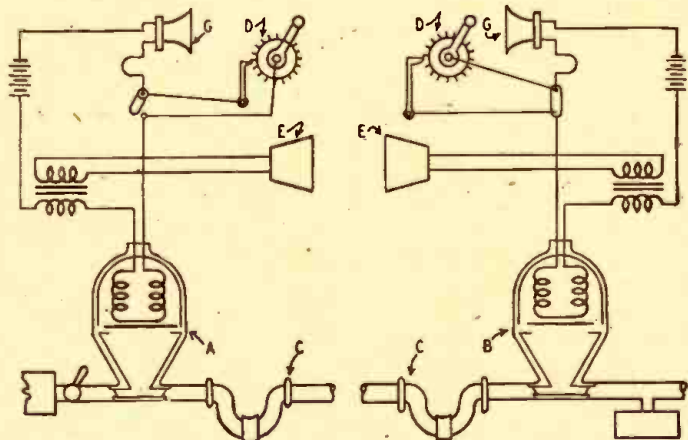

Fig. 5—A pneumatic telephone for communication on trains.



graph signals, over the air-brake pipe line extending along a train of standard railroad cars, is described in patent No. 1,515,152, Nov. 11, 1924. See Fig. 5. Magnetically controlled air pulsators (A and B) are used to impress the sound vibrations upon the air column in the pipe line C (the air brake and signal lines).

Stations are called by means of interrupters D (noise producers). When the engineer or conductor hears a buzz-saw note in the receiver, he knows that he should listen for a message.

The sound waves induced in the air line are picked up by the magnetic pulsators, the vibrating air column causing a diaphragm to vibrate and in turn induce electric currents of corresponding frequency in coils placed behind the diaphragm. These voice currents may be amplified, and are connected to a standard type telephone receiver E or loudspeaker. Microphones are marked G.

### Thermionic Phono Pickup

Electric pickups for phonographs have become very popular in recent years. De Forest received an interesting patent—No. 1,554,561—date Sept. 22, 1925—for a phono pickup operating on the thermionic principle. The sound vibrations picked up by the needle A in contact with the phonograph record are transmitted to a grid member B sealed into an evacuated glass chamber, as shown in Fig. 6. A heated filament within the tube supplies an ionized field; vibrations of the grid cause corresponding modulation of the current in the circuit connected to the electrodes of the tube. The output of the thermionic pickup may be connected to a vacuum tube amplifier and any desired amplification of the sound readily obtained.

The pickup is strongly reminiscent of the *Vibrotron*, a 1946 tube based on much the same principles.

### Diffraction Microphone

A novel diffraction microphone invented by de Forest Aug. 27, 1929, is described in patent No. 1,726,289. In this device a beam of light is flashed onto a photocell. A polished mirror A is interposed in the path of the beam of light; this mirror is electrically heated. (See Fig. 7). It was found that sound waves striking the heated layers of air in proximity to the mirror caused changes in their diffracting powers and consequent variations or diffraction in the beam of light. In turn these variations in the beam of light are recorded by the photocell B, connected in a telephone or modulator circuit; the pulsations in the voice are thus reproduced in the circuit controlled by the photocell.

### Gaseous Microphone

A noise-free microphone of the gaseous type forms the subject of patent No. 1,834,051—dated Dec. 1, 1931. The microphone is built into a glass and metal cylinder A, fitted with a flexible gas-tight diaphragm D at one end. See Fig. 8. An electrically heated cathode C

is mounted a short distance behind the flexible metal diaphragm. Voice (air) waves striking the diaphragm cause variations in the ionized field between it and the heated cathode, causing fluctuations in the current in the main telephone circuit connected to the microphone. The chamber may be exhausted to a high degree and a slight amount of gas admitted.

### Loudspeakers

De Forest was much interested in loudspeakers.

A diaphragmless loudspeaker is described in patent No. 1,641,664—Sept. 6, 1927. As Fig. 9 shows, two spirally wound strips, insulated from each other, are connected to the output of an amplifier or other voice current supply. The cathode strip A is heated to provide an ionized field between the two spiral conductors. B is the anode; C is the heating current source. When this field is modulated by the voice current, the surrounding air has sound waves set up in it, in the manner of the speaking arc. The cathode spiral strip may be made of fine woven wire, loaded with certain oxides of the rare earths to intensify the electronic emission.

Other patents on loudspeakers include No. 1,560,502—a means of vibrating a curved loudspeaker member. The actuating device or motor for driving a loudspeaker is the subject of patent No. 1,718,337. A novel cone speaker is illustrated and described in patent No. 1,554,794. Another diaphragm-less type

speaker is described in patent No. 1,486,866. A sealed inflated elastic body has wires wound around its exterior surface, which causes it to contract and expand in accordance with the fluctuations of the voice current impressed on the microphone M. See Fig. 10.

A table-lamp speaker appears in patent No. 1,452,827—Apr. 24, 1923, and a cylinder type speaker in patent No. 1,736,035—Nov. 19, 1929.

A novel speaker mechanism designed for controlling the escape of compressed air in accordance with the undulations of the voice current applied to it, is described in patent No. 1,766,612—June 24, 1930. This speaker is intended for use where powerful sound waves are to be reproduced. The voice coil moves longitudinally in the field of a strong electromagnet, and causes slots in a valve to open and close in exact proportion to the fluctuating strength of the voice current. See Fig. 11.

Compressed air is admitted through pipe A which passes clear through the center core of the magnet. The magnet is excited by direct current. A brass dome B is threaded onto the upper end of the magnet core. This dome has slits C cut into it, through which compressed air from the tube A can pass, whenever the sliding sleeve D is moved up and down by the voice coil and uncovers the slits.

A corrugated diaphragm E supports the moving voice coil G and the valve sleeve. The compressed air liberated through the slits is in direct proportion

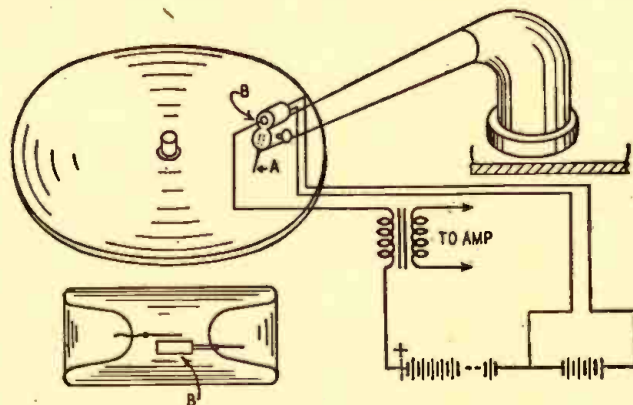

Fig. 6—This phonograph pickup works on the thermionic principle.



Fig. 7—A microphone which employs a vibrating mirror and photocell.

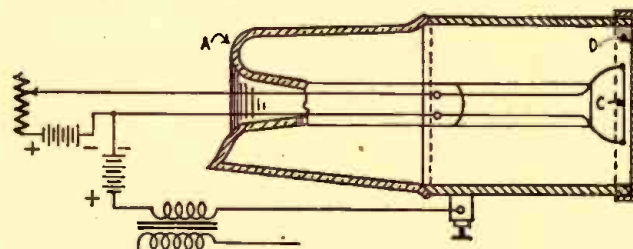

Fig. 8—A gaseous-tube microphone with vibrating anode-diaphragm.



to the strength of the varying voice current, thus creating powerful sound waves in the horn attached to the air-valve chamber.

A combination cone and horn speaker is described by de Forest in patent No. 1,785,377—Dec. 16, 1930. See Fig. 12. This combination has been found to reproduce the broad band of voice frequencies more satisfactorily than either speaker alone. Another similar type speaker of large proportions, for use where a great volume of sound is desired is covered by patent No. 1,853,850.

### Thermophone

A loudspeaker of the *diaphragm-less* type, operating on the hot-wire or ther-

mophone principle, was invented by de Forest Feb. 17, 1925. See his patent No. 1,526,778 and Fig. 13.

A fine wire W is concentrated in an insulating disc D (or at the focus of a parabolic reflector in one form), fitted with a perforated cover through which the sound emerges.

The heating effect of undulating voice currents causes the fine wire to expand and contract. These rapid thermal changes are communicated to the adjacent air envelope and set up sound waves therein.

One of the advantages of the thermal type speaker is the faithful reproduction of sound. The principle involved is worthy of further study by our engineers intent upon high-fidelity music and speech reproduction.

An unusual scientific principle is involved in a loudspeaker (or microphone) covered by patent No. 1,738,988. It utilizes variations in the capillary boundary between two liquids of differing densities. See Fig. 14.

With mercury and dilute acid, for example, placed in a capillary tube, a meniscus or semi-globular surface forms between them. If a varying (voice) current is applied to such a tube through suitable electrodes making contact with the acid A and the mercury,

B, the current will cause the contact surface or meniscus, C, between the two liquids to rise and fall within the tube. This action in turn will create sound waves in the acoustic horn chamber shown in the picture. This is the *loud-speaker* action.

When used as a *microphone* the reverse action occurs . . . the sound waves strike the liquids in the capillary tube and cause the meniscus to rise and fall. If an electric current is connected to the tube terminals, variations corresponding to the voice fluctuations in this current will be created (in the external circuit). A loudspeaker connected in this circuit will reproduce the sounds originating at the capillary microphone.

### Talking Pictures

Dr. de Forest performed a great deal of research on devices to improve the early talking pictures. An early patent, No. 1,482,119, Jan. 29, 1924—describes a method for recording the picture and the voice record on the same film simultaneously. An early arrangement used an arc for recording the voice patterns on the film. Some more stable form of glow discharge was desirable, and one of de Forest's designs for a glow tube that could be modulated by the voice current, is covered in patents No. 1,806,746, May 26, 1931, and No. 1,873,558, Aug. 23, 1932. See Figs. 15 and 16. The glow or corona A was concentrated at one end of the tube and was of high intensity. The voice current, when super-imposed on the electrodes B and C of the glow tube, caused the intensity to vary.

Binaural recording and reproduction of sound is interestingly described in patent No. 1,769,907 of July 1, 1930. This has to do with speakers placed in different parts of the theater, each speaker reproducing certain frequencies and thus giving a *third-dimension* sound effect.

### Photo-Electric Cell

An improved photocell was devised and patented by de Forest, July 30, 1929 (Patent No. 1,722,280). See Fig. 17. The light-sensitive cell A is made in a flattened *lenticular* shape so that the electrodes within the cell will be located only a short distance from the film B on which the sound track is impressed. A steady source of light projects a beam of light through the film sound track upon the photo-cell.

### Television

One of the earliest television patents of de Forest, No. 2,003,680 was issued June 4, 1935. It describes a television receiving and projecting method for scanning a strip of specially prepared film and electrically etching pictures thereon. Patent 2,026,872, issued in 1936, describes a means of producing a large size television image. The received image is recorded on specially treated film and may be later projected onto a screen by the usual projector. Sound is reproduced by a sound track recorded on the picture film at the same

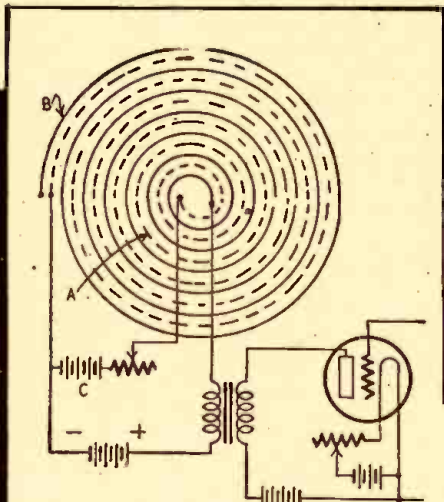

Fig. 9—A loudspeaker which works on air.

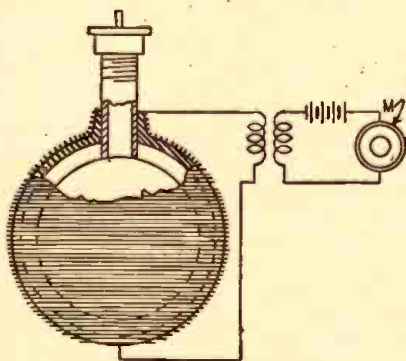

Fig. 10—Another interesting loudspeaker.

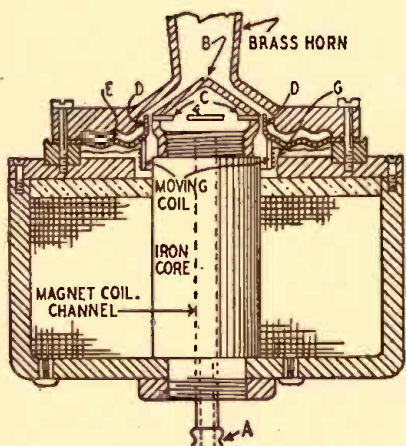

Fig. 11—Air-blast "very loud" speaker.

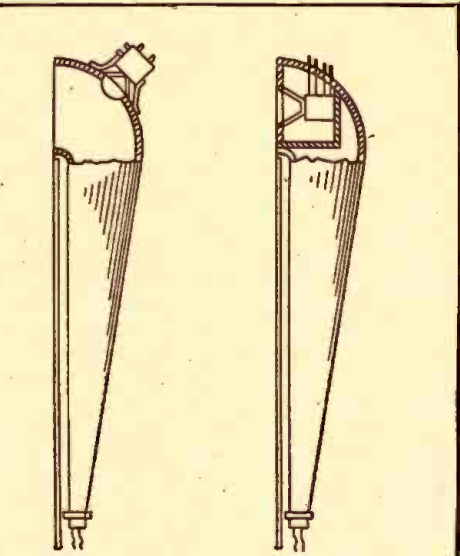

Fig. 12—Combined horn and cone speaker.

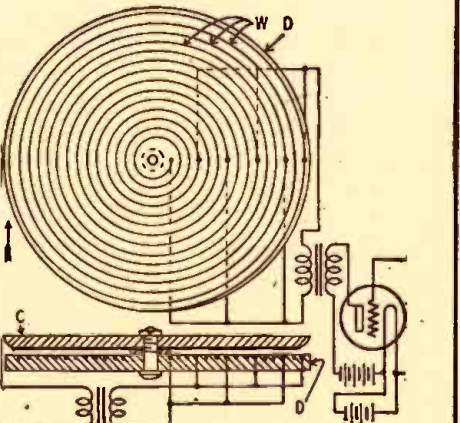

Fig. 13—Another heat-operated speaker.



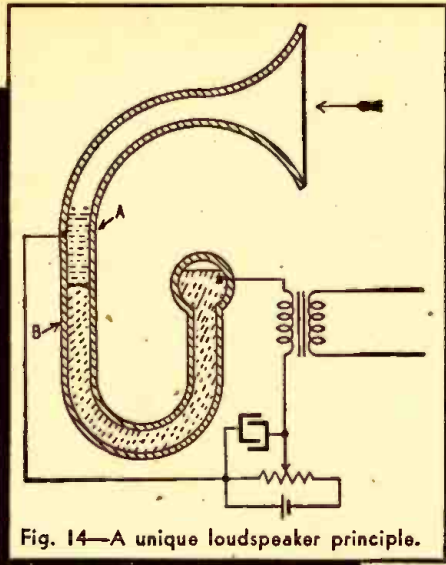

Fig. 14—A unique loudspeaker principle.

time the picture signals are recorded. An ingenious method for recording or etching the picture images on the coated film by an electrostatic discharge is described. The discharge is modulated by the received television signals. A following patent covers further developments of this idea and includes means for synchronizing the received images with the accompanying sound signals.

An idea for stereoscopic television is covered by patent 2,163,749. Radial scanning is one of the features here proposed. A cathode beam radial scanning system appears in patent 2,241,809 issued May 13, 1941. The cathode beam

is deflected back and forth by a rotating switching device; thus the beam traverses a non-repeating pattern on the screen.

### Television Sign

A television sign is described in patent No. 2,049,763 dated August 4, 1936. In the future we shall undoubtedly see many signs of this type along our highways. It is operated by remote control from a television station. A salient feature of this television sign is that practically any picture can be reproduced on its face, either in silhouette or halftone effect. The glow lamps on the surface of the sign are controlled by a switch directed by television signals, which may be picked up by a television receiver located near the sign. These signs may be operated out in the open country and a number of signs can be controlled at the same time from one transmitter.

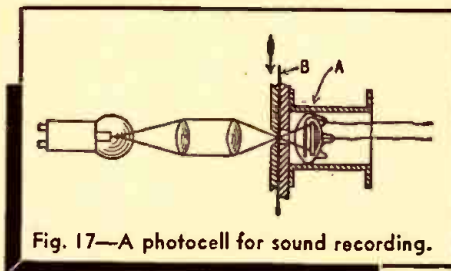

Fig. 17—A photocell for sound recording.

The patent describes the preferred form of the high-voltage glow tubes and the switching mechanism. In one

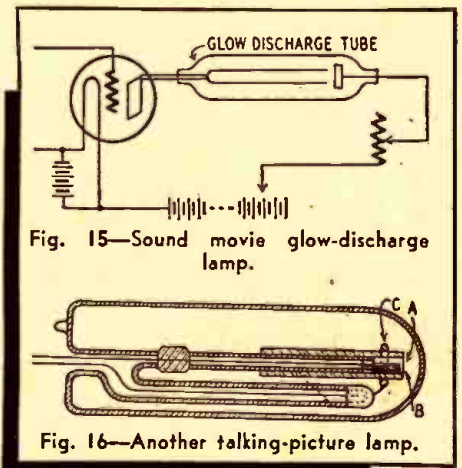

Fig. 15—Sound movie glow-discharge lamp.

Fig. 16—Another talking-picture lamp.

suggested form the sign might contain a hundred rows of glow tubes, with a hundred tubes in each row. Ten thousand glow tubes would be used in this case and thus a very good reproduction of the image realized. High voltage is fed to each glow tube as the commutator switch makes the proper connection, in accordance with the television signal directing it.

Many of the above inventions were not followed up, for one reason or another. They offer challenging opportunities for the engineer or experimenter today. Certain speakers, for instance, were not practical when 90 volts of B battery was a standard power supply but might be quite usable now that 450 or even 900 volts can be obtained if desired. These patents are worth study.



## E. I. CO. SOLD FIRST AUDIONS

(Continued from page 45)

sold 93 audions. In 1912 it sold 155 audions and in 1913 it sold 211, a total of 459. It should be noted that this compares rather well with all the de Forest companies combined, which from 1909 until the end of 1913 bought a total of 1,300 audions from McCandless.

The next runner-up in point of early purchase of audions was the Manhattan Electric Supply Company, which started with a single audion, bought from McCandless in September, 1911. But the Manhattan Electric Supply Company bought only 10 audions in 1911-1912.

The next fairly large user, second in point of sales to the public, was the J. H. Bunnell Company of New York. This company, however, did not start selling audions until January, 1912. During 1912-1913 they sold a total of 384 audions against the E.I.Co.'s 459.

The third concern to sell audions to the public was Wallace & Company. They did not start, however, until February, 1912; during 1912-1913 they sold a total of 280 audions.

A few other wireless supply companies also sold audions to the public, but their sales did not come anywhere near the totals cited above.

Of passing interest also is the fact

that Western Electric Company—who did not sell the tubes to the public, but used them for experimental purposes—during the same years bought 45 audions from the McCandless Company. The Marconi Wireless Telegraph Company of America, which during the year 1909-1913 bought a total of 74 audions, was in the same class. None of these were sold to the public.

For the record, it might also be noted that the E.I.Co. did not make much profit on their audion sales. They paid between \$1.50 and \$2.00 per audion tube to the McCandless Company and sold it to the experimenters and amateurs for \$4.00. This price was, of course, not just for the audion itself. The E.I.Co. mounted it on a substantial wooden base with five binding posts and socket; then it had to be wired, too. At such a price, little profit was realized.

The reader may be interested in the following taken from a forthcoming book by Mr. Gerald F. J. Tyne, *McCandless and the Audion*:

"The Electro Importing Company was the child of Hugo Gernsback, now publisher of RADIO-CRAFT, founder of MODERN ELECTRICS, ELECTRICAL EXPERIMENTER, RADIO NEWS, SHORT-

WAVE CRAFT, and similar publications, and entrepreneur extraordinary. Gernsback sold great quantities of wireless apparatus in the period 1908-1915, mostly on a mail order basis. Many amateurs of that day (including the writer) considered the E.I.Co. catalog as a second Bible. McCandless-made [de Forest] tubes were sold by the E.I.Co. under the name of the 'Electro Audion.'

"The 'Electro Audion' first appeared in the E.I.Co. Catalog No. 10 for the year 1911 on page 93b and was first advertised by them in MODERN ELECTRICS for July, 1911, on page 272. The last appearance of the 'Electro Audion' in the E.I.Co. Catalog was on page 11 of the 1913 issue. . . . In this connection the following statement made in this advertisement is worthy of note:

"When receiving from loud or nearby stations, the light will be noticed to flicker in the bulb, and the signals can be read without the use of a telephone receiver, this feature being found in no other detector."

"The E.I.Co. went out of business about 1920 and Gernsback thereafter devoted his talents almost exclusively to publishing."





# DE FOREST PATENTS

1902

1946

The most important de Forest patents have been described in two articles elsewhere in this issue. Dozens of other inventions would have been well worthy of mention had space been available. The following list, with dates of patents and a brief description of the main features of each invention (not necessarily the patent title) may be interesting to many readers.

716,000, Dec. 16, 1902, Apparatus for Space Communications  
 716,203, Dec. 16, 1902, Wireless Telegraphy  
 716,334, Dec. 16, 1902, Method of Communicating Through Space  
 720,568, Feb. 17, 1903, Space Telegraphy  
 730,246, June 9, 1903, Space Telegraphy  
 730,247, June 9, 1903, Wireless Telegraphy  
 730,819, June 9, 1903, Wireless Signalling  
 748,597, Jan. 5, 1904, Wireless Signalling Device  
 749,131, Jan. 5, 1904, Wireless Signalling Apparatus  
 749,178, Jan. 12, 1904, Wireless Signalling Apparatus  
 749,371, Jan. 12, 1904, Wireless Telegraph Receiver  
 749,372, Jan. 12, 1904, Art of Wireless Telegraphy  
 749,434, Jan. 12, 1904, Wireless Signalling Apparatus  
 749,435, Jan. 12, 1904, Wireless Telegraphy Generating Set  
 749,436, Jan. 12, 1904, Wireless Telegraph Range Finder  
 750,180, Jan. 19, 1904, Spark Production Control Method  
 750,181, Jan. 19, 1904, Device for Cleaning Ice from Antenna  
 758,517, Apr. 26, 1904, Art of Wireless Telegraphy  
 759,216, May 3, 1904, Wireless Signalling Apparatus  
 770,228, Sept. 13, 1904, Receiver for Space Signalling  
 770,229, Sept. 13, 1904, Wireless Signalling Apparatus  
 771,818, Oct. 11, 1904, Wireless Signalling Apparatus  
 771,819, Oct. 11, 1904, Wireless Signalling Apparatus  
 771,820, Oct. 11, 1904, Protecting High Frequency Apparatus  
 772,878, Oct. 18, 1904, Magnetic Detector  
 772,879, Oct. 18, 1904, Art of Duplex Wireless Telegraphy  
 806,966, Dec. 12, 1905, Wireless Telegraph System  
 822,936, June 12, 1906, Wireless Telegraph System  
 823,902, June 12, 1906, Static Valve for Wireless Systems  
 824,003, June 19, 1906, Wireless Telegraph System  
 824,637, June 26, 1906, Oscillation Responsive Device  
 824,638, June 26, 1906, Oscillation Responsive Device  
 827,523, July 31, 1906, Wireless Telegraph System  
 827,534, July 31, 1906, Wireless Telegraph System  
 833,034, Oct. 9, 1906, Aerophone  
 836,015, Nov. 13, 1906, Aerophone  
 836,070, Nov. 13, 1906, Oscillation Responsive Device  
 836,071, Nov. 13, 1906, Oscillation Responsive Device  
 836,072, Nov. 13, 1906, Aerophone  
 837,901, Dec. 4, 1906, Wireless Telegraphy  
 841,386, Jan. 15, 1907, Wireless Telegraphy  
 841,387, Jan. 15, 1907, Device for Amplifying Feeble Currents  
 850,917, Apr. 23, 1907, Space Telegraphy  
 852,381, Apr. 30, 1907, Wireless Telegraph Receiving System  
 867,876, Oct. 8, 1907, Oscillation Responsive Device  
 867,877, Oct. 8, 1907, Art of Detecting Oscillations  
 867,878, Oct. 8, 1907, Oscillation Detector  
 874,178, Dec. 17, 1907, Cautery  
 876,165, Jan. 7, 1908, Wireless Telegraph Sending System  
 877,069, Jan. 21, 1908, Magnetic Detector  
 879,532, Feb. 18, 1908, Space Telegraphy  
 894,317, July 28, 1908, Electrolytic Detector Electrode  
 894,318, July 28, 1908, Aerophone  
 894,378, July 28, 1908, Wireless Signalling Apparatus  
 913,718, Mar. 2, 1909, Space Telegraphy  
 926,933, July 6, 1909, Wireless Telegraphy  
 926,934, July 6, 1909, Wireless Telegraph Tuning Device

926,935, July 6, 1909, Wireless Telegraph Transmitter  
 926,936, July 6, 1909, Space Telegraphy  
 926,937, July 6, 1909, Space Telephony  
 943,969, Dec. 21, 1909, Space Telegraphy  
 966,539, Aug. 9, 1910, Transmitting Apparatus  
 973,644, Oct. 25, 1910, Aerophone  
 979,275, Dec. 20, 1910, Oscillation Responsive Device  
 979,276, Dec. 20, 1910, Space Telegraphy  
 979,277, Dec. 20, 1910, High Frequency Oscillator  
 995,126, June 13, 1911, Amplifier for Feeble Electric Currents  
 995,339, June 13, 1911, Space Telegraphy  
 1,006,635, Oct. 24, 1911, Space Telephony  
 1,006,636, Oct. 24, 1911, Space Telephony  
 1,025,908, May 7, 1912, Wireless Music Transmitter  
 1,042,205, Oct. 22, 1912, Duplex Wireless Transmission System  
 1,101,533, June 30, 1914, Wireless Telegraphy  
 1,123,118, Dec. 29, 1914, Signalling System  
 1,123,119, Dec. 29, 1914, Wireless Communication Secrecy System  
 1,123,120, Dec. 29, 1914, Space Communications Arc Mechanism  
 1,125,496, Jan. 19, 1915, Wireless Telephone Transmitter  
 1,134,593, Apr. 6, 1915, Electromagnetic Radiation Receiver  
 1,134,594, Apr. 6, 1915, Increasing Strength of Electric Currents  
 1,170,881, Feb. 8, 1916, Wireless Receiving System  
 1,170,882, Feb. 8, 1916, Telephone System Automatic Switch  
 1,171,598, Feb. 15, 1916, Radiotone Wireless Telegraph Spark Gap  
 1,177,848, Apr. 4, 1916, Method of Recording Fluctuating Currents  
 1,183,802, May 16, 1916, Range Teller  
 1,183,803, May 16, 1916, Wireless Telephone System  
 1,190,869, July 11, 1916, Quench Spark Discharger  
 1,201,270, Oct. 17, 1916, Oscillating Current Generator  
 1,201,271, Oct. 17, 1916, Oscillating Audion  
 1,201,272, Oct. 17, 1916, Telegraph and Telephone Receiving System  
 1,201,273, Oct. 17, 1916, Oscillation Generator  
 1,214,283, Jan. 30, 1917, Wireless Telegraphy  
 1,221,033, Apr. 3, 1917, Wireless Telegraph Signalling System  
 1,221,034, Apr. 3, 1917, Oscillating Current Generator  
 1,221,035, Apr. 3, 1917, Wire or Radio Communications Apparatus  
 1,230,874, June 26, 1917, Metallic Audion  
 1,299,356, Apr. 1, 1919, Radio Communication Apparatus  
 1,309,753, July 15, 1919, Vibrations Transducer  
 1,311,264, July 29, 1919, Oscillation Generator  
 1,314,250, Aug. 26, 1919, Current Pulse Reproducer and Amplifier  
 1,314,251, Aug. 26, 1919, Radiotelephony  
 1,314,252, Aug. 26, 1919, Oscillation Generator  
 1,314,253, Aug. 26, 1919, Wire or Radio Communication Apparatus  
 1,329,758, Feb. 3, 1920, Oscillating Current Generator  
 1,348,157, Aug. 3, 1920, Amplifier for Pulsating Electric Currents  
 1,348,213, Aug. 3, 1920, Radiotelephone System  
 1,495,959, Reissued Oct. 19, 1920, Wireless Telephone System  
 1,365,157, Jan. 11, 1921, Apparatus for Telegraphy or Telephony  
 1,365,237, Jan. 11, 1921, Endless Film Arrangement  
 1,375,447, Apr. 19, 1921, Means for Amplifying Currents  
 1,377,405, May 10, 1921, Audion Circuit  
 1,397,575, Nov. 22, 1921, Selective Audion Amplifier  
 1,417,662, May 30, 1922, Radio Signalling System  
 1,424,805, Aug. 8, 1922, Subterranean Signalling System  
 1,437,498, Dec. 5, 1922, Oscillation

1907

Forty Years of Electronics

1947



1,442,426, Jan. 16, 1923, Sound Controlled Light Variations  
 1,442,682, Jan. 16, 1923, Endless Sound Record and Mechanism  
 15,540, Reissued Feb. 13, 1923, Changing Motion to Electricity  
 1,446,246, Feb. 20, 1923, Recording and Reproducing Sound  
 1,446,247, Feb. 20, 1923, Light Controlling Means  
 1,452,827, Apr. 24, 1923, Telephone Device  
 1,466,701, Sept. 4, 1923, Light Variation Current Control  
 1,478,029, Dec. 18, 1923, Radio Receiving System  
 1,482,119, Jan. 29, 1924, Recording and Reproducing Sound  
 1,486,866, Mar. 18, 1924, Sound Producer  
 1,489,314, Apr. 8, 1924, Recording Sound  
 1,507,016, Sept. 2, 1924, Radio Signalling System  
 1,507,017, Sept. 2, 1924, Wireless Telegraph and Telephone  
 1,515,152, Nov. 11, 1924, Communication System for Trains  
 1,526,778, Feb. 17, 1925, Thermophone  
 1,543,990, June 30, 1925, Producing Musical Notes Electrically  
 1,552,914, Sept. 8, 1925, Telephone Device  
 1,554,561, Sept. 22, 1925, Sound Reproducing Mechanism  
 1,554,794, Sept. 22, 1925, Loud Speaking Device  
 1,554,795, Sept. 22, 1925, Radio Signalling System  
 1,560,502, Nov. 3, 1925, Sound Reproducing Device  
 1,561,596, Nov. 17, 1925, Indicating Device for Fluid Tanks  
 Des. 69,443, Feb. 16, 1926, Loud Speaker  
 1,629,152, May 17, 1927, Slot Cleaner for Motion Picture Machines  
 1,641,664, Sept. 6, 1927, Electrical Sound Reproducing Apparatus  
 1,642,363, Sept. 13, 1927, Telephone Device  
 1,653,155, Dec. 20, 1927, Talking Moving Picture Equipment  
 1,659,909, Feb. 21, 1928, Film Protecting Arrangement  
 1,659,910, Feb. 21, 1928, Slot Cleaner for Phonofilm Attachments  
 1,680,207, Aug. 7, 1928, Radio Signalling System  
 1,683,451, Sept. 4, 1928, Recording and Reproducing Sound  
 1,687,364, Oct. 9, 1928, Radio Transmitting System  
 1,693,071, Nov. 27, 1928, Sound Recording Device for Movie Cameras  
 1,693,072, Nov. 27, 1928, Shielding for Detector and Amplifier  
 1,695,414, Dec. 18, 1928, Talking Moving Picture Machine  
 1,695,415, Dec. 18, 1928, Talking Motion Picture Record  
 1,701,911, Feb. 12, 1929, Acoustic Apparatus  
 1,710,922, Apr. 30, 1929, Motion Picture Screen  
 1,716,033, June 4, 1929, Producing Talking Motion Picture Films  
 1,718,337, June 25, 1929, Loud Speaker Motor  
 1,720,544, July 9, 1929, Radio Receiving Apparatus  
 1,722,280, July 30, 1929, Photo Electric Cell  
 1,726,289, Aug. 27, 1929, Diffraction Microphone  
 1,736,035, Nov. 19, 1929, Sound Reproducing Device

1,738,988, Dec. 10, 1929, Sound Actuated and Producing Device  
 1,740,577, Dec. 24, 1929, Wireless Telegraph and Telephone System  
 1,761,619, June 3, 1930, Sound and Picture Recording Camera  
 1,764,938, June 17, 1930, Producing Talking Motion Picture Films  
 1,766,612, June 24, 1930, Sound Reproducing Device  
 1,769,907, July 1, 1930, Binaural Recording and Reproducing Sound  
 1,769,908, July 1, 1930, Recording and Reproducing Sound  
 1,769,909, July 1, 1930, Talking Picture Exciting Lamp Switch  
 1,777,037, Sept. 30, 1930, Binaural Recording Sound  
 1,777,828, Oct. 7, 1930, Sound Picture Photography  
 1,785,377, Dec. 16, 1930, Loud Speaker  
 1,795,936, Mar. 10, 1931, Sound Reproducer  
 1,802,595, Apr. 28, 1931, Automatic Photographic Sound Reproducer  
 1,806,744, May 26, 1931, Talking Picture Machine Drive Mechanism  
 1,806,745, May 26, 1931, Sound Producing Device  
 1,806,746, May 26, 1931, Luminous Discharge Device  
 18,108, Reissued June 23, 1931, Obliterating Parts of Talking Film  
 1,812,687, June 30, 1931, Sound Chamber and Set Frame  
 1,827,283, Oct. 13, 1931, Sound Reproducer  
 1,834,051, Dec. 1, 1931, Microphone  
 1,843,972, Feb. 9, 1932, Talking Motion Picture Apparatus  
 1,853,850, Apr. 12, 1932, Sound Reproducing Device  
 1,859,435, May 24, 1932, Sound-on-Film Phonograph  
 1,866,090, July 5, 1932, Sound Reproducing Device  
 1,873,558, Aug. 23, 1932, Gaseous Discharge Device  
 1,885,900, Nov. 1, 1932, Talking Motion Picture Attachment  
 1,888,910, Nov. 22, 1932, Synchronization in Talkie Photography  
 1,894,024, Jan. 10, 1933, Photographic Sound Reproduction  
 1,897,363, Feb. 14, 1933, Luminous Discharge Device  
 1,929,626, Oct. 10, 1933, Soundproofing Picture Camera  
 1,944,929, Jan. 30, 1934, Gaseous Discharge Device  
 1,992,201, Feb. 26, 1935, Apparatus for Reproducing Sound-on-Film  
 2,003,680, June 4, 1935, Television Reception and Projection  
 2,026,872, Jan. 7, 1936, Television Receiving Method and Apparatus  
 2,045,570, June 30, 1936, Synchronizing Televised Images  
 2,049,763, Aug. 4, 1936, Television Sign  
 2,052,133, Aug. 25, 1936, Television Apparatus  
 2,064,593, Dec. 15, 1936, Apparatus for Reproducing Sound-on-Film  
 2,122,456, July 5, 1938, Television System and Method  
 2,126,541, Aug. 9, 1938, High Frequency Oscillating System  
 2,163,749, June 27, 1939, Radial Scanning Television System  
 2,241,809, May 13, 1941, Radial Scanning with Cathode Beam  
 2,391,554, Dec. 25, 1945, Aircraft Speed and Course Indicator  
 2,410,868, Nov. 12, 1946, Means and Method for Altitude Determination

## Motion Picture Engineers Honor Dr. de Forest

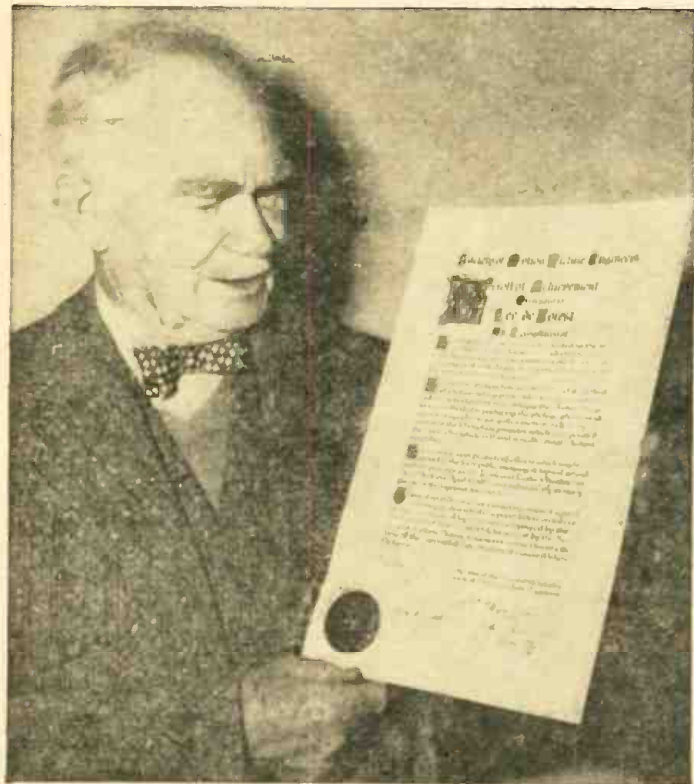

Dr. de Forest with the scroll which was presented to him on the occasion of his seventy-third birthday last August. The illuminated address was presented by the Society of Motion Picture Engineers in honor of the inventor of the fundamental audion and other developments important to the progress of sound motion pictures.





# TO THE FATHER OF RADIO

## Tributes to Dr. de Forest by Leading Figures in Radio

### From Major General J. O. Mauborgne, U. S. A., Retired

Engineer, soldier, artist, inventor; chief Signal Officer United States Army, 1937-1941; technical adviser to United States delegations at several international communications conferences; radio pioneer, inventor of numerous radio devices; author of "Practical Uses of the Wavemeter in Wireless Telegraphy" and brochures on radio and cryptanalysis.



How fitting that the January issue of RADIO-CRAFT is devoted almost entirely to a tribute to Dr. Lee de Forest, commemorating the fortieth anniversary of the invention of the vacuum tube with the control grid.

Since it was my good fortune to have been a reader of *Modern Electrics* in those early days, I take more than usual interest in the tribute to Dr. de Forest, whom I have known since his art-revising basic invention of the grid, which gave us the detector, oscillator, and amplifier, and established the foundation of all later work in electronics.

Let me raise my voice in the mighty shout which issues through your technical journal in praise of and congratulations to the Grand Old Man of Wireless, not only because he will live forever in the earth's Hall of Fame, but because he is—and always has been—a real American. May he live to be a hundred, knowing that he has achieved the greatest success a scientist can hope for.

—73—

### From Major General Harry C. Ingles

Chief Signal Officer, United States Army; former deputy commander, European Theater of Operations;



former chief of staff, Caribbean Defense Command; former director Army Signal School, Fort Monmouth.

It is a privilege to participate in RADIO-CRAFT's symposium honoring Dr. Lee de Forest and commemorating the fortieth anniversary of his invention of the grid vacuum tube.

With this invention, electrons were first brought under control and the foundations of the electronics industry were laid. The development of that industry, with its startling advances and its limitless horizons, has been one of our era's most important achievements.

Engineers of the U. S. Army Signal Corps yield to no other group in their admiration and respect for Dr. de Forest, and for his pre-eminent contributions to the science of communications.

—73—

### From Admiral J. R. Redman

Director of Naval Communications; member of Joint and Combined Communications Boards, Board of War Communications, State Department special committee on communications; vice-president in charge of engineering, Western Union Telegraph Co.



(Telegram)—I take great pleasure in joining with the many throughout the world in paying tribute to the achievements of Dr. Lee de Forest. We stand at the threshold of an electronic era, the effect of which on human life can scarcely be envisioned. For his great achievement in successfully developing the vacuum tube, we owe a debt to Dr. de Forest that cannot be repaid.

—73—

### From Brigadier General David Sarnoff

President and director, Radio Corporation of America; chairman of the board of director of the National Broadcasting Co.; brigadier general Signal Corps Reserve, U. S. Army; member of the executive committee, Institute of Radio Engineers; member of the Industry Advisory Committee of the United States Defense Communications Board; Cross of Honor of the Legion of Honor, 1940.

In two of America's great farm states, two boys grew up, one destined to create electric light and the other destined to shed enlightenment on the world through an electronic lamp. Thomas A. Edison, born at Milan, O., invented the incandescent light, and Lee de Forest, born at Council Bluffs, Ia., invented the audion. Both of these American men of science put the invisible electron to work for the benefit of mankind.

While Edison's Centennial will be ob-

served this year, de Forest will be celebrating the fortieth anniversary of his invention of the audion, or grid, vacuum tube. The fame of both men and the value of their contribution to science and society grows greater with time.

De Forest's audion, with its stream of electrons within a vacuum, forever challenging research, has been the key to



many major advances in science and industry. The electron tube is a beacon of progress in the vast field of electronics that extends throughout radio and into many other fields such as communications, the motion picture, and the phonograph.

De Forest's great contribution to electronics helps modern science to encircle the globe by radio and to echo back from the moon by radar.

—73—

### From the Federal Communications Commission

Charles R. Denny, radio lawyer, chairman, FCC; formerly general counsel, FCC; special assistant to the Attorney General; attorney, Department of Justice.



It is highly fitting that a grateful nation should take this opportunity to pay tribute to Dr. Lee de Forest. It is because of genius such as his that America has become pre-eminent in the field of electronics. Everywhere on this planet where electronics is ushering in a new era of accelerated human progress, men and women gladly acknowledge their debt of gratitude to this distinguished American scientist.



Laborers are being lightened, culture is more abundant, pleasure is multiplied, new horizons are opened, all phases of civilization are enhanced because of his achievement.

The Federal Communications Commission considers it a privilege to send its felicitations to the inventor of the modern vacuum tube on the fortieth anniversary of that revolutionary event.

—73—

**From Dr. E. F. W. Alexanderson**

Consulting engineer, General Electric Co.; former chief engineer, Radio Corporation of America; inventor of the Alexanderson alternator, multiple-tuned antenna and numerous other inventions in radio, television, electric ship propulsion, power transmission, and amplidyne control; past president, Institute of Radio Engineers; member Sigma Xi; Royal Swedish Academy of Science; decorated by King Gustav V of Sweden with Order of North Star.



When we look back upon the history of invention and industry, we find it extremely rare that one single invention has materially changed the course of events. The inventions of gunpowder and the printing press were among those exceptions. The electrical industry, the automobile, and the airplane, on the other hand, grew out of the consciousness of the scientific world without any definite starting point. There was radio and even radiotelephony before de Forest invented the vacuum tube with the control grid, but radio, as then known, was destined to become a small industry of limited usefulness. This was all changed by de Forest. With one invention, he opened up the electronics industry, which has already outgrown radio and is now on the way to become a vital factor in the power field for such purposes as power transmission, ship propulsion, and railroads, and also for industrial processes of heating and for production of materials such as aluminum and magnesium.

As an appreciation of de Forest's contribution, it may be said that he opened the gate which flooded the world with electronics.

—73—

**From Dr. W. R. G. Baker**

Vice-president, Electronics Department, General Electric Co.; former vice-president in charge of



engineering and manufacturing, Radio Corporation of America; president-elect, Institute of Radio

Engineers; director, National Electrical Manufacturers Association; chairman, Radio Technical Planning Board; chairman, National Television Systems Committee.

I was glad to learn that an anniversary number of RADIO-CRAFT would be devoted to honoring Dr. Lee de Forest, for it gives me the opportunity of adding my good wishes to those of his many friends in America.

To those of us who have had the privilege of knowing Dr. de Forest, we find his life of achievement a great source of encouragement and strength.

I am happy to join in this tribute to Dr. Lee de Forest for his untiring service these many years.

—73—

**From W. J. Barkley**

Executive vice-president, Collins Radio Co.; formerly general manager, de Forest Radio Company, Jersey City, N. J.; general manager Wireless Specialty Co., one of the earliest manufacturers of radio equipment.



It was my pleasure to have been associated with Dr. de Forest for several years. Knowing that he had more to do with the progress of modern radio than any other man, as demonstrated by his invention of the audion, it was also my pleasure to be able to help coin the phrase, The Father of Radio, while associated with him. His invention of the audion vacuum tube was the greatest development of modern times and will remain the foundation of all electronics in the years to come.

I take this opportunity of expressing to Dr. de Forest my heartiest congratulations and wishes for many more years of happiness in watching the development of electronics as the result of his outstanding work.

—73—

**From Dr. O. E. Buckley**

Research scientist; President (Former director of research) Bell Telephone Laboratories; member, Sigma Xi.



Hindsight is always easier than foresight, and it is now apparent that the advances being made in electron physics

during the turn of the century, as evidenced by the identification and measurement of the electron, were so fundamental that the electron amplifier was inevitable in our time. Yet no one could quite see it then. It remained for de Forest, with the incentive and intuition of the inventor, to provide the all-important grid as the control element. By this one act of producing a device which would truly amplify, de Forest, more than any other one man, precipitated our great modern developments in radio and allied fields.

Representing, as I do, the laboratory to which de Forest brought his audion and where it was developed into the serviceable high vacuum tube, I join the current tribute to this great inventor with particular significance and pleasure.

—73—

**From Dr. W. D. Coolidge**

Physical chemist, famous as the inventor of the Coolidge X-ray tube and of the ductile tungsten electric-lamp filament; head of Hanford division, Research Laboratory, General Electric Co.; vice-president and director of research of General Electric from 1940 to 1944.



The work of Dr. Lee de Forest has had so profound and so far-reaching an influence on our daily lives that it is already difficult to see how we ever got along without grid-controlled vacuum tubes. He is eminently deserving of the satisfaction which he must feel in seeing the universal appreciation, expressed in terms of use, which his device has received.

—73—

**From Prof. Frank E. Canavaci**

Consultant in electrical communications; Associate Professor of Electrical Communications, Brooklyn Polytechnic Institute; during the war, director of research and development, Universal Electronic Laboratories, New York City.

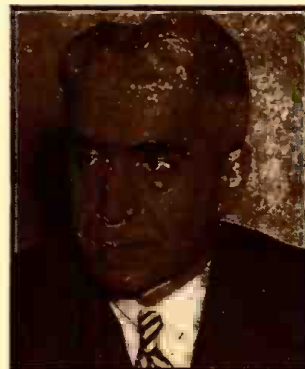

It is indeed with pleasure that I join with you and with all engineers and scientists in paying our respects to Dr. Lee de Forest on the eve of the fortieth anniversary of his invention of the grid-controlled vacuum tube.





Many citizens of Brooklyn, and some of our staff at the Polytechnic, recall the occasion when Dr. de Forest first demonstrated his audion before a gathering at the Brooklyn Institute of Arts and Sciences. In fact, our Dr. Samuel Sheldon, then Professor of Electrical Engineering and Physics at the Polytechnic, was also chairman of the Physics and Electrical Engineering group at the Brooklyn Institute. We are happy that Dr. Sheldon prevailed on Dr. de Forest to inaugurate the Electronic Age in Brooklyn.

May I also take this occasion to congratulate Mr. John V. L. Hogan, who assisted Dr. de Forest on that historical occasion.

We can never repay our debt to Dr. de Forest. His guerdon can be only our best wishes and affection. May he live long and enjoy the realization of the service his accomplishments have provided for mankind.

—73—

### From Dr. J. H. Dellinger

Physicist; chief of Radio Section, National Bureau of Standards, since 1918; chief of Interservice Radio Propagation Laboratory; chairman Radio Technical Committee for Aeronautics. Former chief engineer, Federal Radio Commission (1928-29). Delegate or technical adviser to numerous international radio conferences. Author of several radio books and many shorter treatises.



Through all these years I have been one of the admirers of Dr. Lee de Forest's ingenuity and perseverance. Radio is a great debtor to this pioneer.

—73—

### From William Dubilier

Famous as the inventor of the mica condenser which bears his name; holder of more than 300 patents in the field of radio, X-ray, and medical apparatus and submarine detection equipment. Author on many radio subjects.



It is most fitting that RADIO-CRAFT, one of the pioneers, is arranging the celebration of the fortieth anniversary of the greatest scientific development contributed to civilization.

Few people realize how the so-called vacuum tube has helpfully changed our mode of life and contributed toward the development and happiness of man. It has revolutionized communication—the real foundation of peace; for were it possible for all people to easily communicate with each other and exchange

viewpoints, there never would be wars. It has brought to all homes the finest music, up-to-the-minute news, current events, discussions, and other educational means not previously possible. The newspapers, for the first time, have a competitor. Truly, it is the foundation for one-world government. It has changed almost every useful electrical device.

Dr. Lee de Forest, as a pioneer, has valuably contributed and opened the door to these blessings. His name is today, and for many years will be, remembered.

—73—

### From Walter Evons

Vice-president Westinghouse Electric Corporation; vice-president and general manager, Westinghouse Radio Stations, Inc.



The gigantic world-wide radio broadcasting, communications, and electronics industries are undoubtedly the greatest tribute which can be paid to Dr. Lee de Forest for his brilliant invention of the three-element audion tube. The significance of these industries to nations and to individuals stands as a living monument to Dr. de Forest's pioneering efforts.

Because this invention has been so basic to the activities of our people at the Westinghouse radio stations, and the industrial electronics and home receiver divisions, I join with them in sending our special appreciation and good wishes to Dr. de Forest for his vital contribution to the radio-electronics industry.

We, in turn, join all the men and women of Westinghouse in expressing our personal gratitude to Dr. de Forest for the individual benefits and pleasures made possible by his great invention.

—73—

### From Dr. W. L. Everitt

Engineer, physicist, former chairman FCC; head of the electrical engineering department, University of Illinois; wartime director Operational Research Staff, Office of the Chief Signal Officer, U. S. Army; ex-president Institute of Radio Engineers; member Sigma Xi; author of technical works, including "Communication Engineering," and (editor) "Fundamentals of Radio."



It is seldom that great pioneers are able to see, within their own lifetime, the development of a great industry

founded upon their contributions. By now there can be no doubt that in a short list of the great forward advances in technology made by man, the development of means for controlling the flow of current in a vacuum tube, which was made by Dr. de Forest, must be listed prominently. To Dr. Lee de Forest, the world of the future as well as that of the present owes a great debt.

—73—

### From Dr. Alfred N. Goldsmith

Engineer, editor, and author. Former chairman of the board of construction engineers, National Broad-



casting Co.; director of research, chief broadcast engineer, vice-president, and general engineer, Radio Corporation of America. Now editor of Proceedings of the Institute of Radio Engineers; chairman of the sections on radio and motion pictures, American Standards Association; vice-chairman, Radio Technical Planning Board.

It is occasionally the good fortune of a man to create a device which opens practically unlimited vistas of accomplishment to his fellow workers, and which benefits civilization to a major extent. Dr. Lee de Forest, in producing the three-element electron tube, thus provided a powerful stimulus to his co-workers—an instrument of amazing potentialities to the fields of electrical, communications, and electronic engineering, and a source of untold benefits to the world at large.

It is difficult, even now, to appraise fully the amazing scope and value of the electron tube. It may well require decades or centuries fully to explore its capabilities.

But in the meantime historians, usually given to recording the day-by-day wrangles of governments and their representatives, might well turn aside to the more wholesome task of honoring such men as Dr. de Forest who constructively create the bases of our civilization rather than the elements of its destruction.

—73—

### From William J. Halligan

President, The Hallcrafters Co.; senior vice president, Army Signal Association; president, The Signal



League; chairman, Amateur Radio Committee of the Radio Manufacturers Association.



I had the pleasure of assisting in the celebration of Dr. Lee de Forest's seventy-third birthday on August 26. Fittingly enough, this birthday party was held in Chicago, where he began the experiments which resulted in the audion tube, one of the greatest inventions of all history.

Those of us in the radio industry owe him a tremendous debt, as do all in the allied electronics industries. It is a great privilege to participate in this issue of RADIO-CRAFT, which you have arranged in tribute to Dr. de Forest and his many achievements.

—73—

#### From R. V. L. Hortley

Famous as the inventor of the fundamental Hartley circuit. General communications engineer and theoretical research worker, at one time in charge of all wire-transmission research for Bell Telephone Co. At present theoretical consultant, Bell Telephone Laboratories, in which capacity he was instrumental in developing applications of servo mechanisms to radar and fire control during the last war.



We might try to evaluate the significance of Dr. de Forest's invention of the three-element vacuum tube by visualizing how things would be now if the invention had not been made. This, however, would be as vain as trying to predict the future. But we can picture with certainty many things which would not now be. Merely to catalog these would amply justify the conclusion that when Dr. de Forest added the grid to his tube he also added another dimension to the electric arts.

—73—

#### From R. A. Heising

Radio and patent engineer; best known as inventor of the Heising modulation circuit for radiophone transmitters; radio research engineer, Western Electric Co., 1914 to 1925, Bell Telephone Laboratories, 1925 to 1944; past president, Institute of Radio Engineers; designer and developer of ship-to-shore, transatlantic, and other radiophone circuits.



It is comforting to see the contemporaries of Dr. Lee de Forest of the days of the invention of the audion rising to pay tribute to that great inventor. They indeed understand the difference between the world before and after that important happening. While most of the world takes his contributions

along with liberty, free speech, and the ballot, as though they were natural phenomena instead of things worked or fought for, his friends of the early days are groping to find words to express to him their appreciation. May suitable words be uttered while his ears still hear, and stimulate him in work and health for years to come.

—73—

#### From John V. L. Hogan

Consulting engineer, pioneer of high-fidelity broadcasting; president Interstate Broadcasting Co. (WQXR); special assistant to the director, Office of Scientific Research and Development; past president, Institute of Radio Engineers; inventor of many radio and facsimile devices; author of "Outline of Radio" and shorter works; formerly assistant to de Forest and to Peter Cooper Hewitt.



My pleasure in giving Lee de Forest maximum credit and recognition for his constructive work in radio is increased by the fact that, while I was his chief (and only!) laboratory assistant during the winter of 1906-07, I attended the birth of the very first grid audion. Having seen the conception and nativity of that little glass baby, I nursed it through its earliest life, and made its first characteristic curves. I am happy that Dr. de Forest is still with us, and I want to congratulate him again, in this fortieth year, on his invention of the grid audion.

—73—

#### From I. J. Kaar

Manager Receiver Division, Electronics Department, General Electric Co.; chairman, Institute of Radio Engineers Committee on Television; chairman, Radio Manufacturers Association Committee on Television Receivers.



I doubt if anyone alive today can possibly visualize the magnitude and the effect upon humanity of Dr. de Forest's invention of forty years ago. The accomplishment and the things which have been built upon it are almost beyond comprehension. It is a privilege indeed to do homage to the Grand Old Man of Radio.

—73—

#### From Charles F. Kettering

Engineer, manufacturer, inventor, and educator; general manager Research Laboratories Division and

vice-president and director of General Motors Co.; inventor of automatic starting, lighting and ignition systems; chairman National Inventors Council.



Perhaps the most important date in the history of electronics is December 31, 1906, when a young experimenter named Lee de Forest inserted a third electrode in the form of a grid between the cathode and anode of a vacuum tube. The spectacular growth of electronics to an enormous industry employing over a million workers and benefiting untold millions of people in all parts of the world may be said to have begun on that date. Dr. de Forest's invention of the triode tube not only solved certain problems of itself, it also acted as a stimulus to the efforts of hundreds of later inventors who devoted their lives to improving it and adapting it to an ever-increasing number of uses. Even today the full extent of its utility and value has only been scratched. This ability to illuminate the path ahead is one of the characteristics of a truly great invention. To say that the three-element tube possesses this characteristic to a degree unique among modern inventions is the enormous tribute we must pay to Dr. de Forest.

—73—

#### From Dr. Irving Langmuir

Chemist; inventor of the condensation high-vacuum pump which made "hard" radio tubes possible; worked in the development of gas-filled tungsten lamps, electron discharge apparatus, molecular

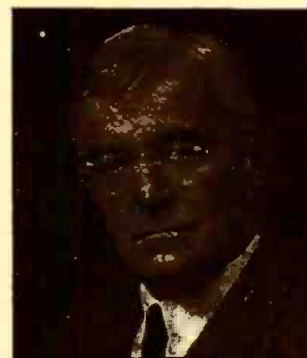

films, submarine detectors, and other projects; associate research director, General Electric Co.; past president, Institute of Radio Engineers, American Association for the Advancement of Science, American Chemical Society; member Sigma Xi.

Lee de Forest, in discovering that an electric current in a vacuum tube can be controlled by means of an interposed grid, laid the foundation for an extension of man's senses—an increase in speed and in sensitivity of many millionfold. The revolution has been as great in its way as that which may now be envisioned in other fields through our new control of nuclear power.

—73—

#### From George Lewis

Assistant vice-president, International Telephone and Telegraph Corporation and Federal Telephone and Radio Corporation; radio officer at New York Navy





Yard, 1915, and radio officer, design division, Bureau of Steam Engineering (later Bureau of Engineering) U. S. Navy, Washington.



I recall one of the many valuable contributions of Dr. de Forest to the advancement of the then infantile vacuum tube art in 1917, when I was chairman of the Vacuum Tube Committee for the Navy. This committee, probably the first official vacuum tube committee in the world, was set up when America entered World War I.

There were few vacuum tubes in the world then, but the Navy had experimented with them since 1913. The tubes, due to imperfect vacuum, had unreliable sensitivity and would glow with a bluish light—operators learned to pluck a tube to vibrate the wing (plate) and achieve "twilight zone blue" for greater sensitivity.

Dr. de Forest met with the committee and set up uniform tests for vacuum tubes. It was due primarily to his counsel, backed by his knowledge in the field which he himself had opened and was tirelessly exploring, that the Navy was able to take steps which not only increased the efficiency of their communications at the time but led eventually to their present high development in electronics.

—73—

### From Dr. Frederick B. Llewellyn

Research engineer and inventor; president, Institute of Radio Engineers, 1946; consulting engineer, Bell Telephone Laboratories; International authority on the design of vacuum tubes used for communication and electronic control purposes; inventor of ultra-high-frequency oscillator tubes and designer of stabilized oscillating circuits.



Great things are often simple ones as well. The introduction of a grid of wires between the cathode and anode of a two-element vacuum tube is simple in itself, but the consequences have been breath-taking in their effect. The grid changed the tube from a nonlinear circuit element into a device capable of accurate control of power. Alone and uncontrolled, power is useless and may be actually harmful, while, in contrast, controlled power is the foundation of technical civilization. The grid turned the vacuum tube into the versatile control device that has brought about tech-

nical advances previously inconceivable.

To the man who first introduced this simple but far-reaching change in the vacuum tube, to Dr. Lee de Forest, on this occasion of the fortieth anniversary of the audion, I am delighted to pay tribute.

—73—

### From Donald McNicol

Editor, engineer, and author. Past president (1926) Institute of Radio Engineers. Radioman since 1900. Author of "American Telegraph Practice", standard text on telegraphy. At present technical consultant, "Telegraph and Telephone Age" and general consultant in the communications field. His latest book, "Radio's Conquest of Space", has just been published.



During the years when de Forest was busy fashioning the first audions, he struggled, often alone, with limited funds and with little encouragement. It is of interest to note some of the outstanding scientists who were de Forest's contemporaries in 1907 when the audion was about to emerge from the laboratory and when he was 34 years of age: M. I. Pupin was 49; Nikola Tesla, 50; Elihu Thomson, 54; Oliver Lodge, 56; J. A. Fleming and A. H. K. Slaby, 58; H. von Helmholtz, 57; H. A. Rowland, 59; Alexander Graham Bell, Thomas A. Edison, and E. J. Houston, 60. Marconi was 33, and John Stone, 38. The electrical achievements of these scientists will be recounted and written about thousands of years from now, as has been true of the work of the ancient philosophers.

For radio needs the audion at first was not perfect. It arrived somewhat after the manner of the stork's deliveries—well endowed with the vigor to howl lustily. But the call that soon went out to pacify the howler and suppress the howls launched inquiries which spawned the scores of inventions that prepared the way for the electronic age.

—73—

### From L. K. Marshall

President, Raytheon Manufacturing Co.; Trustee, Tufts College.



When Lee de Forest saw the possibilities of making an electron relay out of an ordinary incandescent electric light bulb by adding two more elements, he may have foreseen what tremendous and awe-inspiring developments would follow. His energies then were concentrated upon a new and better method of controlling the flow of an electric current. The realization of the method he visualized was revolutionary in itself. His success in this objective unlocked the secret which made possible an entirely new age, a skyrocketing of the living standards of the whole human race, and vast, ever-expanding new industries.

His brilliant achievements are recorded in history and will forevermore serve as an inspiration to scientists and engineers the world over.

—73—

### From I. F. Mourontseff

Transmission tube research engineer; assistant to manager, Westinghouse Electronics Engineering Department.

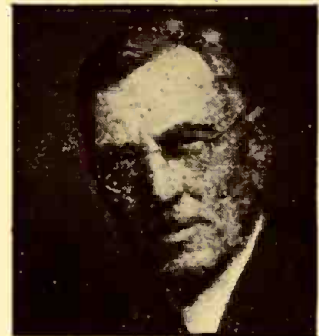

Beyond any doubt, de Forest's audion began a new era of radio-electronics and, through many subsequent developments, also became the heart of industrial electronics. Its value as amplifier of the most minute currents and voltages in an unheard-of proportion was appreciated not only by the radio receiver designers but also by the telephone companies and resulted in long-distance wire telegraphy and long-distance telephony.

But its greatest worth lay in the possibility of generating, in simple circuits, currents from the lowest audio to the highest radio frequencies measured in millions of cycles per second. With modulation applied to the grid of the audion, radiotelephony became an accomplished fact. With unprecedented ease it solved all problems on which many experimenters had been working with no appreciable success in their endeavor to realize radiotelephony by means of the Poulsen arc or high-frequency rotating alternators.

As in every great invention or discovery, there is in de Forest's epochal invention an element of inspiration or revelation (frequently called "act of subconscious mind"). This is not the result of painful logical thinking and cut-and-try practice, but a sudden message from Mother Nature flashing through the mind of the inventor. Logical work and scientific analysis usually come later in elaborating the details and explaining the observed facts. In de Forest's case the inspiration was the idea of interposing a grid between the cathode and anode of a tube; this made the whole difference between "to be" and "not to be." In all truth, Dr. de Forest is entitled to the honorary degree of "Father of Radio-Electronics."



**From E. A. Nicholas**

President, Farnsworth Television and Radio Corporation; former vice-president and member of the advisory board, Radio Corporation of America.



In a year in which we have witnessed a flash of light across the world, representing perhaps the ultimate application of science to destruction, it is most fitting that we pay honor to one who has done so much for the *constructive* progress of science.

The harnessing of the electron has proved one of the mightiest forces in the advancement of human welfare. For Dr. de Forest's leadership, his inspiration and his magnificent contributions to science, we are deeply grateful.

On this anniversary of the birthday of the three-element vacuum tube, we join in wishing for him many happy returns of the day.

—73—

**From Louis G. Pacent**

Consulting engineer; president, Pacent Engineering Corporation; pioneer manufacturer of radio parts and equipment; formerly consulting engineer on talking-picture sound equipment, Warner Brothers Pictures, designing for them the first all-power-operated motion-picture sound equipment. Author of a number of books and papers on radio subjects.

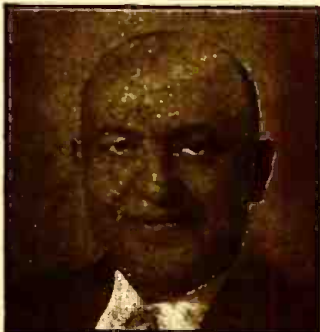

On this occasion of the fortieth anniversary of the invention of the electron tube by Dr. Lee de Forest, I join with the many friends and admirers of this great genius in paying homage.

I recall my first meeting with Dr. de Forest at his laboratory in the Metropolitan Life Building shortly after his tube was announced to the world, and although he saw clearly its many uses, his achievement was borne without self-glory. Since that time, I had the good fortune of seeing a good deal of him, and discussing early radio problems. From these meetings I acquired a great amount of radio sense. In 1917 he spoke at the Pratt Institute Engineering Alumni dinner, and made many predictions which have come to pass.

It is therefore proper and fitting that on this occasion we honor a great man, whose achievements and accomplishments are outstanding in furthering the progress of not only the radio art but also humanity at large.

**From J. R. Popple**

President, Television Broadcasters Association; vice-president, chief engineer and supervisor of programming, Bamberger Broadcasting Service; pioneer broadcaster (chief engineer of WOR since its opening).

Dr. de Forest is perhaps the foremost exponent of the electronic art. His developments have made possible not only advancement of wireless telegraphy and wireless telephony, but radio broadcasting and the newest communication medium of all-television.



The development of his vacuum tube made possible the first organized attempt to fly the Atlantic. It was the development of his vacuum tube that made possible transoceanic transmission of photographs.

Today everyone's life is touched by the magic of electronics, which employs the fundamental tube developed by Dr. Lee de Forest: persons at sea depend upon radio for safety; persons hard of hearing have been aided immeasurably by electronic hearing aids; people undergoing operations are more

certain of recovery through use of the electronic knife and electronic diathermy; the farmer in the fields owes much of his knowledge of modern world affairs to radio; the airplane is guided by radio; the wholesale merchant counts packages coming down belt lines by means of the electronic eye.

And now, thanks to Dr. Lee de Forest's pioneering, the greatest entertainment on Broadway and Hollywood will be brought to everyone's home through the great magic of television. We salute Dr. de Forest—a great inventor and a warm, human individual.

—73—

**From Haraden Pratt**

Communications engineer; vice-president, chief engineer, and director, Mackay Radio Corp.; vice-president and director, Federal Telephone and Radio Corp.; chairman of the Radio Technical Planning Board, 1946; chairman of Panel 8 (Radio



Communications) of the Radio Technical Planning Board; past president, Institute of Radio Engineers; committees on radio engineering standards; member, Sigma Xi.

(Continued on page 129)

**Resolution**

**Whereas**, the science of electronics owes a deep debt of gratitude to the fertile mind of Dr. Lee de Forest and his epoch-making three-element vacuum tube, and

**Whereas**, the acknowledged "Father of Radio," from his invention of the "grid" in 1907 to the present day, has continued his rich contributions to the expanding electronic art, and

**Whereas**, Dr. de Forest has played an important rôle in television progress as a natural sequence to his pioneering in sound motion pictures,

**Therefore, Be It Resolved** that the television art and industry, expressing itself through the Television Broadcasters' Association, Inc., record its affectionate greetings to the "Father of Radio" on the occasion of the Fortieth Anniversary of the "Audion," and

**Be It Further Resolved** that this Association hereby pays its warmest respects and deepest gratitude to this great scientist and inventor whose unending pioneering has helped bring about the realization of television and its immense possibilities toward Uniting All People.

By Order of the Board of Directors

(SEAL)

*J. R. Popple*  
President

*Haraden Pratt*  
Secretary-Treasurer

Dated this 31st day of  
October in the year 1946.

57





TELEVISION  
• NEWS •

# Low-Cost TELEVISION Is Here!

VISION Research Laboratories announces its postwar plan for bringing low cost television within the reach of amateurs, experimenters, and servicemen. With this plan you can save \$100 or more for only \$2.00!

by following the simple instructions included in our booklet.

**THE PLAN:** Amateurs, experimenters, servicemen now have access to the secrets of post-war television. As a result of a long period of development Vision Labs now brings you complete and detailed plans for the construction of a five or seven inch television-FM receiver incorporating the very latest design features. Also, there is a detailed parts list arranged to show you how you may substitute easily obtainable components for those which may be difficult to obtain.

**THE COST:** The design of this receiver requires nothing that is not immediately available. No waiting for delivery! The cost is ridiculously low! The plans show you how an expertly engineered set may be constructed at a cost between \$40.00 and \$60.00! Vision Labs can assist you in obtaining needed parts at the lowest possible cost.

**TIME:** This design is so simple and straightforward (yet sound and efficient) that only a few days of spare time work is required for the construction of this modern television receiver. Alignment of the set requires no special equipment and can be carried out in a few minutes

## ATTENTION: Servicemen

Realizing the tremendous need for inexpensive and practical test equipment for servicing television receivers, Vision Labs has also prepared a booklet showing complete details for the construction of a flexible and efficient Sweep Generator. This unit is a must for the service bench and can be made for the cost of about 1/10th that of any unit commercially available. No waiting for delivery! Just a few hours of your spare time required to build!

**EACH TELEVISION RECEIVER BOOKLET CONTAINS:** Schematic diagrams, detailed sketches, photographs and many pages of technical and practical information not only on how to build a 5 - 7 inch television receiver but on modern television receiver practice. Each booklet is clearly printed and in an attractive binder.

**EACH SWEEP GENERATOR BOOKLET CONTAINS:** Schematic diagrams, detailed sketches, photographs and complete detailed information on how to build a visual alignment sweep generator, covering from 6 - 100 mc with variable band width from 100 kc - 10 mc.

VISION RESEARCH LABORATORIES P.O. Box #52, Kew Gardens 15, N. Y.

Enclosed is \$.....(check or money order) for:

No. of Copies

..... Television Receiver Booklet @ \$2.00 ea.

No. of Copies

..... Sweep Generator Booklet @ \$2.00 ea.

Name.....

Address.....

City.....

Zone.....

State.....





# Wells Components—

ONE OR TEN THOUSAND  
MAY SOLVE A MAJOR  
PROBLEM FOR YOU!

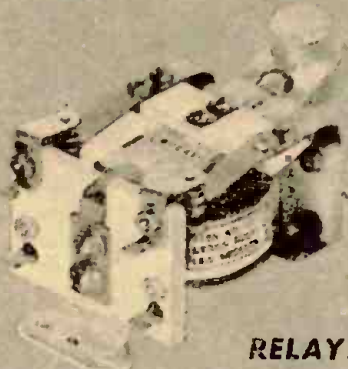

## RELAYS

We have one of the world's largest relay stocks—about a million. Hundreds of types and sizes of the leading makes are represented. Send for our Special Relay Catalog.



## VOLUME CONTROLS

More than one production line is moving because of our ability to make delivery of volume controls. Sizes range from 100 ohms to 5 megohms. List sent upon request.



## CONDENSERS

Micas, silver micas, tubulars, electrolytics, oil filled transmitting types, trimmers and padders are all available in quantity. Send us your requirements.

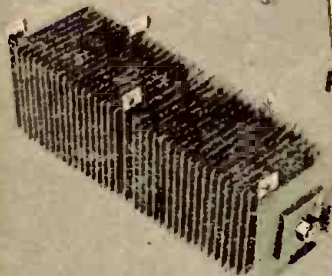

## RECTIFIERS

Heavy duty Mallory magnesium-copper sulphide and B/L selenium rectifiers attractively priced. Like all Wells components they are fully guaranteed. What are your needs?

## RESISTORS

Fixed, variable, wire wound, precision—hundreds of values and ratings.



## Immediate Delivery from One of America's Great Stocks of Guaranteed Parts

Manufacturers, laboratories, radio stations, telephone companies, distributors and dealers are finding Wells to be an immediate source of hundreds of scarce items. In many categories, our inventory is adequate for production runs. Guaranteed quality and lower than market prices represent highly attractive values. We invite you to consult us on any electronic procurement problem.

## WELLS AMATEUR RADIO DIVISION

### Just Arrived! Modulation Transformers

Built by R.C.A. to exacting standards, this high power modulation transformer will handle a kilowatt class B. The primary is rated at 550 audio watts and matches any class B tube such as an 810, 805, 203, 211, 813, 828, 75T, etc.

Impedance ratio—primary to secondary #1 — 1:1  
primary to secondary #2 — 25:1  
primary to secondary #2 Tap—625:1

We have priced this fine transformer at less than half of what you would normally expect to pay—only \$24.95. F.O.B. Chicago. Also Amertran 2 K.V.A. plate supply 6200 volt C.T. power transformers at only \$34.95, F.O.B. Chicago. All fully guaranteed.

You will find hundreds of similar values in our new Amateur Radio Catalog H-200. Send for your copy today.



4717 W. MADISON ST., CHICAGO 44, ILL.

Wells Sales Inc., 4717-Y West Madison St., Chicago 44, Ill.  
Please ship.....R.C.A. Modulation Transformers at \$24.95 each for which check (or M.O.) for \$..... is enclosed.  
Please send information on the following items: .....  
.....  
.....  
Name.....  
Address.....  
City.....Zone.....State.....



# BUILDING A TELEVISER

## An Experimental Receiver Which Has Given Good Results

**T**HIS IS NOT an ordinary construction article. Neither is a television receiver an ordinary radio set. Much detailed information given in stories on simpler sets will be

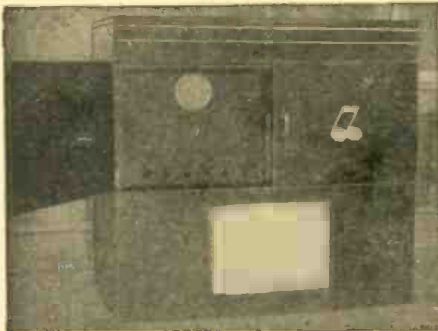

Photo. A—Complete sight-and-sound receiver.

omitted, for the simple reason that a technician capable of constructing the set does not need it, and the person who does need it would not be successful in constructing a televiser. The article will be divided in three parts, the first a description of the picture receiver; the second containing the sound portion and the third telling how to align the set and get it into operation.

The televiser appears in Photo A. The complete schematic diagram of the

receiver including parts values is shown in Fig. 1. A 6AC7 tube (V1) is used as the mixer tube with an overall gain of approximate unity. The input circuit of the mixer stage has a band pass of 6 mc when adjusted properly. The tuned link-circuit helps give this broad response. Selector switch S2 enables one of three preset channels to be switched into the circuit.

The h.f. oscillator is a shunt-inductance tuned, modified Hartley circuit using a 6J5 tube (V2). The small variable capacitor C7 enables vernier tuning of the oscillator frequency. The frequency can be varied approximately 1 mc with this capacitor.

The video and sound signals are separated in i.f. transformer T1 which has two secondary windings. Windings L15 and L17 are self-resonant at 12.75 mc while winding L16 is tuned to 8.25 mc by capacitor C13. Five video i.f. stages are used, giving a gain of approximately 10,000. Where the receiver is located only a mile or so from the television transmitter, such a large amount of gain is not required and two stages may be omitted. However, where reception is to be from a transmitter, located 25 to 50 miles away, five stages are necessary. The gain per stage is low, due to the heavy loading (small

shunt resistor values) required to obtain the necessary band width. Transformers T2, T3, and T4 incorporate rejector circuits to prevent sound i.f. signals from getting into the picture.

The video second detector uses one half of the double-diode 6H6 (V8). The detector is connected for positive output since only one video amplifier stage is used. The video amplifier stage will give 180-degree phase reversal of the signal, and thus apply a picture signal of the correct polarity to the grid of the picture tube. The video amplifier stage has a constant bandpass up to 4.5 mc. This wide response is obtained by placing inductances (peaking coils) L34, L35, L36, and L37 in the amplifier circuit to counteract tube and circuit capacitances.

Direct d.c. restoration is used in the amplifier stage to keep the black level on the picture tube constant. The picture tube grid is connected directly to the plate of the video amplifier tube V9, thus having its bias controlled by the average plate current of the amplifier tube. The plate current of V9 is in turn controlled by the bias developed across grid resistor R40 by the flow of grid current on positive video signal peaks. The bias will adjust itself due to the RC time constant of C51 and R40

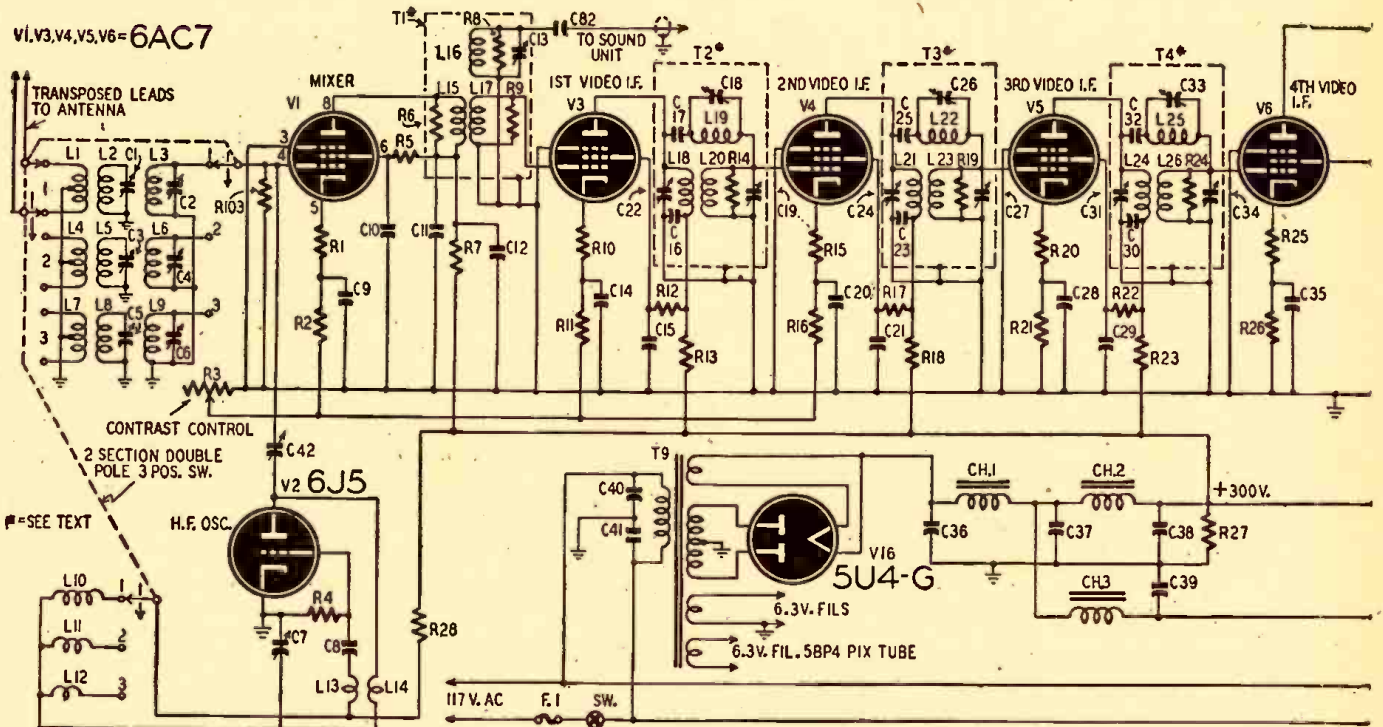

Fig. 1—The set uses 17 tubes (including rectifiers) plus the 5-inch cathode-ray tube. Slight modifications make it possible to use a



so that the black level is constant and does not vary with the a.c. picture content.

The second half of the 6H6 tube V8 is used as a clipper and separates the synchronizing pulses from the video signal. The clipper circuit is connected so that its output is negative (current flows on the alternation when the ground end of L31 is positive). From V8 the pulses go to the 6N7 tube V10, a double-triode tube, which acts as synchronizing pulse amplifier and second clipper. The pulses in the output of the second clipper are negative and are applied to the separating circuits consisting of integrating circuit R54-R55-C60-C61 and differentiating circuit R71-C70. The negative horizontal synchronizing pulse is applied directly to the horizontal sweep oscillator V14. The negative vertical pulse is fed to amplifier V11 where it is reversed in direction and then applied to the vertical sweep oscillator V12.

The two sweep oscillators V12 and V14 use type 6N7 tubes. The vertical oscillator is a standard blocking oscillator circuit and has a frequency of 60 cps. The horizontal oscillator V14 circuit is of the multivibrator type and the oscillator frequency is 15,750 cycles. Both oscillators have "hold" controls (R56 and R76) for varying the oscillator frequency slightly. The output of

each oscillator is fed to a balanced amplifier (V13 and V15) using a type 6F8 tube which is connected to the respective deflection plates. The amplitude of the voltage output of the vertical amplifier may be adjusted by height control R60, and of the horizontal amplifier by width control R86. This allows proper adjustment of the raster size.

A type 5BP4 cathode-ray tube with white screen and electrostatic deflection and focusing is used for the picture tube. This tube was chosen to keep expense down and the circuit as simple as possible. Normally the picture on this size tube is rather small, but by increasing the amplitude of the deflection voltages the picture can be enlarged until the corners of the raster disappear and the center portion of the picture is comparable in size to that on a 7-inch tube. Since most of the action takes place in the center of the picture, loss of the corners will not be noticed by the viewer. If a still larger picture is desired, a 7-inch tube has been introduced recently, which can be

substituted for the 5BP4 with some circuit changes. The 5-inch tube operates with approximately 1700 volts on the second anode while the 7-inch tube will require 4000 volts. Any tube larger than the 7-inch type will necessitate changing the deflection circuits as well

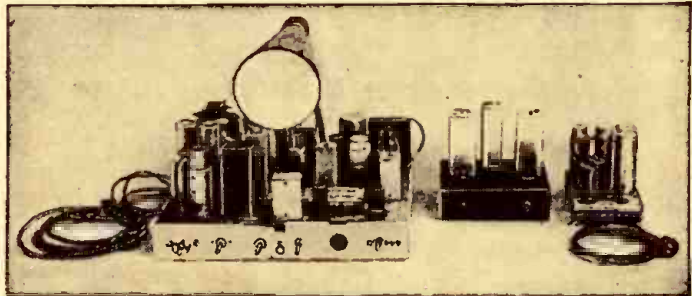
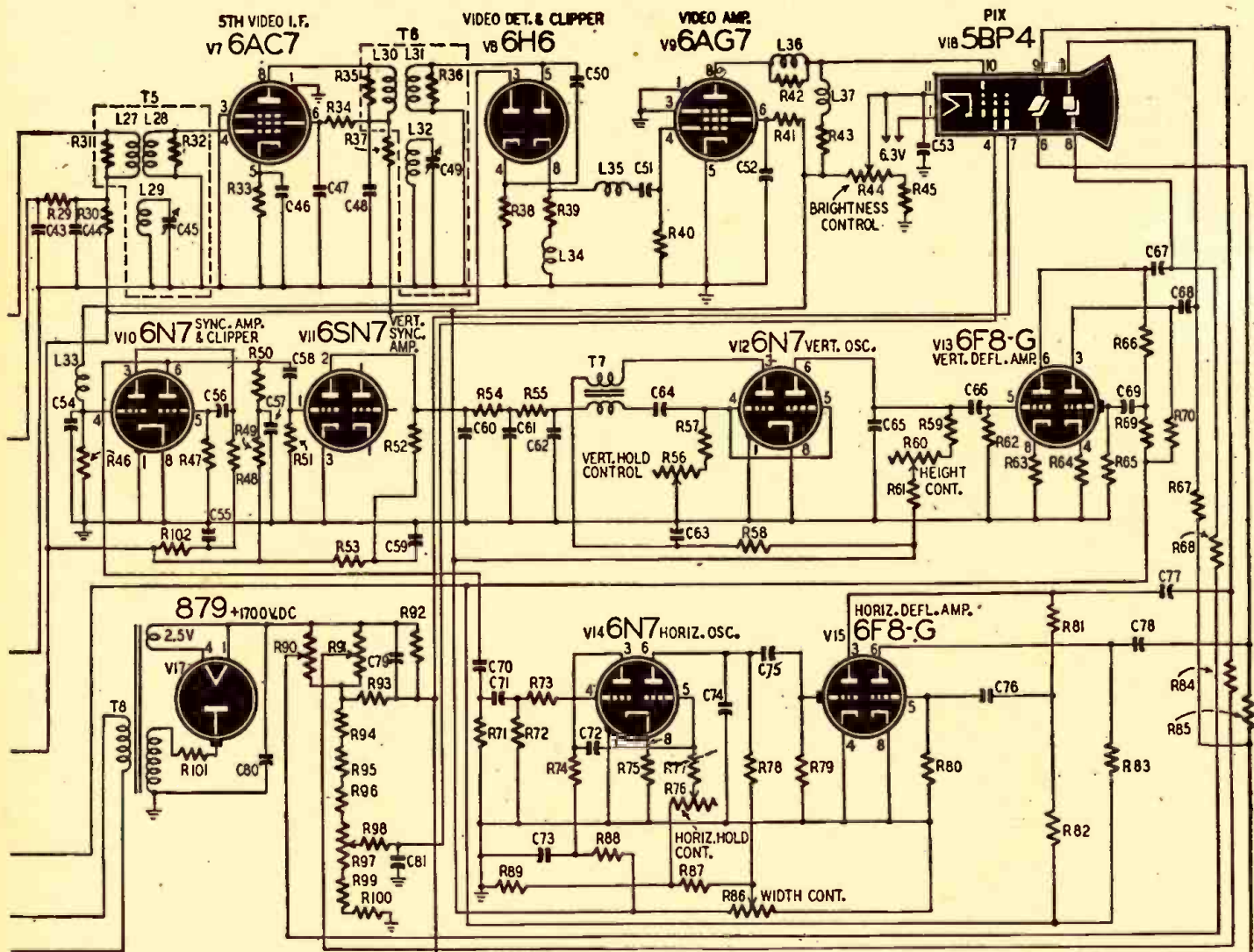

Photo B—The television receiver, FM section and FM power supply.

as the power supply.

Three power supplies are used in the receiver. The high-voltage power supply delivers 1700 volts at about 1 ma for the picture tube. A second supply delivers 300 volts to all the low-voltage circuits of the receiver except the FM sound unit. The sound unit is supplied from the third power supply which delivers 250 volts.

The sound portion of the receiver is a straightforward FM receiver circuit. The output of the mixer stage is coupled (Continued on page 118)



7-inch tube with this equipment. Note well that 1700 volts is dangerous to life! It's smart to be safe when dealing with high voltage!



# TRANSMISSION WITH LIGHT

## A Short-Range Light-Beam Transmitter and Receiver

**A** FEW years ago the author became interested in light-beam communication. Various experimental setups were put together until a practical system was evolved. It worked very well, especially considering that it was built almost entirely from the contents of a wartime junk box. In fact, the total expenditure was 40 cents for a neon tube purchased at a local hardware store. Many of the tubes had seen better days, while the stubby leads and battered casings of most of the small parts were evidence of considerable use elsewhere. Using parts of such uncertain past shows at least that the system will work even though circuit constants are not optimum.

Basically, a sound-on-light-beam system consists of three parts: A light source which can be intensity-modulated by sound waves, an optical system to carry the light from the transmitter to the receiver, and a pickup unit to convert the modulated light back into sound. In discussing the apparatus each part will be taken separately: First the receiver, then the transmitter, and last the optical system which connects the other two.

### THE RECEIVING EQUIPMENT

The receiver converts modulated light into sound. A photoelectric cell, with suitable voltage supply and amplifier, was the obvious choice for a demodulator. An RCA-918, polarized at about 80 volts d.c., was used. Similar gas cells, such as the RCA-868, would also work, provided the manufacturer's specifications concerning operating conditions were followed. A 2-megohm load resistor and a 0.1- $\mu$ f blocking condenser are used with the cell, the latter to keep d.c. from the grid of the first amplifier tube.

Almost any microphone amplifier

with sufficient gain could be used to build up the output of the cell. In this case a small 4-stage resistance-coupled amplifier was built and found to be satisfactory. It was desired to use the amplifier for other purposes, so the 918 was mounted in a separate housing (see photos) along with its load resistor and blocking condenser. This housing is connected to the amplifier by two detachable shielded cables. One of these ends in an Amphenol connector to fit the microphone input terminal of the amplifier. The other terminates in a phone plug which carries the polarizing voltage to the cell from a jack on the amplifier chassis.

The grid of the next tube, a 6J5, is run from a simple circuit which mixes the inputs from the 6SJ7 and from a connector for a phonograph attachment. Two tone controls are associated with the 6J5. The treble attenuator simply shunts the plate to ground. The bass control is in series with the coupling condenser to the next stage.

A 6C5 triode is used as a phase inverter for the push-pull output stage, a pair of 6L6's operated in Class A. A separate 10-inch speaker is connected to the amplifier chassis with a 4-prong plug.

The power supply is of standard design and furnishes 250 volts at about

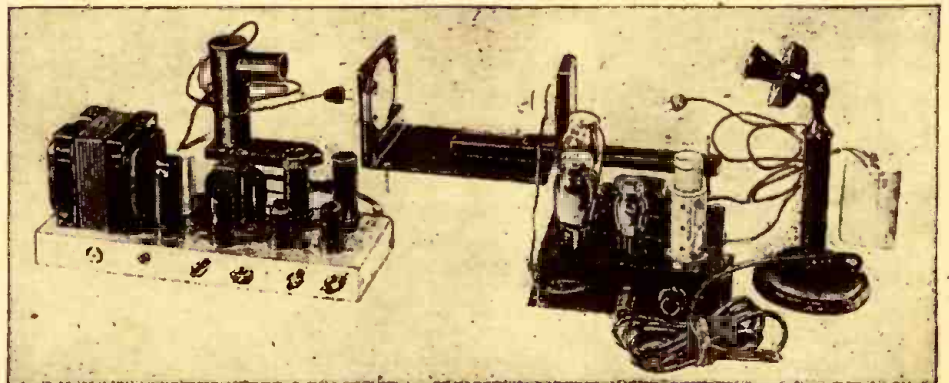

Receiver is at left, transmitter at right. Behind is photocell housing and optical system.

The first stage of the receiver amplifier shown in Fig. 1 is built around a 6SJ7. The circuit is designed to supply considerable gain. Hum may therefore occur, requiring installation of a shield around the tube socket and associated components. The grid resistor is particularly sensitive to stray pick-up. To prevent motorboating, the plate and screen supply is decoupled with a 50,000-ohm resistor and a 16- $\mu$ f condenser.

125 ma to the 6L6's. A voltage divider is connected to supply 80 volts for the photoelectric cell. This is adequately filtered by a 40- $\mu$ f condenser.

The mechanical layout is also straightforward, as may be seen in the illustrations. Some care must be taken in the location and shielding of the 6SJ7 stage, but beyond that the arrangement is not critical. Even on the small aluminum chassis used there was

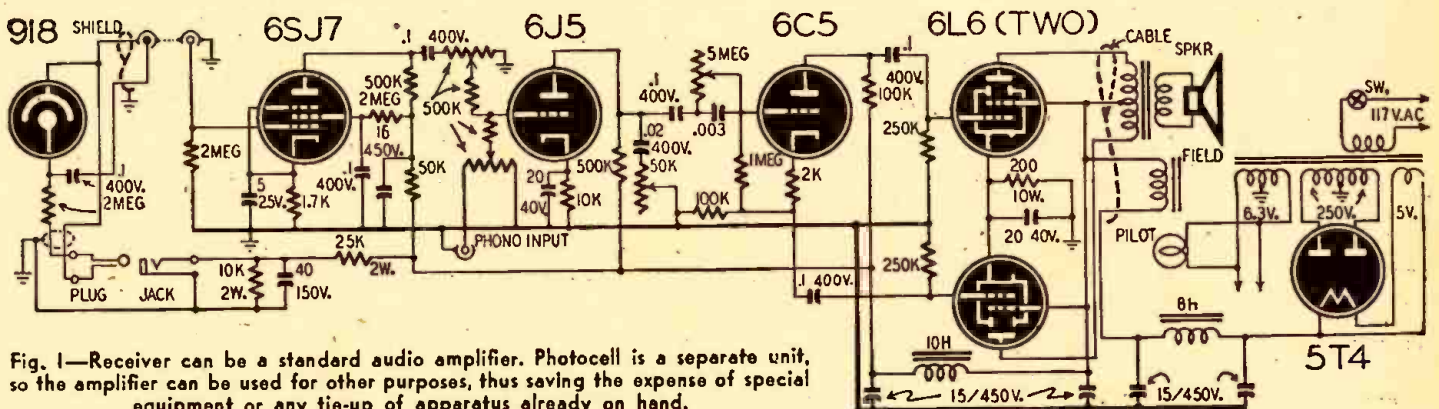

Fig. 1—Receiver can be a standard audio amplifier. Photocell is a separate unit, so the amplifier can be used for other purposes, thus saving the expense of special equipment or any tie-up of apparatus already on hand.



ample space for mounting components.

The housing for the photoelectric cell is composed of two old tube-shield cans. A hole was cut in the side of the top can. In this was soldered a smaller cylinder containing a 1-inch magnifying lens to focus all the entering light upon the cathode of the 918. This upper shield fits tightly down upon the socket assembly. In this latter a 4-prong Amphenol socket is clamped between the bottoms of the two rings which originally fastened the shield cans to a

For high intensities a carbon arc may be used.

All these methods have the disadvantage of expense. It was found that an ordinary neon lamp, in spite of its low brightness, could be used as a suitable modulated light source for short-range communication. A GE NE-30 was chosen because its anode consists of a small metal cup, 1/4-inch in diameter, while its cathode is a helix of wire spaced closely around the anode. When the tube is operating correctly the bot-

tery, while in the latter the battery should be disconnected.

For convenience, the neon tube is separate from the amplifier. Its socket is screwed to an adjustable mount which slides back and forth behind a 4-inch lens of about 12-inch focal length. Both lens and neon mount are fastened to an adjustable mount which can be set for different elevations of the light beam.

#### DETAILS OF OPERATION

Little need be said about operating the system. One should be careful to see that the spot of light at the receiver is focussed as small and as bright as possible by adjusting the neon tube behind its lens. The lens in the photocell housing should also be positioned for maximum volume. It will probably be found necessary to juggle the receiver and transmitter volume controls, and perhaps also the neon lamp voltage divider, to obtain best results. In general, the receiver gain should be as high as is consistent with a reasonably low noise level. (The amount of noise may vary greatly with the circumstances—daylight causes a distinct hiss; a.c. lighting, a strong hum.) When working properly the neon bulb should have a nearly constant light output, with changes in intensity just barely visible if at all. Sharp flickering may be due either to amplifier distortion or to an improper setting of the neon tube's voltage control.

The maximum range of this system is limited to the distance at which the input to the photoelectric cell from the neon bulb is above the general noise level. For this reason it is well to reduce internal hum to a minimum and also to shield the cell from all extraneous light.

Perhaps the greatest limitation is due to the relatively large diameter of the glow on the neon tube anode. As a result, the quarter-inch spot of light is rapidly magnified by the lens; so much so, in fact, that at ranges greater than a few feet the spot is much larger than the aperture to the photo-electric cell! A compound lens system to focus the beam to a point at any desired distance would greatly increase the range.

The whole purpose of the optical system is to concentrate the maximum amount of light from the neon tube anode, the *object*, onto the cathode of the photo-electric cell. We may assume that most of the light entering the aperture on the cell housing will impinge upon the plate of the 918. Our object, then, is to secure the largest possible intensity of illumination at the receiver.

#### INCREASING THE RANGE

It can be shown mathematically that for a transmitter lens whose diameter is small compared with its focal length,

(Continued on page 139)

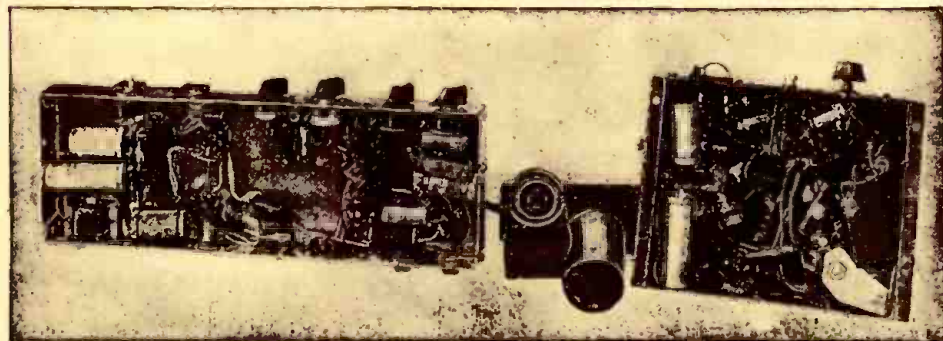

Under-chassis view of the two main units and a disassembled view of the photocell section.

chassis. The top shield slips over one of these rings while the other ring is clamped in the second can, which has been shortened to form the base and to guard the socket connections. The division is plainly seen in the photos. A wooden foot is screwed on the base to support the unit. Several sheets of paper glued over the large hole in the top of the upper can, together with a

tom of the cup is covered with a bright orange glow which may be projected with little difficulty.

#### THE TRANSMITTER AMPLIFIER

The neon lamp is excited by a 3-stage amplifier (Fig. 2) of ordinary design. The output section consists of a 2B6 operating into a 5,000-ohm load. The second triode only of this direct-coupled

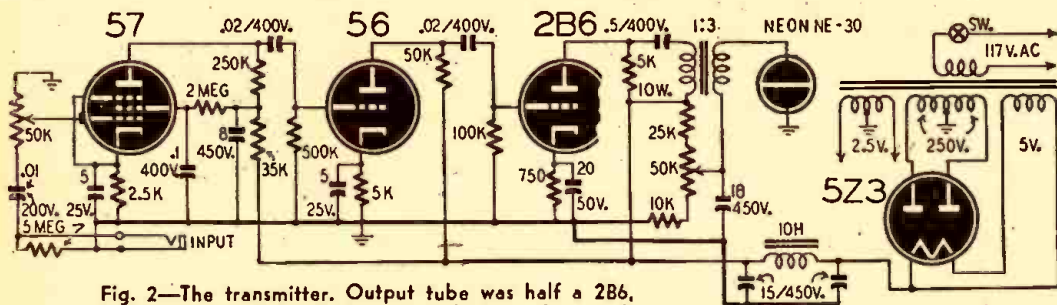

Fig. 2—The transmitter. Output tube was half a 2B6, but any power triode or pentode can be used.

thick over-all coat of black paint, effectively keep stray light from the photoelectric cell.

#### THE TRANSMITTER CIRCUIT

There are several methods by which one can intensity-modulate a beam of light. Commercial systems seem to favor the use of light gates with which the output from a source of constant brightness is varied in intensity by external means. In some of these, light is passed through apertures of a size which may be varied at audio frequencies. Besides this arrangement there are various other mechanical and electro-dynamical methods of modulation. Sound-operated light gates are entirely practicable. It is also possible to use a Kerr cell, an electrical device which polarizes light to a degree controlled by the input voltage.

On the other hand, one may readily modulate the source of light itself. Special discharge tubes have been made to supply a bright, easily modulated light.

tube was used and another type of output triode or pentode tube would no doubt work as well or better. Effectively in parallel with this resistor is the primary of a 3-to-1 audio transformer. A 0.5- $\mu$ f condenser is used to block the heavy d.c. plate current from the transformer primary winding. The GE NE-30 is in series with the secondary and the supply of about 150 volts d.c. The value is not critical. In any case, this potential must be high enough that at no time the gas discharge is completely stopped by large negative swings in the modulating voltage; otherwise there will be considerable distortion. The d.c. was obtained from an adjustable voltage divider across the amplifier B supply. An 8- $\mu$ f electrolytic condenser bypasses the a.f. to ground.

The remainder of the transmitter consists of two ordinary voltage amplifiers and a simple power supply. Input is from a carbon microphone or a phonograph pickup. In the former case 6 volts d.c. is supplied by an external bat-



# REPLACING THE RECTIFIER

## New Selenium Unit Makes Substitution Easy

THE newly-developed selenium rectifiers may prove to be a boon to radio manufacturers and servicemen who handle three-way portables and small a.c.-d.c. sets. These stacks are designed primarily to replace 117Z6, 117Z3 and OY4 tubes but are equally useful in replacing many other types of rectifier tubes when the 100-milliamperere current rating is not exceeded.

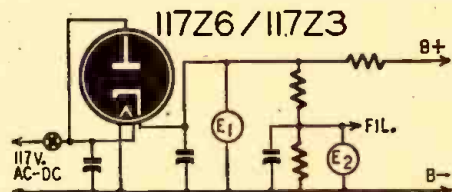

Fig. 1—Easily-replaceable type of rectifier.

The Federal model 403D-2625 illustrated consists of five circular plates, 1¼ inch in diameter, mounted in a stack 9/16 inch thick. Servicemen will find this useful in converting small battery radios to a.c.-d.c. or three-way operation with very little trouble. Its small size makes it possible to find a place for it on almost every radio chassis without drilling socket holes or using outboard power packs.

The rectifier stack has two distinct poles, positive and negative, corresponding to the plate and cathode of the

vacuum tube, and can be inserted into the circuit as such. The positive side, denoted by a red dot on the lug, is equivalent to the cathode, while the negative side functions as the plate. Soldering the stack into the set in this manner constitutes the entire replacement operation unless the filament of the tube was linked to other parts of the circuit, in which case a resistor is used to replace the rectifier tube filament.

Installation of the selenium rectifier is very simple as indicated in photos A and B. The set shown is a typical three-powered portable using a 117Z6 rectifier. The filament is not interlocked with any other component in the set (see Fig. 1). Therefore it is only necessary to insert the stack into the circuit along the lines outlined in the previous paragraph. Solder the positive side on pin 4 (cathode), the negative side on pin 5 (plate), and the installation is over.

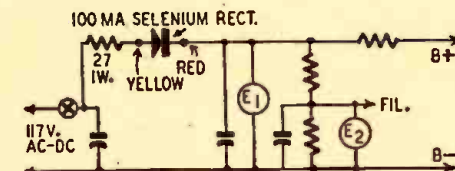

Fig. 2—Selenium rectifier in place of 117Z6.

Only four tools are required to perform the entire seven-minute operation

—a soldering iron, screw driver, socket wrench, and a pair of long-nose pliers. First the chassis is withdrawn from the cabinet and the tube is removed from the socket. Extension leads are then soldered on the rectifier stack. It is recommended that the positive lead be connected with red wire to distinguish it from the negative lead, which is usually yellow or black. (Photo A)

Whenever possible the stack should be installed underneath the chassis. However, in this case, as is the case with many portables, though the stack is only 1¼-inch in diameter, it did not fit underneath the chassis and was inserted from above in the space formerly occupied by the tube. In this latter case some type of protective covering must be provided.

The leads from the stack are drawn through the center of the tube socket and soldered to the appropriate pins, the red lead on pin 4 and the yellow one on pin 5. The set is then turned on. If the rectifier has been installed correctly, it should start operating immediately, Photo B. Finally a protective covering, which is supplied with the rectifier, is placed around the stack and tightened to the chassis via a screw and nut. Chassis is then put back in cabinet and the job is done.

After installation of the rectifier check the filament voltage. If it is too high for normal tube operation, insert a 27-ohm resistor in the line just before the rectifier to bring the operating voltage of the filament back to normal. The altered circuit is shown in Fig. 2.

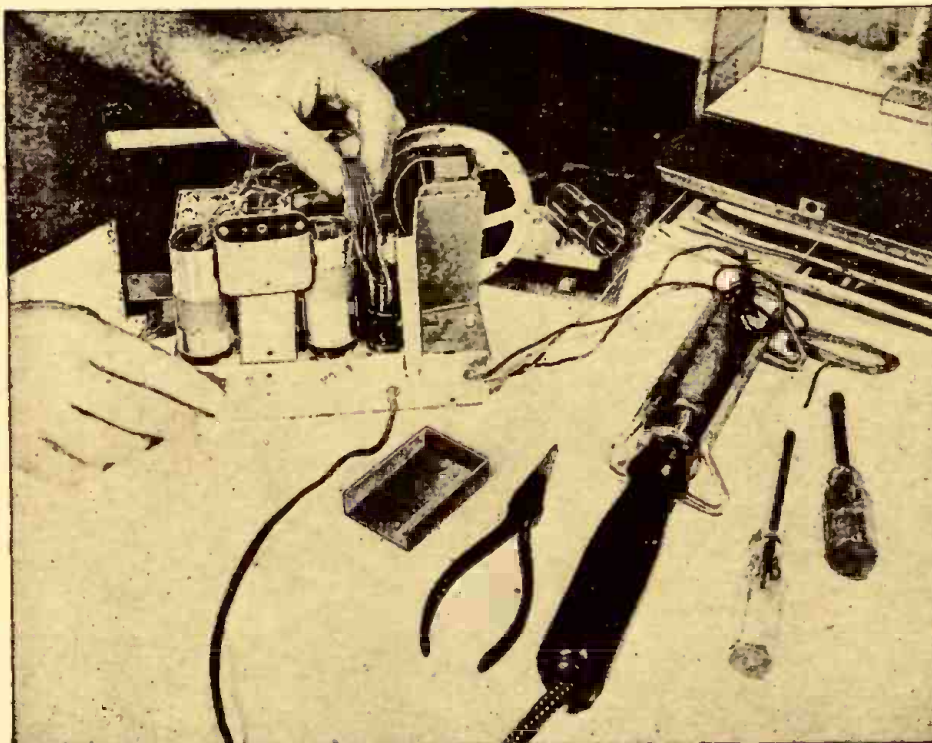

Photo A—First step in replacement—inserting rectifier leads in former tube socket.

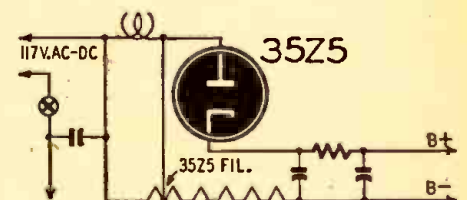

Fig. 3—Pilot lamp and 35Z5 offer problems.

If the selenium rectifier is used to replace the rectifier tube of a set using a 35Z5, the replacement problem is slightly more complex. Fig. 3 shows a typical receiver power supply using a 35Z5. We know that if the rectifier tube is removed, a voltage-dropping resistor must be inserted in the filament line to compensate for the resistance of the 35Z5 filament. The 35Z5 draws 35 volts at .15 ampere. We know that this is equivalent to a 220-ohm resistor.

(Continued on page 96)



# THE CINEMATIC ANALYZER

## Part II — Construction and Adjustment of the Analyzer

**T**HE first advice to the would-be constructor of the cinematic analyzer is: Don't attempt to construct it—unless you already have the cathode-ray oscilloscope which constitutes an indispensable part of it; unless you already have had plenty of experience in building measuring apparatus. Construction of the analyzer and putting it into operation require technical knowledge and skill usually lacked by the newcomer to the field.

Now that—to avoid all misconception—we have placed you on your guard, remember that in the preceding article we explained the principles of the cinematic analyzer and brought to light its great advantages. We also noted its purpose and theory in a general fashion, without giving the complete schematic.

The schematic diagram is given in Fig. 1. It does not include the oscilloscope, which may be any model in which the sweep can be effected equally well by a saw-tooth time base or by the sinusoidal voltage from the line.

In the left part of the schematic, surrounded by the square in broken lines, is the assembly which permits the use of the analyzer as a panoramic receiver. This part of the apparatus may be omitted, without thereby abandoning its use for panoramic reception. It is necessary merely to connect to the input marked R.F. the plate of the converter tube of any radio receiver, as explained in the preceding article. In this case the analyzer becomes a panoramic adapter.

### THE PANORAMIC RECEIVER

Examining the hookup of this optional part of the apparatus, we note

that it is the classic frequency-changer circuit with a 6K8 triode-hexode. The antenna and oscillator coils are the same as those employed on any superheterodyne, provided it has an intermediate frequency of 460 kc. (This falls midway between the two popular American intermediate frequencies, 455 and 465 kc, and coils for either of these will be satisfactory in practically all cases.—*Editor.*)

Note at all times that it is NOT advisable to use coils of high quality. It is necessary that the tuned circuit pass a frequency band 100 kc wide. On the short waves, most coils are sufficiently broad to pass such a band without notable attenuation at the extremities. However, it may be necessary to broaden the tuning of medium-wave coils with resistors in the order of 10,000 to 50,000 ohms.

The coil-condenser circuit connected in the plate circuit of the 6K8 should be tuned to 460 kc and should also have a pass-band of 100 kc. An i.f. winding with its trimmer may be used. Even though the coil may be of poor quality, it is best to broaden it with a resistor in the order of 20,000 ohms.

To check the functioning of this part

of the assembly, it is sufficient to connect its output to the i.f. input of a receiver, of which the i.f. should be tuned to 460 kc.

### WIDE-BAND AMPLIFIER

The first stage of the analyzer proper is equipped with a 6K7 variable-mu pentode tuned to 460 kc, and having a

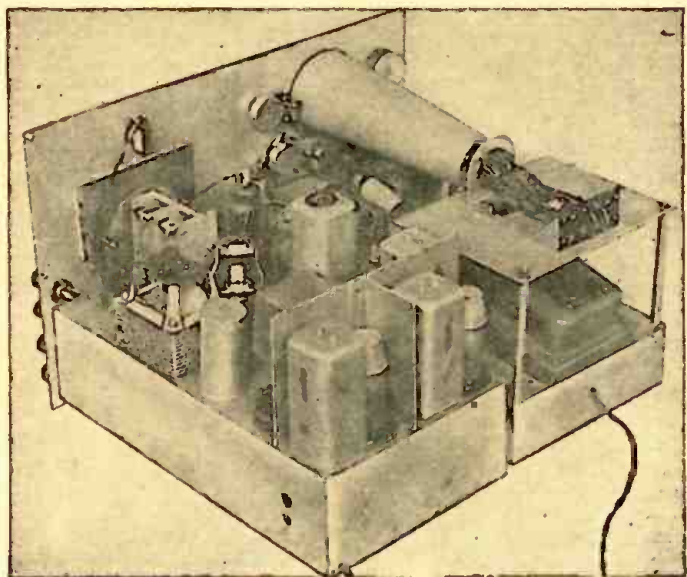

Rear view of the French Analyzer and its accompanying oscilloscope.

pass-band of 100 kc. The sensitivity of this tube is controlled with a 10,000-ohm potentiometer inserted in the cathode circuit. The output transformer is broadened with 20,000-ohm resistors across both windings. The resistor across the secondary is a potentiometer with scale calibrated from 1 to 100. Its

(Continued on following page)

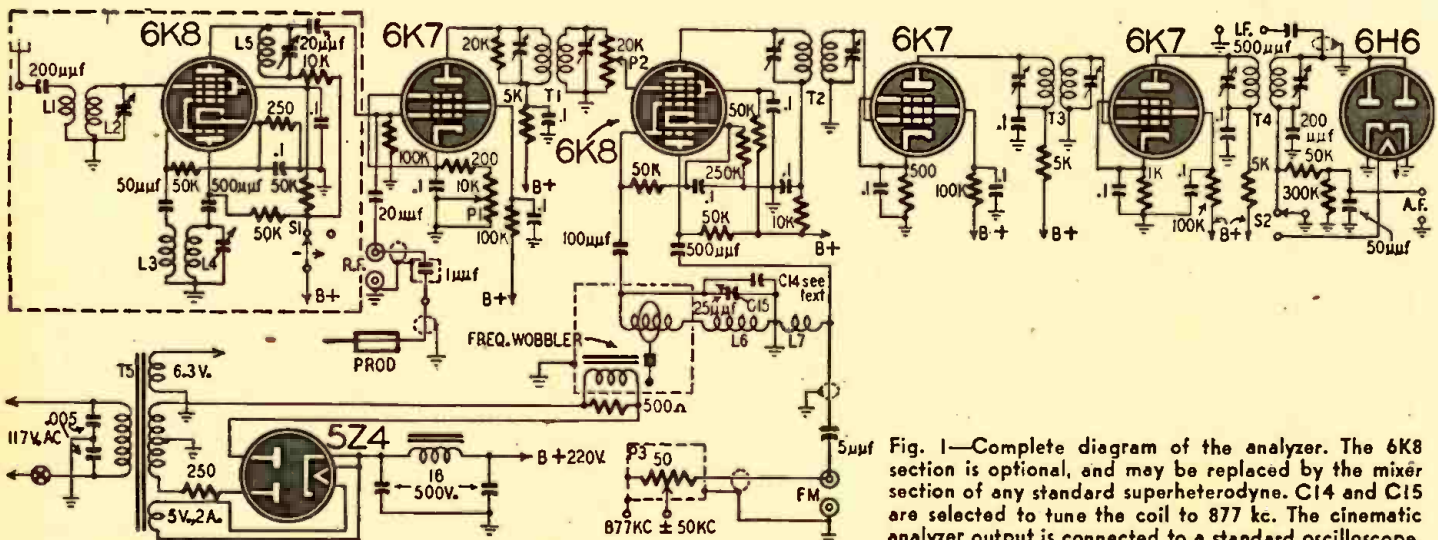

Fig. 1—Complete diagram of the analyzer. The 6K8 section is optional, and may be replaced by the mixer section of any standard superheterodyne. C14 and C15 are selected to tune the coil to 877 kc. The cinematic analyzer output is connected to a standard oscilloscope.



taper should be linear. By applying to the grid of the following tube a greater or lesser part of the voltage across the secondary, this potentiometer serves to measure gain, as was explained in the preceding article. The two posts marked R.F. permit the application of signals to the input of this stage. For convenient testing of various signals from the receiver under examination, a shielded coaxial cable is used. The inner conductor is connected to the "hot" post and the shielded to the grounded one. The cable may be two or three feet long. It should be a very low-capacity type. A con-

offers no remarkable peculiarity, the oscillator is distinguished by the fact that it is frequency-modulated over a range of  $\pm 50$  kc, at a rate of 60 cycles per second.

This frequency modulation is—as we have already stated—accomplished with the aid of an inductance *variator*. To this effect, the tuned winding of the oscillator grid circuit is divided in two parts, of which one, including approximately one-third the number of turns, carries in its magnetic field a short-circuited turn attached to the end of a magnetic vibrator.

Various methods of constructing such a vibrator suggest themselves to the ingenious technician. Leaving him complete latitude as to his choice, we limit ourselves to giving several practical suggestions.

In the first place, one could use — with slight modifications — an existing vibrator of the kind used in automobile radios.

But it is probably easier to use the driving unit of an old electromagnetic loudspeaker. Its windings carry the rectified current from one-half the secondary of the power-supply transformer, as indicated in the schematic.

Finally, a technician with a knack for small mechanical jobs can construct a vibrator according to the design given in Fig. 2. The magnetic core is composed of four laminations stacked on each other, each lamination about 1/32 inch thick. The two exterior laminations do not extend to the end of the pole pieces (see figure), thus concentrating

the lines of force in the gap. The magnet is excited by the two windings in series, each containing 250 turns of No. 28 enamel wire.

The vibrating reed is a thin blade of steel. The armature of soft iron is simply a rectangle tinplate cut from an old tin can and bent around the reed. Watch that this armature is not placed in the exact center of the gap, but a little forward of it. (See profile view of Fig. 2). Finally, the short-circuited turn is made of a piece of heavy copper wire soldered or brazed to the top of the armature.

The equipment is assembled with the aid of three machine screws which secure the laminations and reed on a sheet of bakelite. The tuned winding is also fixed on this support, as are two pairs of lugs, one pair of which connects to the winding, the other to the field coils of the electromagnet.

If the vibrator is to function correctly, it is necessary that the natural frequency of the reed be very close to 60 cycles per second, but not exactly to this value. A good practical value is between 62 and 65 cycles. Under these conditions, variations in the exciting current have no influence on the amplitude of oscillation. *The natural frequency of the reed may be varied by modifying the weight of the soft-iron armature, or by moving it slightly one way or the other along the reed.*

#### SELECTIVE AMPLIFIER

At the output of the frequency-changer tube, we find signals whose frequency is equal to  $877 - 460 = 417$  kc, frequency-modulated with a  $\pm 50$ -kc —deviation. These signals are amplified in the two stages equipped with 6K7's. The three transformers tuned to 417 kc must be extremely selective—their pass-band should not exceed 6 kc. Transformers of high quality and loose

*(Continued on page 116)*

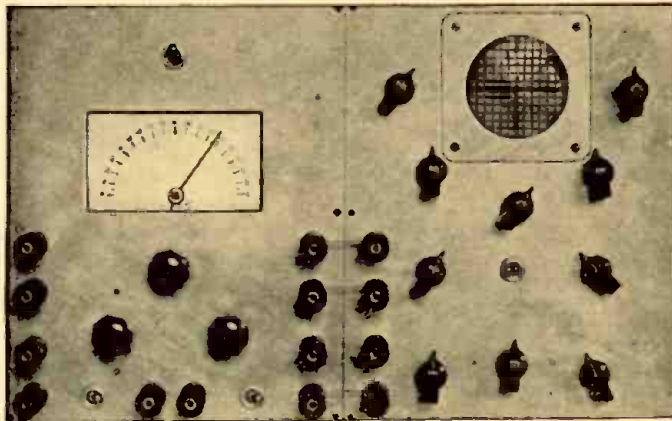

Panel view of analyzer and the oscilloscope with which it is used.

denser of about  $2 \mu\text{f}$  is connected in series with the inside conductor, close to the tip of the test prod. Such a condenser may be made by twisting together two pieces of insulated No. 24 wire for a length of three-quarters of an inch. At the free end of the low-capacity condenser, the inside conductor terminates in a test prod.

#### FREQUENCY CHANGER

The signals amplified by the 6K7 are applied to the control grid of a 6K8. The oscillator section of this tube is tuned to 877 kc. If the rest of the stage

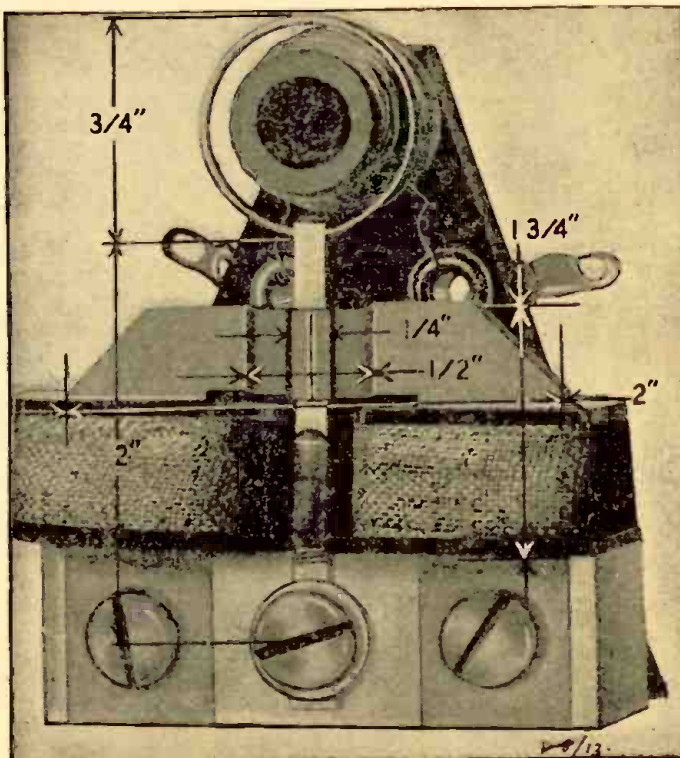
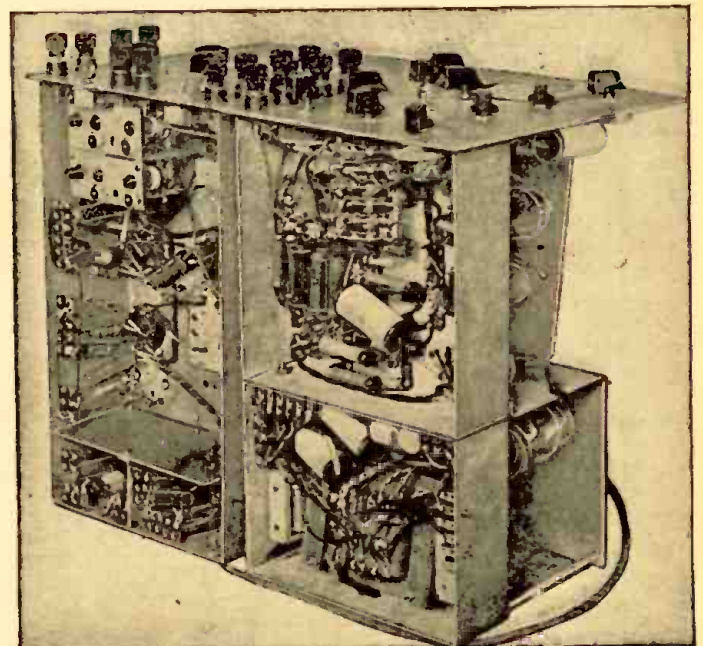

Fig. 2, left—Dimensions, Bernhardt vibrator described last month. Below—The under-chassis view may be useful to constructors as a reference, though layout conforms to the French components used.









# THE 'SCOPE—A REPAIR TOOL

**W**HEN the serviceman picks a set and says, "Now, let's see what's wrong with this baby"—what a wonderful thing it would be if he literally could "see what's wrong." Who hasn't dreamed of being a technical Superman with X-ray vision—able to spot obscure troubles like that slightly leaky coupling condenser—just by taking a quick look? Fanciful as the dream may be, we can make an effective approach toward it with the cathode-ray oscilloscope.

There are many servicemen who scoff at this exceedingly versatile instrument as being excessively complex and expensive—holding that a simple multimeter can give many of the indications obtainable with the oscilloscope. This shortsighted attitude results only in false economy. The saving of time alone, when the oscilloscope is used for certain troubles where its direct approach cuts clean across deviously roundabout methods, makes it a tool of paramount importance to the efficient technician. In addition, the oscilloscope will supply visual information about the signal that would usually remain a closed book to the repairman using only a voltmeter and his ears as indicators.

As a representative example, let us check a superheterodyne with the typical "All-American" five-tube line-up, illustrated in Fig. 1. The tests are shown in consecutive order in the Table of Test Connections and Wave Patterns, and the screen pattern to look for in each case appears with the table. Since previous RADIO-CRAFT articles have covered the fundamentals of operation

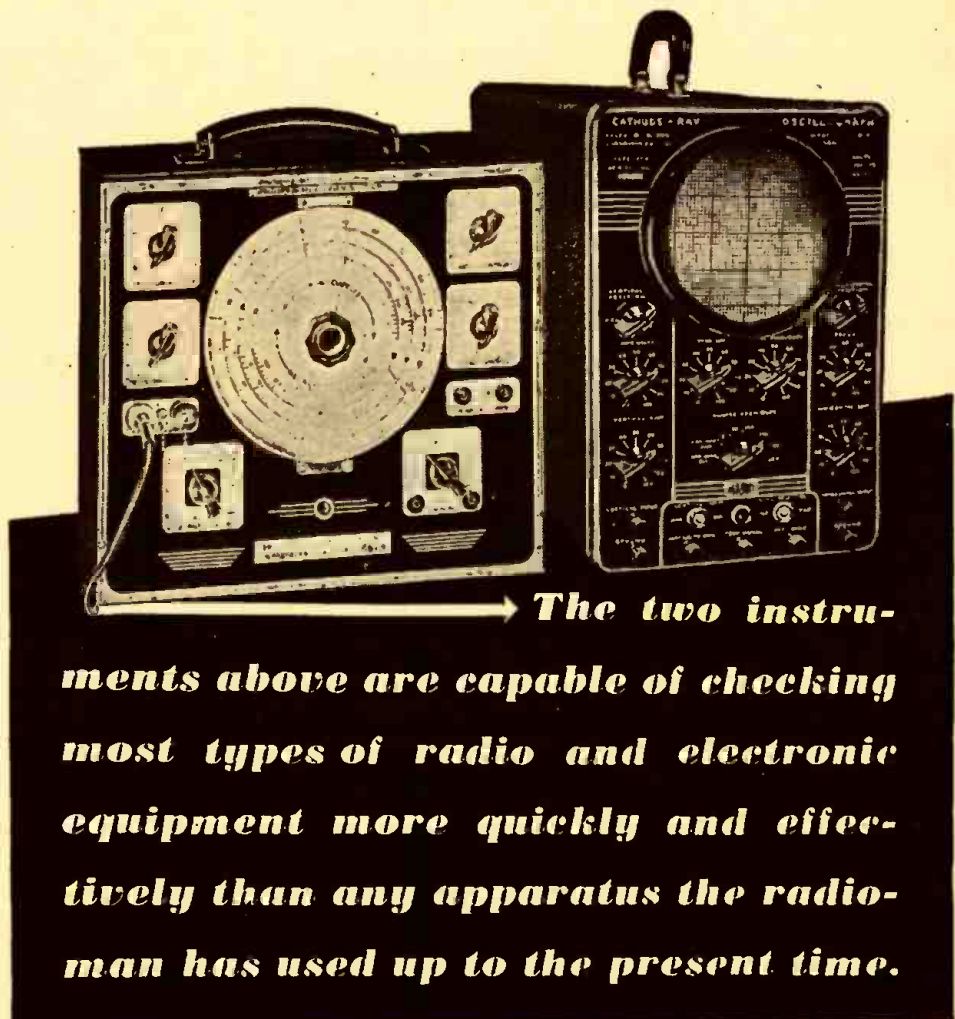

of the oscilloscope, we will start here directly with the receiver power supply. Connections are made as in the Table of

Test Connections and Wave Patterns.

The first three tests determine the condition of various sections of the power supply: First, the power transformer action of alternating-current receivers in furnishing high-voltage 60-cycle a.c. is shown in test No. 1 as indicated in the table; then the pulsating d.c. furnished by the rectifier in test No. 2, and then the filtered output of the power supply sections in test No. 3.

In viewing the pulsating d.c. (test No. 2) it will be recalled that the signal reaches the cathode-ray deflecting plates through an internal coupling condenser (0.25  $\mu$ f), which blocks the steady d.c. voltage, and thus allows the oscilloscope to indicate only the pulsations (a.c. component) of the rectified d.c., also called the ripple voltage. This a.c. component, or ripple voltage, will have a smaller value than the original a.c. from the transformer. To use the ripple voltage as a reference value, the

1: Keillor, *Oscilloscope for Trainees*, July 1945, RADIO-CRAFT.  
2: Prenskey, *The Oscilloscope*, April 1946, RADIO-CRAFT.

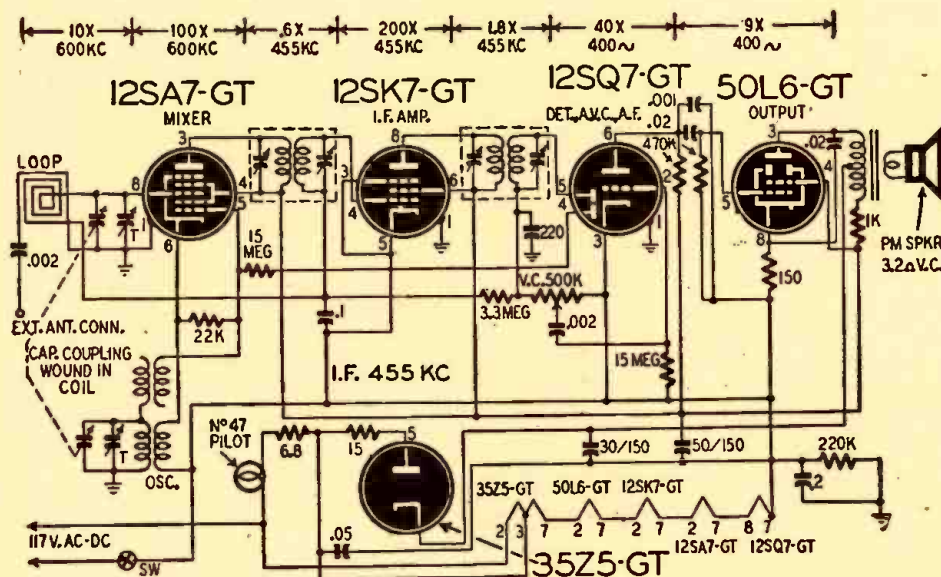

Fig. 1—Standard small radio (Emerson 501 series) used for explaining test procedures.



oscilloscope gain is turned up until the pattern conveniently fills the screen.

When the pattern of the filtered d.c. is next investigated (test No. 3), the ripple voltage should come down to a practically negligible value. Experience will soon make it easy to determine when the hum is negligibly low from the observed pattern, checked by the audible evidence from the loudspeaker. It is a good plan to get experience by first checking a power supply known to be in excellent condition. Thus, sources of hum, such as an open (or dried-out) filter condenser, are quickly located. (It should be noted that a tunable hum

which does not originate in the power supply proper would not show up here, but would be caught later at the place it actually occurs.)

#### QUICK CHECK METHOD







The procedure can be considerably simplified and speeded up by the practice of using a *quick check* point to indicate the general operating picture of an entire section and then moving on to a new section. Whenever such a quick check point indicates possible faulty operation, it is then followed up by a more detailed series of tests. This method is rapid and reduces the complete table of sixteen points (and two ad-

vanced optional tests) to only five test points, which give the first indication for the d.c., a.f., i.f., oscillator, and r.f. sections of the set. The general testing plan is that of working backward with injected signals, jumping from place to place as we select the significant test points of each of the five sections, and then retracing the steps in a more detailed manner in any particular section where faulty operation is suspected.

The quick check point for the power-supply section is obviously test No. 3. If proper operation is indicated here, we proceed to the next quick check point, in the a.f. section.

(Continued on page 136)

### TABLE OF TEST CONNECTIONS AND WAVE PATTERNS

Pattern 1	Pattern 2	Pattern 3	Pattern 4	Patterns 5, 6, 7	Patterns 8, 9
					
INDICATION DESIRED	SCOPE CONNECTIONS TO SET	SCOPE ADJUSTMENT	PATTERN TO BE OBTAINED	INTERPRETATION	
Power Supply Section Test 1 60-cycle a.c. input to rectifiers	Vert. terminals to 35Z5 plate (pin 5), and chassis	Vert. gain turned up to fill screen with 2 complete cycles	60-cycle wave with 30-cycle sweep. (Pattern 1)	A.c. input from power transformer to rectifier; also used as reference.	
Test 2 Half-wave rectified d.c. ripple (unfiltered d.c.)	Vert. term. to 35Z5 cathode (pin 8), and chassis	Observe, then readjust to fill screen with 2 complete cycles	Rectified d.c. ripple. Same 30-cycle sweep. (Pattern 2)	A.c. component of 35Z5 rectifier action; also used as reference	
Quick Check Point Test 3 Filtered d.c. (after filter)	Vert. term. to B+ [at 50L6 screen, (pin 40)], and chassis	No change	Filtered d.c. ripple. Same 30-cycle sweep (Pattern 3)	Negligible filtered d.c. ripple, for entire power supply section	
A.F. Amplifier Section Test 4 Output transformer operation	Scope across voice coil; a.f. gen. signal through 0.05µf blocking condenser to 50L6 plate (pin 3), and chassis	Advance set volume control to operating position and turn up gen. signal for readable pattern on scope	3 complete cycles of 400-cycle wave (Pattern 4)	Output transformer functioning O.K.	
Test 5 Output tube (50L6) operation	Scope unchanged; a.f. gen. signal (high side) shifted to grid of 50L6 (pin 5)	No change	1-stage audio-amplified 400-cycle wave (Pattern 5)	Amplification by 50L6 satisfactory	
Test 6 Coupling Condenser from 12SQ7 plate to 50L6	Scope unchanged; a.f. signal shifted to plate of 12SQ7 (pin 6)	No change	1-stage amplified 400-cycle through coupling C (Pattern 6)	Coupling condenser functioning O.K.	
Test 7 Tone control, if present	Scope and a.f. gen. unchanged	Same— Vary tone control	Attenuation by tone control (Pattern 7)	Tone control functioning O. K.	
Quick Check Point Test 8 Voltage amplification of 1st radio tube (12SQ7 triode)	Scope unchanged; a.f. gen. high side shifted to grid of 12SQ7 (pin 2)	Reduce a.f. gen. signal if necessary	1-stage audio-amplified 400-cycle wave (Pattern 8)	Amplification by 12SQ7 triode satisfactory	
Test 9 Over-all a.f. section, from diode load resistor to voice coil	Scope across voice coil; a.f. (400-cycle) gen. signal through blocking condenser (0.05), to high end of vol. control	Adjust weak a.f. signal to show 3 complete waves, reset vol. control as in normal operation	2-stage amplified 400-cycle signal through coupling condenser (Pattern 9)	Satisfactory operation of entire a.f. portion	



# SIMPLE ELECTRONIC ORGAN

## A Worthwhile Instrument for the Serious Experimenter

WHILE glancing over the May, 1942, issue of RADIO-CRAFT I came upon an article by W. K. Allan entitled "Build Your Own Experimental Electronic Organ." The idea clicked and resulted in an extensive program of experiment and research into patents, to find a system which would be both practical and economical, yet versatile enough to produce a variety of tone colors with a variable wave envelope.

repeated ad infinitum. Vacuum-tube-transformer oscillators, in the author's experience, are fairly stable, and they generate notes of reasonably good tone quality. However, to generate the 61 tones (or 96 with pedals and complete harmonic coupling) necessary for the range of an organ, we must have 61 vacuum tubes and 61 audio transformers, which represent quite an outlay for the tone-producing mechanism alone, much more than the average en-

sible to keep an isolated neon oscillator in tune.

It would seem desirable to turn this instability into a useful asset. The author has found this can be done by stabilizing each set (all C's, all C's, etc.) with a master oscillator of the transformer type tuned to a harmonic of the set (group of oscillators in harmonic relation), thus securing both inexpensiveness and stability. This is possible because of the tendency of the relaxation oscillators to lock in at some simple ratio of the controlling frequency of the master oscillator, the action being analogous to that of a multivibrator. Twelve master oscillators are tuned to the notes in the highest octave of the keyboard, with each producing the synchronizing voltage for the four or five relaxation oscillators of the set, as shown in Fig. 2. It was found that when the master oscillator is in operation, each relaxation oscillator will oscillate only at a note which is an integral number of octaves lower than the master oscillator (or occasionally at a fifth between octaves, since fifths are also in very close harmonic relationship).

C#50 1108.7	D 51 1174.7	D#52 1244.5	E 53 1318.5	F 54 1396.9	F#55 1480.	G 56 1568.	A <sup>b</sup> 57 1661.2	A 58 1760.	B <sup>b</sup> 59 1864.7	B 60 1975.5	C 61 2093.
C#38 554.4	D 39 587.3	D#40 622.3	E 41 659.3	F 42 698.5	F#43 740.	G 44 784.	A <sup>b</sup> 45 830.6	A 46 880.	B <sup>b</sup> 47 932.3	B 48 987.8	C 49 1046.5
C#26 277.2	D 27 293.6	D#28 311.1	E 29 328.6	F 30 349.2	F#31 370.	G 32 392.	A <sup>b</sup> 33 415.3	A 34 440.	B <sup>b</sup> 35 466.2	B 36 493.9	C 37 523.3
C#14 138.6	D 15 146.8	D#16 155.8	E 17 164.8	F 18 174.6	F#19 185.	G 20 196.	A <sup>b</sup> 21 207.7	A 22 220.	B <sup>b</sup> 23 233.	B 24 246.9	C 25 261.6
C#2 69.3	D 3 73.4	D#4 77.8	E 5 82.4	F 6 87.3	F#7 92.5	G 8 98.	A <sup>b</sup> 9 103.8	A 10 110.	B <sup>b</sup> 11 116.5	B 12 123.5	C 13 130.8
											C 1 65.4

The complete oscillator system. Top row of tubes are half-6N7's, others neon-tube oscillators.

The result was the construction of the instrument described here. While it is superficially similar to Mr. Allan's organ, it nevertheless has a great many features borrowed from each of several other electronic musical instruments, notably the Hammond Novachord, and one developed by N. Langer, together with a few innovations which are believed to be original.

enthusiast would care to spend.

The other audio oscillator useful for electronic music is known as a neon bulb relaxation type. It operates as follows (see Fig. 1): A d.c. potential is applied to terminals A and B, so that current flows through R1 and gradually charges capacitor C. The neon ionizes and becomes a conductor only when the potential across C builds up to a certain definite value, about 90 volts. At that point the neon bulb suddenly discharges C, through R2, bringing the potential of C down to a very low value, at which the neon no longer conducts. The capacitor begins to recharge, and the process repeats itself once more. The frequency generated is approximately proportional to the voltage applied at AB and inversely proportional to the values of C and R1. R2 affects the frequency but slightly; its purpose is to control the harmonic content and to prevent a harsh tone from being developed.

The cost of a typical relaxation oscillator is, of course, far less than one of the vacuum-tube-transformer type, its tone is richer in harmonics; and there are no tube filaments to light. But it suffers from a very serious disadvantage. Slight changes in the supply voltage or in the spacing of the electrodes in the neon bulb have a marked effect on the pitch; it is next to impos-

The particular octave at which an individual relaxation oscillator will work, given a fixed master frequency, depends on the choice of circuit constants for that relaxation oscillator. Therefore the procedure for tuning a typical set such as that shown in Fig. 2 is:

1. Adjust the master oscillator to a note which is near what the highest note in the set will eventually be. This is done by removing laminations in the core of the audio transformer and by adjusting the variable mica trimmer C5. In the case of the C set, for example, the master oscillator is tuned to note C61, the highest note in the keyboard, which has a frequency of 2,093 cycles per second.

2. Adjust each of the neon oscillators of the set in turn, starting with that for note C49, an octave lower (1,046.5 cycles) by varying the trimming capacitor for that oscillator until it locks in at the right octave. It may also be necessary to vary the value of R5 and to exchange neon bulbs to get a particular neon oscillator to work at the note desired.

The condenser and resistor values are approximate only. Much depends on the particular neon tubes in a given circuit. Thus experimenting with condenser and resistor values and changing neon tubes is required to get the desired results.

For the same reason, as well as the impossibility of reproducing in RADIO-

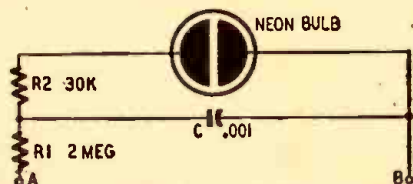

Fig. 1—A neon-tube relaxation oscillator.

A musical tone may be produced electronically in many different ways. All these employ either the electron-tube oscillator or some mechanical device such as a tuning fork, reed, stretched string, or rotating tone wheel. It was decided to stick to purely electronic means of tone generation and control.

Audio oscillators use one of two basic principles of operation. The conventional vacuum-tube-transformer type depends on feeding back some of the plate-circuit oscillations through an audio transformer to the grid circuit, where they are amplified; and the process is



CRAFT the enormous diagram that would be required, circuit constants of only the C set are given, from which resistor and condenser values for the other sets can be intelligently inferred.

(3) After the relaxation oscillators have been adjusted, the master oscillator probably will have changed slightly in pitch and should be retuned perfectly by means of the variable resistor marked TUNING. If the system is operating correctly, all the neon oscillators in the set will remain in synchronization with the master and all will be tuned by that control. This arrangement makes it necessary to tune only the twelve notes in the top octave before each use; the complete keyboard is then automatically tuned.

These tuning processes may be accomplished with the aid of a calibrated audio oscillator, but if one has any sort of musical ear, better results will be obtained by using the method employed by professional piano tuners—counting beats between intervals.\* It is of highest importance to have the voltage of the B-supply determined before tuning is commenced, because any change in voltage has a profound effect on pitch. The author found three heavy-duty 45-volt B-batteries connected in series to be the most satisfactory as a constant-voltage supply.

#### ENVELOPE CONTROL

If only organ effects were desired, the system described so far would be quite sufficient for the framework of the instrument. However, it is possible (as in the *Novachord*) to control completely the wave envelope of the audio tone, to vary the speed with which the notes build up and die away in such a manner as to be able to imitate successfully a plucked harp or guitar string, chimes or violin, and to produce new and very beautiful effects. The instrument has provision for controlling the "attack" and "decay," in the form of an electron-tube keying circuit to link each oscillator to the amplifier, as shown in Fig. 3.

Since the key contacts are normally open, C1 becomes charged through R1 and R3 to a high value, and this places the grid of the keying tube at a high negative potential relative to the cathode, and thus prevents any signal from getting through the tube to the amplifier. When the key is depressed, however, C1 discharges through the variable attack control R2 at a rate determined by the value of its resistance, and the grid is gradually brought back up above cut-off. The intensity of the tone therefore increases from zero to full at a rate which may be made almost instantaneous if R2 is made small enough. When the pressure on the key is released, C1 is gradually recharged through R1 at a rate determined by the setting of the decay control R3, and the tone slowly dies away to nothing. With

the right mixture of harmonics (discussed later), a very short attack, and a very long decay, for example, one can produce a tone which sounds exactly like a plucked guitar string. A very long attack could simulate a violin or perhaps a musical saw, depending on the harmonics.

The keyboard was that of a discarded piano. A contact made from a small bent strip of sheet metal was fitted underneath the front of each key so that it would complete the circuit by touching the bus. This proved satisfactory except for the key clicks which occurred every time the circuit was opened. The clicks were finally eliminated by covering the bus with several strips of graphite-impregnated cloth made by rubbing the cloth with a soft lead pencil. The resistance contacts proved to have a high enough conductivity to discharge the bias-storing capacitors as originally planned, and in addition had the effect of making the note slightly louder when its key was pressed more heavily, thus making it possible to accentuate the melody note at will. This effect is highly desirable, for it at least partly eliminates the necessity of having two manuals, one for melody and a softer one for accompaniment.

#### THE COUPLERS

To add other tones to the fundamental note, the instrument must have harmonic couplers. It is practically indispensable, if one desires any variety of tone color, to be able to mix fundamental, sub-fundamental, second harmonic, and third harmonic, corresponding to the 8', 16', 4' and 2 2/3' organ stops, respectively. For example, when C25 is depressed, these notes would be C13, C25, C37, and G44. The coupling action is accomplished by having four 61-pole single-throw switches, one for each component to be added, as shown in Fig. 4 and the photo. Each

consists of a wooden cylinder, 1 inch in diameter and about 2 feet long, with two rows of 61 brushes each, one row on each side of the cylinder. A control mounted on the front of the console rotates the cylinder enough to bring a set of contacts mounted on it into such a position that they connect each brush in one row with the one opposite in the

other row. In view of the great amount of labor involved in constructing these couplers, the author strongly advises anyone interested in the project to make a serious attempt to procure them sec-

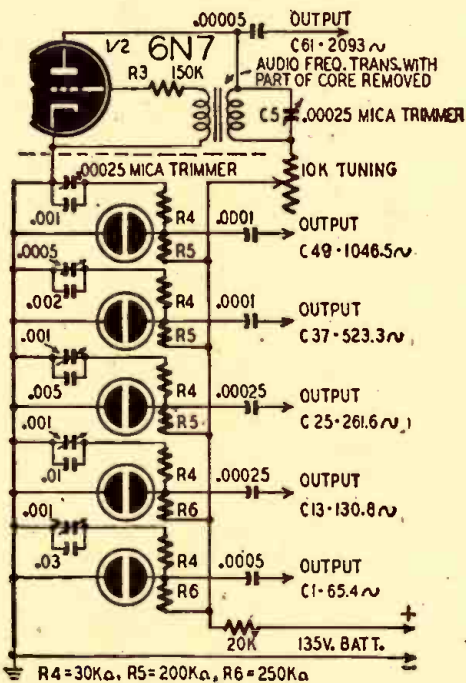

Fig. 2—Typical set of harmonic oscillators.

ondhand (and a standard organ manual as well) rather than construct them himself.

In addition to the main contact un-

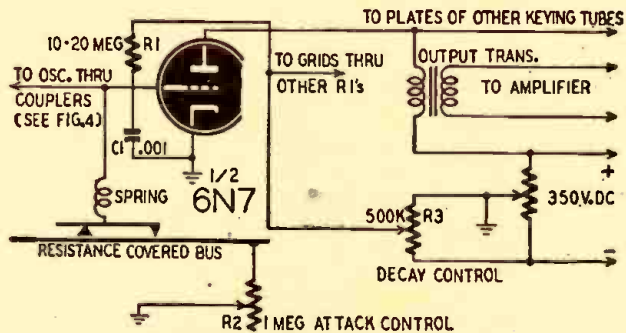
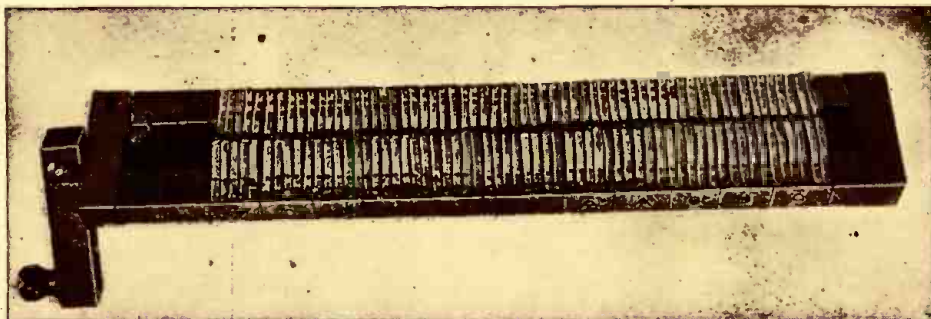

Fig. 3—Half 6N7's are used in the 61 keying circuits.

derneath the front of each key, as previously mentioned, there must be a four-into-one contact on the back of the upper surface of each key to provide for feeding the harmonics selected by the couplers into the keying control for that particular key. This contact is made by mounting four spring-wires above the

(Continued on page 113)



One of the four hand-made couplers used in the organ. It is a 61-pole, single-throw switch.

\* Readers who are more familiar with electronics and music may be interested in some material on tuning a musical instrument. Standard works are: William Braid White, *Piano Tuning and Allied Arts*, fourth edition, 1943. John Redfield, *Music, Science and Art*.



# ANTENNA PRINCIPLES

## Part II—Multi-Element, Long-Line and Rhombic Antennas

THE half-wave dipole antenna is the basis for practically all other types. As used here, the term "half-wave" refers to an electrical half-wave, not the physical length. It is the distance which a wave can travel in empty space in the time required for half of a complete cycle. In space, a half-wave is conveniently calculated from the equation:

$$\frac{\lambda \text{ (meters)}}{2} = \frac{300}{2 \text{ mc}}$$

where 300 is the velocity (in millions of meters) of light and radio waves. The velocity of a wave is less along a solid conductor than it is in space, and along a conductor of large diameter or cross-section, it is less than on a thin wire. In many cases the actual *physical* length must be found by experiment. The velocity of propagation along coaxial cables is often specified by the manufacturer. Inserting this information into the above equation (instead of 300) the physical half-wave may be determined.

The length of an antenna made of No. 12 or 14 wire will be approximately 95 percent of that indicated above. Typical antenna lengths are listed below:

Freq. (mc.)	Half-wave (ft.)
3.5	133
7.0	67
14.0	33.5
28.0	16.6
60.0	7.7
144.0	3.2

### MULTI-ELEMENT ARRAYS

The simple dipole can be improved upon by using elements in combination so that each adds to the effectiveness of the others. In combining elements they must be driven in *proper phase* so that

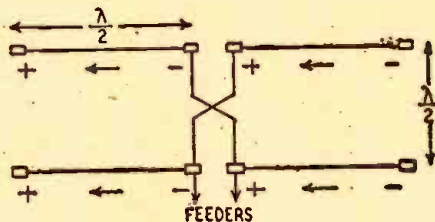

Fig. 1—A simple array, the Lazy-H antenna.

power is strengthened in the desired direction and weakened or cancelled out in other directions. As a result the same power fed into the array will give a tremendous increase in sensitivity in a given direction, and at the same time will cut down interference caused by radiating power where it is not needed. Conversely, as a receiving antenna, sensitivity is decreased from directions from which no signals are desired. If the entire array can be made to rotate, any direction may be chosen as the one of maximum sensitivity.

A common array is shown in Fig. 1. This illustrates the principles of phasing each antenna so that radiation is strengthened in the desired direction and cancelled out in others. It consists of four half-wave antennae, two of them forming a straight line a half wavelength above the other pair. The feeders may (or may not) be of the resonant type. Polarity signs are drawn for a particular instant of time. It is evident from the figure that they are fed *in phase*, that is, current (shown by arrows) in each flows in the *same* direction at every instant. This pair acts just like a single antenna twice as long as the usual dipole, and therefore gives and receives a stronger signal at right angles to its length.

Since the upper antenna is an electrical half-wavelength above the lower

wire the polarity along the feeder is reversed, but since the feeder is also *transposed*, the polarity at corresponding points is the same as that along the lower wire. As a consequence, radiation is greatly increased (a power gain of about four) broadside or at right angles to the plans of the antenna, that is, in and out of the page. On the other hand, waves traveling up or down are cancelled out. Assume, for example, that the lower wire radiates a positive wave at a particular instant. It reaches the upper wire just in time to combine with the negative wave which the latter transmits at that time. The two cancel completely. This antenna array is an example of a *driven* system, that is, one in which each element is supplied with power from the feeder system.

Power may be strengthened in desired directions by elements which are not connected to the feeders. These elements are known as *parasitic*. They are designed to pick up power from the actual driven or radiating element, and to transmit it in the proper phase so that the resulting wave is either weaker or stronger, as desired. In the first case, the element is a reflector and is placed behind the radiator. In the second case, the element is a *director*, built in front of the radiator.

Parasitic elements are much more

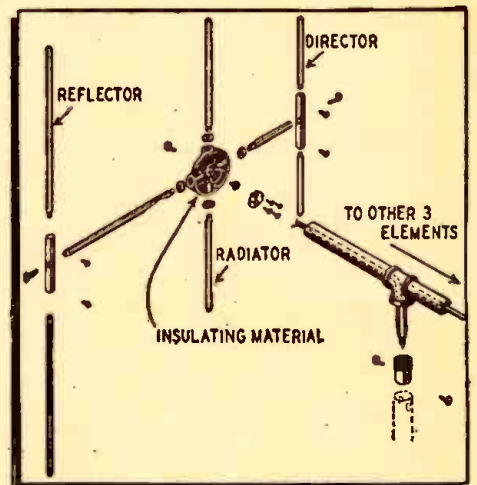
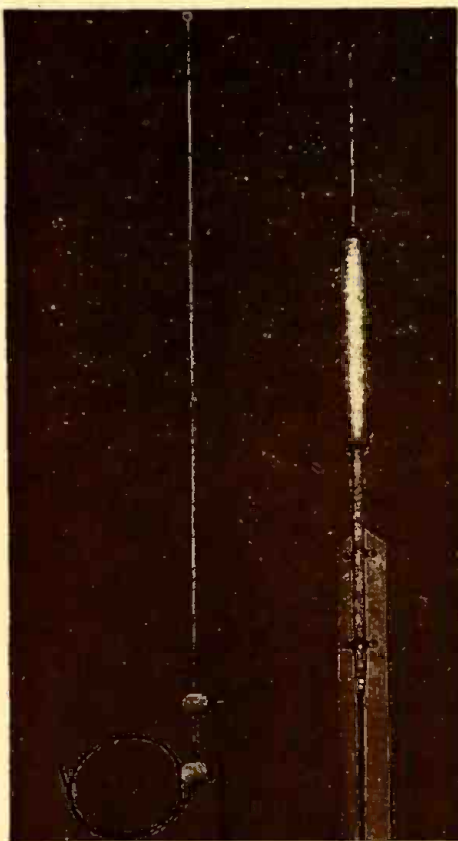

Fig. 2—Construction of six-element antenna.

convenient to construct both from the standpoint of physical design and feeding problems. If the distance between elements and the length of the parasitic elements can be adjusted, optimum results may be obtained by actual experiment.

In general, the reflector is longer  
(Continued on page 121)



Courtesy Engineering Electronics and the Andrew Co.

Two types of co-axial antennas. The two illustrated resonate at approximately 2 meters.





Our fondest greetings and heartfelt thanks to "The Father of Radio" on the occasion of this fortieth anniversary of his epoch-making Audion.

# COMPLETE COMPACT and INEXPENSIVE!



**SUPREME TRANSMITTER Model AF-100, 6-Band, 100 Watt (output) Desk Type Transmitter.** Embodies ALL the features most desired by the majority of the amateurs. Designed to cover the amateur bands most frequently used: 10, 11, 15, 20, 40 and 80 meters for CW, ICW, AM and FM Phone transmission. This is the very first transmitter offered to the amateur which has the new feature of Frequency Modulation in the band of frequencies assigned for this purpose, namely 27.185 to 27.455 and 29 to 29.7 megacycles. Model AF-100 is continuously tunable throughout the range of each of the amateur bands. A highly stable variable oscillator followed by slug-tuned buffer and doubler stages which are ganged to the oscillator dial simplifies the problem of working through

severe QRM and further enhances the pleasures of easily establishing and retaining QSOs. Band changing is easily accomplished in the exciter by a band selector switch and in the final by the plugging in of a coil for the particular band selected. This unit is one of the simplest to operate—and highly efficient on all bands, for all types of emission.

**Front Panel Controls:** Oscillator Dial; Final Amplifier Dial; Oscillator Selector Dial; Modulation Selector Dial; Microphone Gain Control; Band Selector Switch; Filament Power Switch; Plate Power Switch; Emission Selector Switch; Standby Control. **Metering:** PA Plate Current; PA Grid Current; Modulator Plate Current.

Type	TUBE COMPLEMENT
1—6AC7	Reactance Tube Modulator
1—6J5	Variable Frequency Oscillator
1—6AC7	Class "A" Amplifier or Crystal Oscillator
1—6L6	80 meter Tripler or 40 meter Doubler
1—6L6	20 meter Doubler
1—6L6	15 meter Doubler
1—3D23	10 meter Doubler
2—807	Final Amplifier
1—6J5	Class AB <sub>2</sub> Modulators
1—6SJ7	Modulator Driver
2—866A	Speech Amplifier
1—5R4GY	High Voltage Rectifiers
1—5R4GY	Low Voltage Rectifier
1—80	Modulator Rectifier
1—6X5GT	Speech Rectifier
1—VR 150	Bias Rectifier
1—6SN7GT	Voltage Regulator
	Audio Oscillator

**Frequency Range:** 10, 11, 15, 20, 40, 80 meters  
**Output Power:** 100 watts on CW, ICW and Frequency Modulation

**Method of Modulation:** AM—High Level Class AB<sub>2</sub>; FM—Reactance Tube Modulation

**Modulation Capabilities:** AM—100%  
FM—100% = ± 75 kilocycles (variable from .075 kc.)

**Input Audio Source:** High Impedance Crystal or Dynamic Microphone, Level 60 DB down

**Audio Frequency Response:** AM—± 2DB, 200 to 6000 cps  
FM—± 1DB, 100 to 7500 cps

**Noise Levels:** AM—Minus 45DB below 100% modulation  
FM—Minus 60DB below 100% modulation (± 75 kilocycles)

**Audio Frequency Distortion:** AM—5% at 85% modulation for 100 watt output  
FM—1.5% at 100% modulation

**Frequency Control Elements:** Stabilized Variable Frequency Oscillator or two (2) crystal controlled positions.

## ELECTRICAL CHARACTERISTICS

Amateur Bands—10, 11, 15, 20, 40, 80 meters  
100 watts on CW, ICW and Frequency Modulation  
100 watts Amplitude Modulation

AM—High Level Class AB<sub>2</sub>  
FM—Reactance Tube Modulation

AM—100%  
FM—100% = ± 75 kilocycles (variable from .075 kc.)  
High Impedance Crystal or Dynamic Microphone, Level 60 DB down

AM—± 2DB, 200 to 6000 cps  
FM—± 1DB, 100 to 7500 cps  
AM—Minus 45DB below 100% modulation  
FM—Minus 60DB below 100% modulation (± 75 kilocycles)

AM—5% at 85% modulation for 100 watt output  
FM—1.5% at 100% modulation  
Stabilized Variable Frequency Oscillator or two (2) crystal controlled positions.

And here are some more details . . .

Dimensions: 29 3/8" long; 11 3/4" wide; 18 3/8" deep.

Power Source: 110-117 v. 50/60 cycles.

Power Consumption: 325 watts.

Approximate Weight: 125 lbs.

Comes complete—only items required to "get on the air" are key, mike and two crystals.

Inexpensive—a wonderful value at \$450 — including tubes and coils!

**SUPREME TRANSMITTER CORPORATION**  
280 NINTH AVENUE  
NEW YORK 1, N. Y.





# Build a Television



Instructor demonstrating rare Schmitt Optical System, used in big picture, projection type, television receivers. This famous television school's location in the heart of the television industry, helps it to get such scarce scientific equipment. At N.Y.T.I. of N.J. all types of television receivers are available for student study.

To stimulate its radio and television training programs, this famous resident radio and television school is offering men interested in television this unusual opportunity.

If you are unable to leave home to go to a resident school, N.Y.T.I. of N.J. can supply you with parts to build a television chassis in your own home. You will be supplied with the same instructions and directions with which the school's resident students are equipped, when they reach the stage in their training that calls for television set construction. If you already have a sound radio background, with experience in building radio receivers, you will be surprised to find how much you can learn about television by building this set.

N.Y.T.I. of N.J. is one of America's leading resident schools for men seeking dependable, thorough, up-to-the-minute training in the various fields of radio and television.

The schooling offered by N.Y.T.I. of N.J. is particularly useful to those who recognize the high-earning possibilities of technical training in radio and television and are willing to tackle the class and laboratory work offered, regardless of their previous education.

No high-school diplomas are needed for entrance. But N.Y.T.I. of N.J. requires that a student be earnest, sincere, and radio-minded. Students without proper mathematical backgrounds are taught the radio and



You can build a direct viewing television chassis similar to the one pictured above, either in your own home or in the magnificently equipped shops and laboratories of this famous television

school, located square in the HEART of America's television manufacturing and broadcasting industry. Mail the coupon at the right to get full details.



# Set Right in Your Own Home!

television mathematics they need. Several students with only grammar school educations have successfully completed advanced technical television courses.

A considerable number of out-of-state students attend the school because of its excellent, practical type of radio and television courses, so difficult to get anywhere else in the world today. Living quarters are obtainable by single students.

## You Put Into Practice Everything You Learn

Students at N.Y.T.I. of N.J. particularly like the way the school puts into practice what it teaches. You may actually build a 17-tube television chassis. You also help build as many as 7 radio receivers of different types, a total of 75 electronic educational devices. Class study, and laboratory study, in the proper combination, increase interest—and your hands get as smart as your head.

A 17-tube, experimental, television chassis may be built by all resident students of television, and may be kept as their own property, if they so choose.

## Located in the Heart of the Electronic Industry

The New York Technical Institute of New Jersey is in Newark, N. J., just across the river from New York City (only 20 minutes from Broadway by subway or train). The school is located in the heart of America's great radio and electronics industry. Such leading television, radio and electronics manufacturers as R.C.A., Western Electric, Du Mont, Federal and Edison are nearby. This means that the school offers numerous advantages, as it is in touch with the most recent developments in radio and television.

Highly qualified television and radio instructors are here in abundance. Equipment is easier to get. Television students are offered exceptional advantages in this great electronic center.

**MAIL THE COUPON  
TO GET FULL  
INFORMATION . . . FREE**

The school issues a special Bulletin which illustrates and describes its truly exceptional facilities and equipment. This Bulletin also describes classes that may be attended, housing conditions, costs, hours, etc. If you are interested in Television—you will want to read this Bulletin. You can have it *free*, merely by mailing the coupon at right.

The school will also be happy to send you complete information about the television kits and directions which are now available to you if you desire to build your own television chassis at home.

Just fill out the coupon at right and mail it NOW to: *New York Technical Institute of New Jersey, Dept. 41, 158 Market Street, Newark, N. J.*



Instructor demonstrating theory of light in connection with study of optical systems used in projection type television receivers. This is just another one of the pieces of equipment which the New York Technical Institute of N.J. has available for resident student instruction.



Big picture television (16" x 21 1/4") in the flesh at N.Y.T.I. of N.J. When it comes to television receivers, N.Y.T.I. of N.J. has it! All types of television receivers are available for student use and instruction at the school.

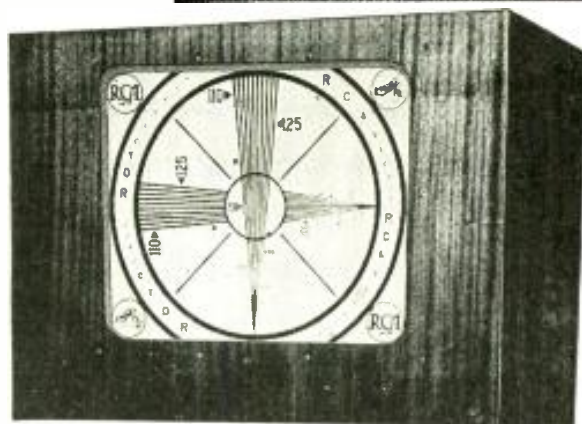

Standard laboratory type test pattern used for determining picture perfection in all types of television transmitters and receivers. (You can see it at N.Y.T.I. of N.J.)

**New York Technical Institute of New Jersey, Dept. 41,  
158 Market Street, Newark, New Jersey**

Check here if you wish to receive the Special FREE Bulletin describing the resident school of the New York Technical Institute of New Jersey located in Newark, N. J.—including its facilities, equipment, courses offered, costs, hours, etc.

Check here if you wish complete information about building a television chassis in your own home.

Check here if you are a War Veteran.

Name.....Age.....

Address.....

City.....Zone (if any).....State.....





*Drop-wire undergoing abrasion tests in birch thicket "laboratory." Below, the new drop-wire, now being installed.*

## WE'RE GLAD THAT BIRCH TREES SWAY

The telephone wire which runs from the pole in the street to your house is your vital link with the Bell System. More than 17,000,000 such wires are in use.

The wire becomes coated with ice; it is ripped by gales, baked by sun, tugged at by small boys' kite strings. Yet Bell Laboratories research on every material that goes into a drop-wire—metals, rubbers, cottons, chemicals—keeps it strong, cheap, and ready to face all weathers.

Now a new drop-wire has been developed by the Laboratories which lasts even longer and will give even better service.

It has met many tests, over 6 or 7 years, in the laboratory and in field experiments. It has been strung through birch thickets—rubbed, winters and summers, against trees, and blown to and fro by winds. In such tests its tough cover lasts twice as long as that of previous wires.

House by house, country-wide, the new wire is going into use. Wire is only one of millions of parts in the Bell System: All are constantly under study by Bell Telephone Laboratories, the largest industrial laboratory in the world, to improve your telephone service.

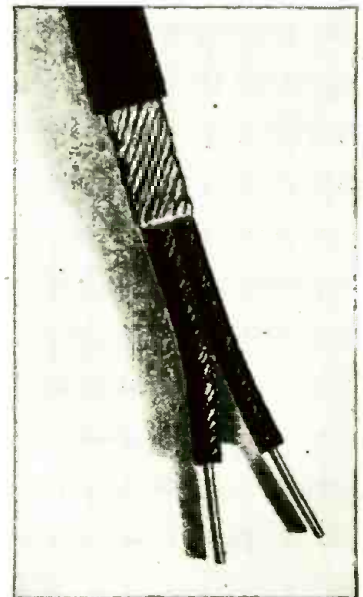

### BELL TELEPHONE LABORATORIES



EXPLORING, INVENTING, DEVISING AND PERFECTING FOR CONTINUED IMPROVEMENTS AND ECONOMIES IN TELEPHONE SERVICE



# Model 2450

## ELECTRONIC TESTER

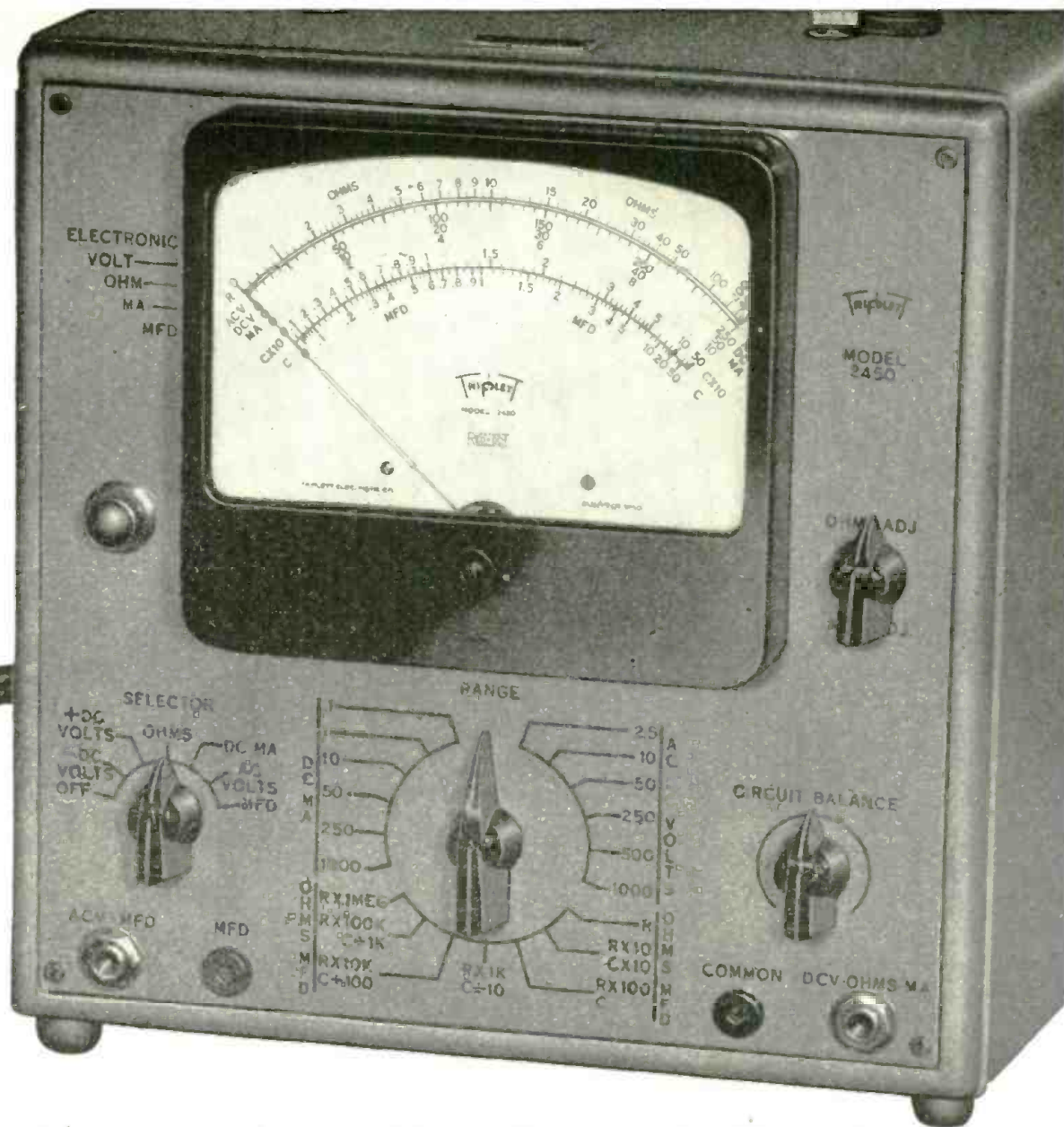

### There's never been a tester like this!

Here's a tester with dual voltage regulation of the power supply DC output (positive and negative), with line variation from 90 to 130 volts. That means calibration that stays "on the nose"! That means *broader service* from a tester that looks as good as the vastly improved service it provides. And, together with its many other new features—including our Hi-Precision Resistor which outmodes older types—it means higher performance levels wherever a tester is needed. Detailed catalog sheets on request.

#### Highlights:

- 42 RANGES: DC and AC. Volts: 0-2.5-10-50-250-500-1000. DC MILLIAMPS: 0-0.1-1.0-10-50-250-1000. OHMS: 0-1000-10,000-100,000. MEGOHMS: 0-1-10-100-1000. CAPACITY IN MFD: 0-.005-.05-.5-5-50.
- LOAD IMPEDANCE: 51 megohms on DC Volts.
- CIRCUIT LOADING: Low frequencies. Circuit loading equal to 8 megohms shunted by 35 mmfd. High frequency circuit loading equal to 8 megohms shunted by 5 mmfd.



# Triplet

ELECTRICAL INSTRUMENT CO. BLUFFTON, OHIO





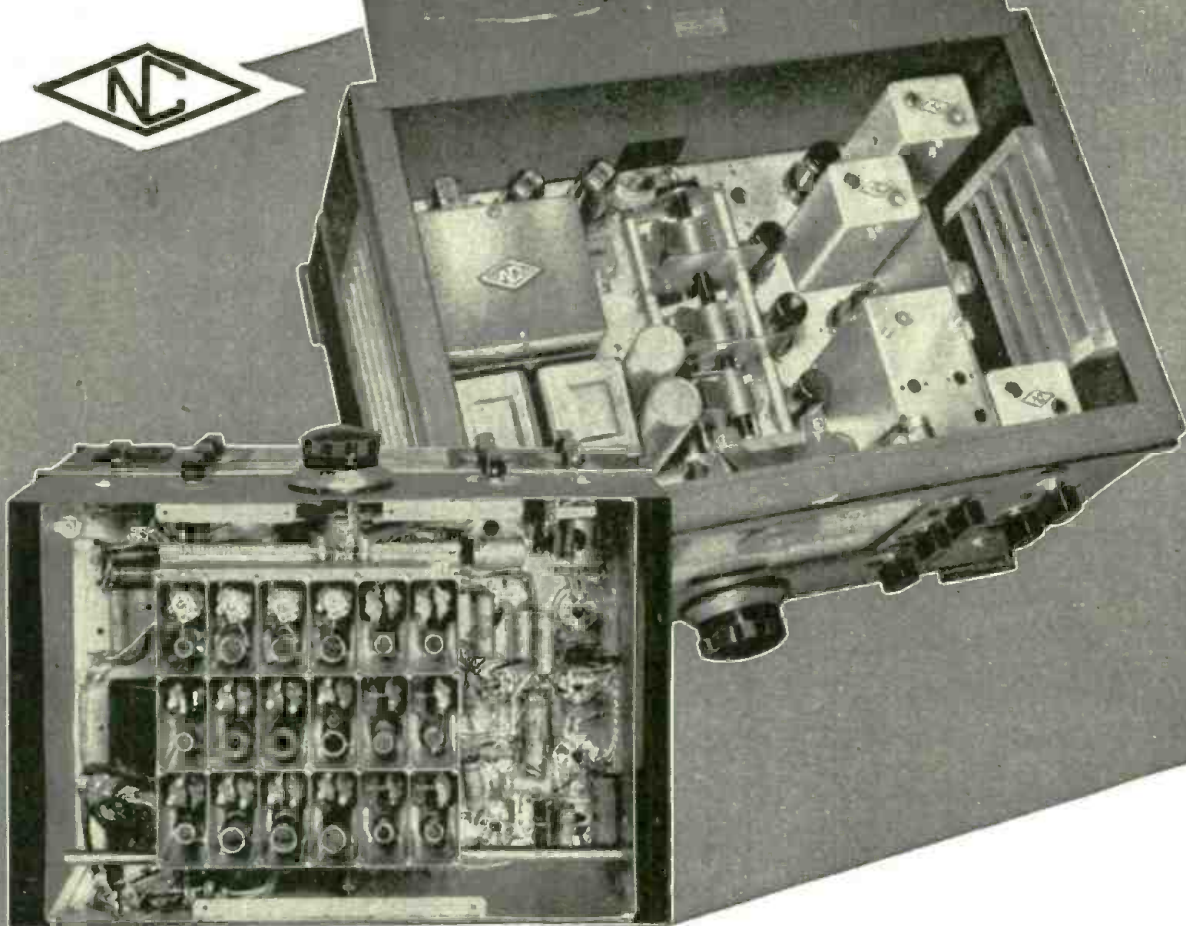

## NC-2-40D

Beauty goes deep in the NC-2-40D. Deep inside the chassis parts of watchlike precision are assembled with painstaking care. Carefully designed mechanisms enable the controls to respond to your slightest touch. Thorough shielding helps circuits to develop the fine performance, stable operation and uniform response that you expect of a National receiver. We invite you to study the photographs above. They are pictures of quality.

**NATIONAL COMPANY, INC., MALDEN, MASS.**



We salute you  
Dr. Lee de Forest,  
on the  
40th Anniversary  
of the  
Invention of your  
vacuum tube.

1907-1947



**JUST OFF  
THE PRESS**

# RADIOMAN'S HANDBOOK

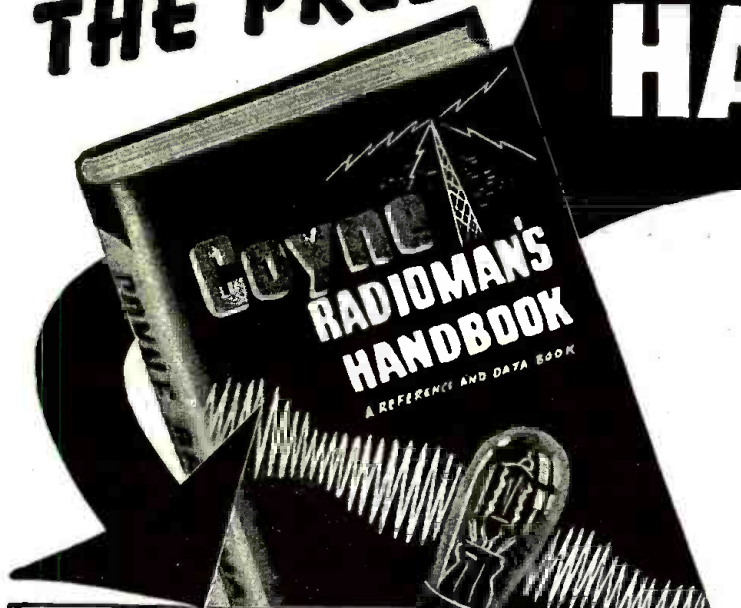

## WHAT THIS GREAT BOOK CONTAINS

Radio Materials	Radio Resistance & Insulation (wire tables, etc.)
Radio Abbreviations	Capacitors & Capacitance
Radio Circuits	Coils & Coil Winding
Power Formulas	Resonance & Coupling
Radio Receiving Tubes	Power Supply—A.C. or D.C.
Reactance & Energy Losses	Power Supply—Batteries
Radio Transformers	Oscillators & Antennas
Radio Amplifiers	Meters & Measurements
Radio Receivers	
Sound Systems & Devices	
Radio Symbols	

**\$ 2.75**

## SEND NO MONEY SEE THIS BOOK FREE

I am not asking you to send any money—not a single penny. I am so sure this is the book you want and need that I will send it to you to examine for 7 days FREE. Then you look it over and you decide. If it isn't all I claim, then send it back and you owe nothing. If you are convinced that this book is worth many times its cost, then send \$3.25 at the end of 7 days and the book is yours. Send the coupon now, while it is before you!

SEE OTHER COYNE BOOKS IN COUPON

**COYNE ELECTRICAL SCHOOL**  
500 SOUTH PAULINA ST.  
DEPT. 17-T6 CHICAGO, ILL.

## A Brand New, Valuable Reference Book for Men Working in Radio or Electronics

This is the book that radio men everywhere have been waiting for. No matter what work you do in radio, this reference handbook will prove mighty valuable since it contains exactly the information you need. You can refer to it easily right on the job. It should help you get jobs done quicker and better—it will save you valuable time. I'm so sure that you wouldn't part with this book for many times its cost that I'm willing to send it to you for a 7 day FREE examination.

### 7 DAYS' FREE EXAMINATION

You can't expect to carry all the necessary information you need on a job in your head. But with this book at your side you will be able to make quick calculations that will help to show the boss that you certainly know plenty about radio construction, design, installation and operation. As you look through the pages of this valuable Radio Handbook you can easily see how the tables, charts, diagrams and information can help you get more money for your services. So I want you to examine this fine book at ABSOLUTELY NO COST TO YOU before you make up your mind whether or not you want it.

### A PRACTICAL REFERENCE BOOK—NOT A TEXT BOOK

You won't need to "study" this book—it is not a textbook. Every subject is indexed and condensed. It is full of valuable tables that will help you in your daily work. When you are "on a spot" just turn to the quick reference index, look up the subject you want and you'll find it thoroughly explained with helpful diagrams and tables. You lose no time. You waste no effort. The book is a day-by-day helper to you and will be of value to you on every job you undertake. It was written by competent, experienced, practical radio engineers and instructors. Every diagram has been fully tested in the great Coyne Electrical Shops. Every table is scientifically correct.

## FREE TRIAL COUPON

B. W. Cooke, Director, COYNE ELECTRICAL SCHOOL, Dept. 17-T6  
500 S. Paulina Street, Chicago 12, Illinois

Send me the COYNE RADIOMAN'S HANDBOOK for 7 days' FREE examination. After 7 days I'll either return the book and owe nothing or I'll send you a check or money order for \$2.75.



Here are other Coyne Books—I'll send any or all on same 7 day Free Examination Offer.

- Coyne Applied Practical Electricity—7 volume set; a complete library on everything electrical in easy to understand form. \$19.75 cash or \$21.00 on time—\$3.00 after 7 days and \$3.00 per month—1 year FREE Consultation Service and Technical Bulletins.
- Coyne Electrical & Radio Trouble Shooting Manual—612 pages, over 500 wiring diagrams, hookups. Radio, P. A. systems, radio testing, refrigeration, motors and controls. \$8.00 cash—\$8.95 on time—\$3.00 after 7 days and \$3.00 monthly—1 year Technical Bulletins Free.
- Coyne Electrician's Handbook—400 pages: data, diagrams, circuits, installation, wiring methods, etc. \$2.75 after 7 days.
- Coyne Electronics for Radiomen & Electricians—over 400 pages: clearly explains all types electronic tubes, hundreds of diagrams, etc. \$3.75 after 7 days' examination—1 year Free Technical Bulletins.
- Electrical & Radio Dictionary and Data Book—3300 electrical and radio, radar, electronic and atomic energy terms, 300 pages, vest Pocket size. \$1.00 after 7 days.

Name .....

Address .....

Town ..... Zone ..... State .....

Where Employed? .....

If you prefer to pay postman cash price indicated above when books arrive check here. Same 7 day examination and money-back guarantee of satisfaction.



**NEW!**

# Proportional Mutual Conductance Tubechecker and Circuit Analyzer

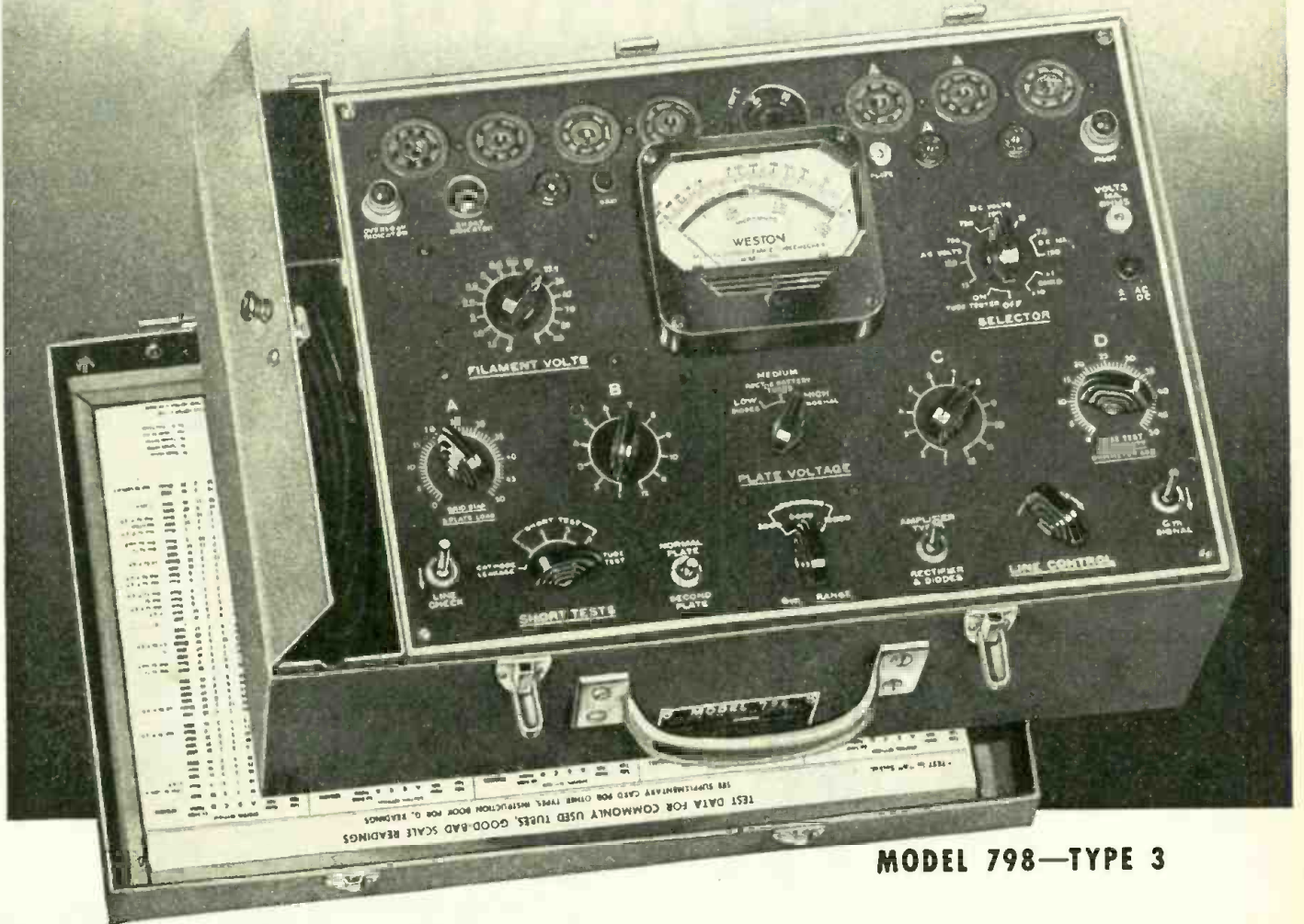

**MODEL 798—TYPE 3**

*Outstanding Features*

- ✓ Direct-reading proportional mutual conductance tests, "Good-Bad" indications.
- ✓ New patented high frequency tube testing circuit.
- ✓ AC-DC volt-ohm-milliamperere ranges.
- ✓ Tests 4, 5, 6, 7 prong octal, loctal, miniature, and acorn tubes... spare octal and miniature sockets.
- ✓ Hot neon leakage test between any two tube elements... neon short check.

- ✓ Adjustable plate, screen, grid bias, and signal voltages.
- ✓ Flexibility in switching simplifies testing present and future tubes.
- ✓ Durable heavy-gauge, light-weight aluminum case.

Model 798 combines broad utility, ruggedness, and dependable accuracy for maintenance of sound and electronic equipment. Detailed bulletin available. Weston Electrical Instrument Corporation, 617 Frelinghuysen Avenue, Newark 5, New Jersey.

## Weston Instruments

ALBANY • ATLANTA • BOSTON • BUFFALO • CHARLOTTE • CHICAGO • CINCINNATI • CLEVELAND • DALLAS • DENVER • DETROIT • JACKSONVILLE • KNOXVILLE • LOS ANGELES • MERIDEN • MINNEAPOLIS • NEWARK  
NEW ORLEANS • NEW YORK • PHILADELPHIA • PHOENIX • PITTSBURGH • ROCHESTER • SAN FRANCISCO • SEATTLE • ST. LOUIS • SYRACUSE • IN CANADA, NORTHERN ELECTRIC CO., LTD., POWERLITE DEVICES, LTD.



# TELEVISION FOR TODAY

## Part VIII—Video Amplifier Fidelity Considerations

THE VIDEO amplifiers of the television circuit are analogous to the a.f. amplifiers of the sound receiver. The rectified signal at the output of the second detector is too weak to adequately drive the cathode-ray tube and produce maximum contrast. Hence, the need for video amplifiers. The number is governed by the polarity of the rectified video voltage (as previously described) plus the strength of the detector output.

The requirements for video amplifiers must include uniform response from 10 cycles to 4.5 mc (approximately) and a phase shift which is either

the shunting capacities at the higher video frequencies. To this is added either a series or shunt peaking coil (sometimes both) to further maintain the response level to the highest video frequency desired. An illustration of each is shown in Figs. 1-b and 1-c. The values of  $R_L$  and  $L$ , with shunt peaking, are given by

$$R_L = \frac{1}{2\pi f C_t} \text{ ohms} \quad (1)$$

and  $L = \frac{1}{2} C_t R_L^2$  henries (2) where  $C_t =$  total shunting capacitance  $f =$  highest video frequency to be amplified by stage.

Series peaking, because it divides  $C_t$  into two components, permits us to ob-

ally of the addition of the filter,  $R_F$ ,  $C_F$ , as shown in Figs. 1-b and 1-c. At the middle and upper range of frequencies,  $C_F$  effectively bypasses  $R_F$  and the resistor is without effect. At low frequencies,  $C_F$  combines with  $R_F$  to increase the load offered to the signal and thus maintain a constant gain. Further,  $C_F$ , in conjunction with  $R_L$ , compensates to a great extent for the phase shift introduced by  $C_t$  and  $R_F$ . To accomplish this, we set  $C_F R_L = C_t R_F$ . Here, then, is the controlling design equation for the low-frequency compensation. The calculations commence with equations (1), (2) or (3), (4) and finish with  $C_F R_L = C_t R_F$ . Typical values of  $R_F$  and  $C_F$  are 5,000 ohms and 8  $\mu$ f, respectively. Other methods of

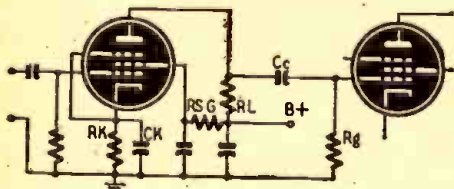

Fig. 1-a—The resistance-coupled amplifier.

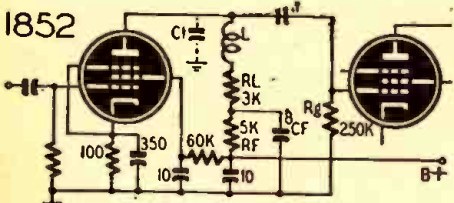

Fig. 1-b—The same, with shunt peaking added.

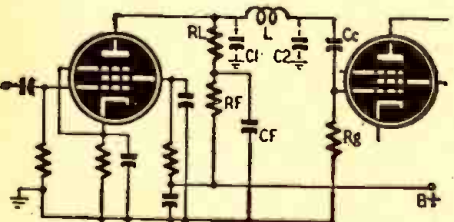

Fig. 1-c—Same, with a series-peaking circuit.

zero or else proportional to frequency. The importance of phase shift will be discussed presently; the frequency response requirement, however, should be self-evident from what has already been given. The video signal contains these frequencies and for the reproduction of full detail they must reach the cathode-ray tube.

The form of the video amplifiers has already been fully discussed in many places (see references at end of article) and no extended discussion is needed here. Briefly, an ordinary R-C amplifier (Fig. 1-a) is taken as the basis. The plate load resistor is decreased to relatively low values (1500-10,000 ohms) to minimize the effect of

tain a higher gain. The governing equations in this instance are:

$$L = \frac{0.5}{(2\pi f)^2 C_t} \quad (3)$$

$$R_L = \frac{1.5}{2\pi f C_t} \quad (4)$$

where  $C_t = C_1 + C_2$  (shown in Fig. 1-c),

Not only is the extension at the higher frequencies important, but the response characteristic must be rolled down to the vicinity of 10 cycles in order to prevent distortion of the slow changing background shading. Low-frequency compensation consists gener-

ally of the addition of the filter,  $R_F$ ,  $C_F$ , as shown in Figs. 1-b and 1-c. At the middle and upper range of frequencies,  $C_F$  effectively bypasses  $R_F$  and the resistor is without effect. At low frequencies,  $C_F$  combines with  $R_F$  to increase the load offered to the signal and thus maintain a constant gain. Further,  $C_F$ , in conjunction with  $R_L$ , compensates to a great extent for the phase shift introduced by  $C_t$  and  $R_F$ . To accomplish this, we set  $C_F R_L = C_t R_F$ . Here, then, is the controlling design equation for the low-frequency compensation. The calculations commence with equations (1), (2) or (3), (4) and finish with  $C_F R_L = C_t R_F$ . Typical values of  $R_F$  and  $C_F$  are 5,000 ohms and 8  $\mu$ f, respectively. Other methods of

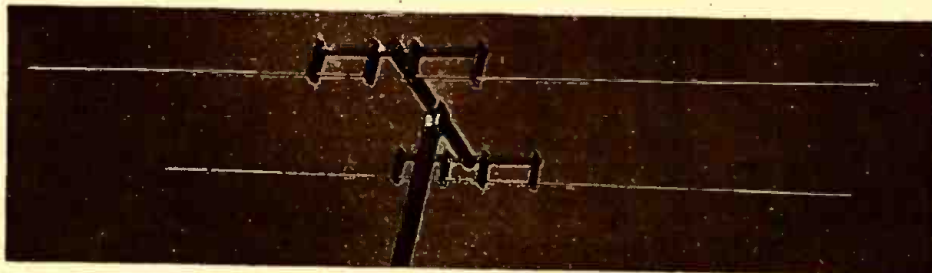

Courtesy Shur-Antenna-Mount, Inc.

Dipole television antenna with reflector which steps up gain and discriminates against echoes.

### PHASE DISTORTION

The effect of phase distortion upon a video signal (and consequently the image) is not as readily apparent as frequency distortion. Sound receivers are seldom troubled with phase distortion because our ears are largely insensitive to it. The visual effect is marked.

Phase distortion occurs whenever the phase relationships between the various (Continued on following page)

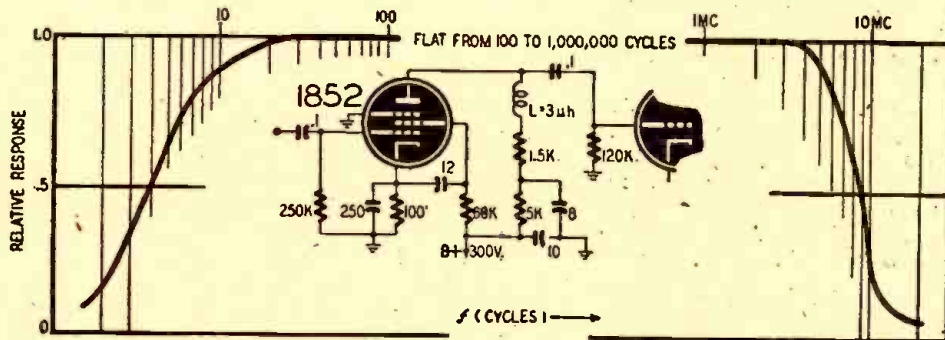

Fig. 2—Video amplifier circuit and response curve. Response is flat over broken portion.



portions of a complex wave are altered as the wave passes through a network. Of particular interest is the phase-versus-frequency characteristic of the resistance-coupled amplifier. The graph of a typical amplifier is shown in Fig. 3. It indicates quite clearly that the phase shift of such a circuit—as far as television application is concerned—is centered chiefly at the low and high frequency ends of the characteristic. Throughout the middle range of frequencies the phase shift is zero, which means that the video signals pass through without being affected.

Phase shift at the lower frequencies is due to the coupling condenser,  $C_c$ , of Fig. 1. When an alternating voltage ap-

portions of a complex wave are altered as the wave passes through a network. Of particular interest is the phase-versus-frequency characteristic of the resistance-coupled amplifier. The graph of a typical amplifier is shown in Fig. 3. It indicates quite clearly that the phase shift of such a circuit—as far as television application is concerned—is centered chiefly at the low and high frequency ends of the characteristic. Throughout the middle range of frequencies the phase shift is zero, which means that the video signals pass through without being affected.

portions of a complex wave are altered as the wave passes through a network. Of particular interest is the phase-versus-frequency characteristic of the resistance-coupled amplifier. The graph of a typical amplifier is shown in Fig. 3. It indicates quite clearly that the phase shift of such a circuit—as far as television application is concerned—is centered chiefly at the low and high frequency ends of the characteristic. Throughout the middle range of frequencies the phase shift is zero, which means that the video signals pass through without being affected.

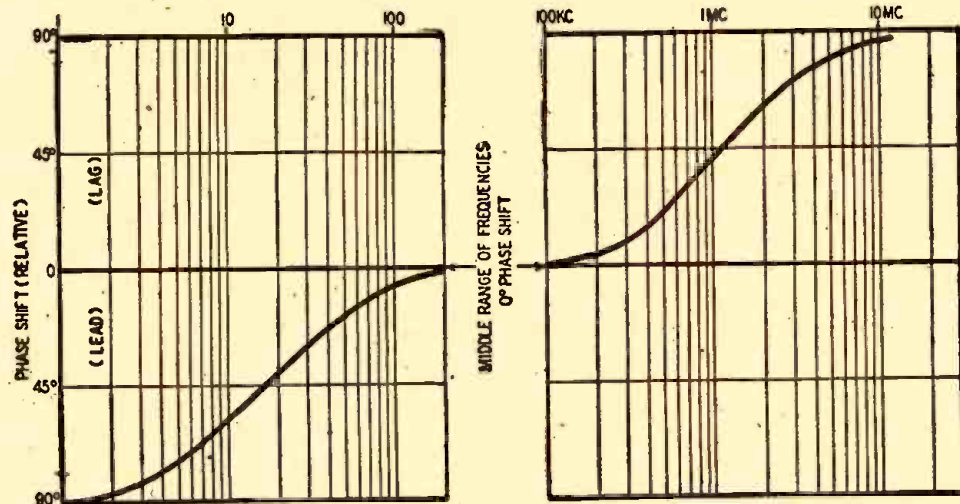

Fig. 3—Phase shift in video amplifier. Shift is negligible over the center of the spectrum.

pears across  $R_L$  (See Fig. 4), it is, at the same time, impressed across the series combination of  $C_c$  and  $R_g$ . The division of the voltage between  $C_c$  and  $R_g$  will be directly proportional to their respective impedances. As we lower the frequency of the applied voltage,  $X_c$  rises rapidly in value, reducing the effective voltage at  $R_g$ .

The phase angle between the voltage across  $R_L$  and the voltage across  $R_g$  will also be found to be a function of frequency. When the frequency is sufficiently high to make  $X_c$  insignificant with respect to  $R_g$  (say in the ratio of 1:10), then  $E_{RL}$  and  $E_{Rg}$  are essentially in phase. But with a decrease in frequency, we find an increase both in the ratio of  $X_c$  to  $R_g$  and the phase difference between  $E_{RL}$  and  $E_{Rg}$ . Graphically we have the situation shown in Fig. 5. This is the familiar impedance graph, with the resistance ( $R_g$ ) plotted along the abscissa and the reactance ( $X_c$ ) laid off along the ordinate axis. The angle, designated as  $\theta$ , represents the phase difference between the current in the series branch  $C_c$  and  $R_g$  and the applied voltage or  $E_{RL}$ . It also is the angle between  $E_{RL}$  and  $E_{Rg}$  since the current through  $R_g$  and the voltage across it are in phase.  $R_g$  remains constant, but  $X_c$  changes inversely with frequency. The plot in Fig. 5 illustrates that as we lower the frequency  $X_c$  increases and with it  $\theta$ . For the very low

these two voltages now would produce the complex wave of 6-d, little resembling the original wave. While an instance where the phase shift was made excessively large was chosen, yet over several amplifiers, such results may actually be obtained.

At the high-frequency end of the response characteristic (Fig. 3), we see that the phase shift again becomes appreciable. The reason now is due, not to

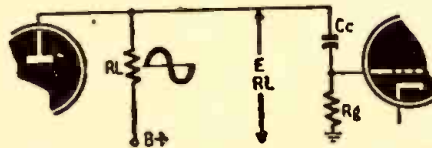

Fig. 4—Cause of low-frequency phase shift.

$C_c$ , but to  $C^T$ , the capacitances that act in shunt with the grid resistor.  $C^T$  comprises the output capacitance of the preceding tube, the input capacitance of the following tube, and the stray wiring capacitance that is ever present. From the equivalent schematic, Fig. 7, we see that as the frequency increases,  $C^T$  becomes increasingly important as a shunting path for the signal reaching  $R_g$ . More of the current is diverted from  $R_g$  and soon it becomes wholly capacitive with a resultant phase of 90 degrees.

#### VISUAL RESULTS

To explain the visual results of phase distortion, let us examine the correla-

tion between phase shift and time delay. Suppose that a video voltage is applied to a group of video amplifiers and further, that frequencies of 40 and 90 cycles are present in this wave. Since the lower frequency voltage will receive the greater phase shift, the 40-cycle wave may be shifted 45 degrees to possibly 10 degrees for the 90-cycle voltage. At the output of the network, the two frequencies will no longer possess the same relationship to each other as they had at the input. A simple calculation will indicate what the difference is.

A 40-cycle wave requires 1/40 of a second to complete a full cycle of 360 degrees. Proportionally, then, it will require 1/320 of a second for only 45 degrees. 1/320 of a second is approximately 0.003 sec. Hence, there will be this time difference between a maximum occurring at the input to the next tube and that occurring at the output of the preceding tube. The appearance of one will lag behind the other by 0.003 seconds.

The 90-cycle wave has a 10 degree phase shift. One cycle of a 90-cycle wave requires 1/90 of a second. 10 degrees would require only 1/3240 of a second, or approximately 0.0003 seconds.

At the cathode-ray tube, the electron beam moves across a 12-inch screen a distance of one inch from left to right in approximately 0.000,007 second. This time interval is extremely short and if waves are shifted as computed above, the visual result is a displacement of elements. The smearing is always from left to right, this being in the direction of motion of the electron beam. Smaller

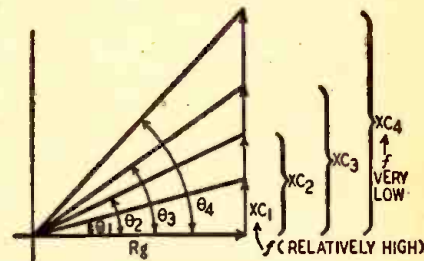

Fig. 5—Phase-angle shift at high frequency.

objects and fine detail become fuzzy or even tend to blend into each other, presenting an indistinct outline. Phase distortion will cause an incoming image with a perfectly white background to reproduce as a greyish hue, or even black. The reason for this can be experimentally determined by the reader himself. Take any complex wave (such as we would find representing a white video element) and break it down into its components. If any of these components are then shifted in phase, the resulting complex wave will have amplitudes at each point which vary from those previously possessed. But, in a television receiver, a change in amplitude results in a change of intensity or hue at the screen. Thus, it becomes evident that any change from a perfectly white spot could only result in something which has less white, or more grey or even black, depending upon the change in phase of the different components of the complex wave.

(Continued on page 131)



By J. SIMRIN

# MULTITESTER PLUS V.T.V.M.



The instrument shown here is as effective as many larger and more expensive units.

THE WRITER has for many years used a volt-ohm-milliammeter of home construction which originally had an analyzer unit built in it, but which he found of very little use in servicing modern radios. Having also a separate Electronic Voltmeter built from an article taken from RADIO-CRAFT some three years ago (see "A Simplified Electronic Voltmeter" by Harold Davis, RADIO-CRAFT, Jan.-Feb., 1943) it was decided to rebuild the original instrument, and by doing without the analyzer section, incorporate the electronic voltmeter in its place.

The completed instrument is an efficient, compact job, built on an aluminum panel only seven inches square. Either instrument can be used independent of the other by turning one switch. It is housed in a wooden case, measuring 10 x 10 x 3 inches, leaving a space at the top for the test leads and a compartment at the right for small tools. There are no special or home-constructed switches; each is a standard article which may be purchased at almost any parts supply house. Sw2, which is a 3-pole six-gang switch, selects the use of the tester. Left position is volts, center mils and right electronic voltmeter, or e.v.m. In this position the meter is switched into the e.v.m. circuit and the A and B batteries turned on at the same time. It should, of course, not be left in this position when the e.v.m. is not in use, as the batteries would be needlessly drained. The A battery is an ordinary flashlight cell and the B is a 45-volt midget type with snap-on terminals.

Jacks 1 and 2 are used for volts and mils, 1 and 3 resistance high range, 1 and 4 resistance low range, with Sw1 set for low ohms. Sw1 is a d.p.d.t. and has the left position off so that the midget neon lamp may be used without the meter by plugging the test leads into jacks 2 and 6. The neon lamp will light when the line plug is being used and Sw8 thrown in, serving also as a warning that high voltage is being used. Sw8 permits the line plug to remain inserted in a wall receptacle at all times and can be turned on only when desired.

Values of the milliammeter shunts are not given as they will depend on the ranges desired and the internal resistance of the meter being used. A separate set of resistors was used for the

a.c. ranges and are approximately 10 percent lower in value than the corresponding d.c. resistors. To save space all shunts and series resistors were mounted on Sw3, which is a 2-gang 11-point switch.

Condensers up to 0.1  $\mu$ f can be tested for capacity through jacks 1 and 6. Sw5 is turned to a.c., Sw3 set to a range that will show full scale or nearly so, with the test leads shorted when line Sw8 is on. Sw2 must be set for volts of course, as the line voltage is being read for this test. The tap on Sw3 marked Line Control is merely a fixed resistor in series with a small volume control and switch (Sw9) which is used to short jacks 1 and 6 and then allows the line voltage to be adjusted to full scale reading on the meter. Electrolytics and paper condensers over 0.1  $\mu$ f can then be checked for capacity through jacks 1 and 4. The a.c. voltmeter can be used as an output indicator through jacks 1 and 5; a .02 condenser is in series with J5 to block any d.c. present.

A novel and simple method of determining very low resistances for locating shorted turns in coils, etc., is used. Sw6, a push-button type, is wired across the 4,000 ohm resistor in the ohmmeter circuit and is normally open. With the meter set for low ohms and

test leads in jacks 1 and 4 connected to a low-ohmage resistor or coil winding, depressing Sw6 will short out the 4,000-ohm resistor and allow a greater current to flow. The resistance under test is a shunt across the meter, and values up to about 6 ohms may be safely tested this way. Even a small fraction of an ohm will show an appreciable reading. The pushbutton should be released

(Continued on page 138)

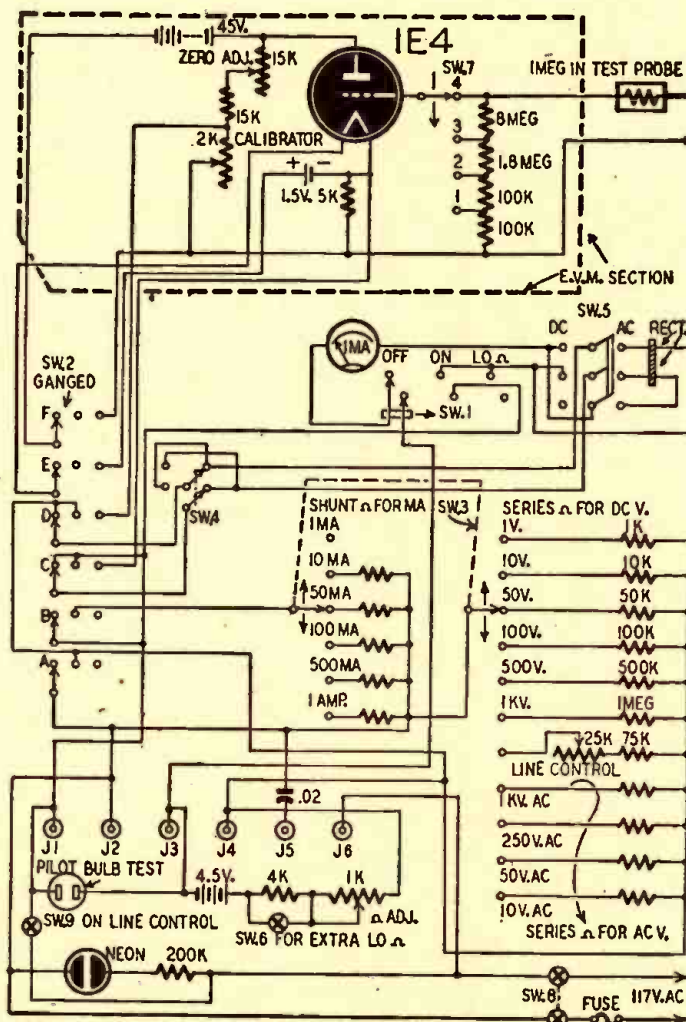

Considering the number of circuits, construction is fairly simple.



# 343 RADIO DATA SHEET

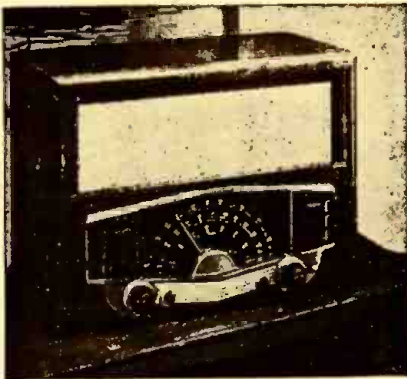

## ZENITH RADIO

Models 8H032, 8H033, 8H050, 8H052, 8H061

FM-AM A.C. SUPERHETERODYNES

Tube Complement: 6AG5 r.f. amp; 6SB7 converter; 6SG7 1st i.f. amp; 6SH7 2nd i.f. amp; 6SH7 limiter; 6S8-GT discriminator-detector and 1st a.f.; 6K6-GT power output; 5Y3-GT/G rectifier.

Power Rating: 0.645 amp at 117 volts

Tuning Range: AM 540-1620 kc; FM 42-48.5 mc; 88-108 mc.

### ALIGNMENT PROCEDURE

The 8C20 chassis incorporates a superheterodyne circuit with two stages of i.f., and one stage of r.f. amplification on all bands.

#### AM ALIGNMENT

The alignment of this chassis on the

standard broadcast band is conventional. The alignment slugs in the i.f. transformers are threaded and screw into the coil forms. The slugs are slotted for a small size fiber screw driver. *Do not press hard* on the aligning tool (fiber screw driver) or the *threads* in the coil

forms will strip and adjustment will be impossible.

#### FM R.F. ALIGNMENT

The same coil slug arrangement which tunes the 100 mc FM band also tunes the 45 mc band. However, on 45

Operation	Connect Oscillator to	Dummy Antenna	Input Signal Frequency	Band	Set Dial To	Adj. Trimmers	Purpose
1	Pin 8 on converter tube 6SB7 socket	.05 mfd	455 kc Modulated	BC	600 kc	L-14, 15, 18, 19, 22 and 23	Align i.f. channel for maximum output
2	Pin 1 on r.f. tube 6AG5 socket	.05 mfd	455 kc Modulated	BC	600 kc	C7	Adjust wavetrap for minimum output
3	2 turns loosely cpd. to wavemagnet		1600 kc Modulated	BC	1600 kc	C9	Set oscillator to dial scale
4	2 turns loosely cpd. to wavemagnet		1400 kc Modulated	BC	1400 kc	C2 & C6	Align det. and ant. stages
5(a)	Pin 4 (grid) on 6SH7 limiter socket	.05 mfd	8.3 mc Unmodulated	FM 45		L24 coil slug Primary discr.	Align primary of discriminator for maximum reading
6(b)	Pin 4 (grid) on 6SH7 limiter socket	.05 mfd	8.3 mc Unmodulated	FM 45		L25 coil slug sec. of disc.	Adjust secondary of discriminator for zero reading
7(c)	Pin 4 (grid) on 6SH7 2nd i.f. tube socket	.05 mfd	8.3 mc Unmodulated	FM 45		L20 & L21 Prim. & sec. of 3rd i.f. trans.	Align 3rd i.f. transformer for maximum reading
8(c)(d)	Pin 4 (grid) on 6SG7 1st i.f. tube socket	.05 mfd	8.3 mc Unmodulated	FM 45		L16 & L17 Primary & sec. of 2nd i.f. transformer	Align 2nd i.f. transformer for maximum reading
9(c)(d)	Pin 8 (grid) on 6SB7 converter tube socket	.05 mfd	8.3 mc Unmodulated	FM 45		L12 & L13 Primary & sec. of 1st i.f. transformer	Align 1st i.f. transformer for maximum reading
10(c)	Antenna Post (Remove line ant.)	270 ohms	98 mc Unmodulated	FM 100	98 mc	L7 osc. coil slug	Set oscillator to dial scale
11(c)	Antenna post (Remove line ant.)	270 ohms	98 mc Unmodulated	FM 100	98 mc	L2 & L3 det. and r.f. coil slugs	Align det. and ant. stages to maximum reading
12(c)	Antenna post (Remove line ant.)	270 ohms	45 mc Unmodulated	FM 45	45 mc	C29	Set oscillator to dial scale
13(c)	Antenna post (Remove line ant.)	270 ohms	45 mc Unmodulated	FM 45	45 mc	C5 and C30	Align detector & ant. stages for maximum reading

**IMPORTANT:** Alignment of this chassis will in most cases be unnecessary unless an i.f. or r.f. transformer is replaced or the adjustments have been tampered with.

Correct alignment can only be made if the following procedure is followed:

A vacuum-tube voltmeter with an isolation resistor of 200,000 ohms in series with the hot lead will serve for FM adjustments. This lead should be shielded.

An a.c. output meter connected across the primary or secondary of the output transformer will be satisfactory for all AM adjustments.

The signal generator output should be kept just high enough to get an indication on the meter.

(a) Vacuum tube voltmeter pin 5 on discriminator transformer to chassis (half discriminator load).

(b) Vacuum tube voltmeter pin 7 on discriminator transformer to chassis (full discriminator load).

(c) Vacuum tube voltmeter 6SH7 limiter grid (pin 4) to chassis.

(d) 300-ohm 1/2-watt carbon resistor soldered across the secondary L17 (pin 2 and 3 of 2nd, i.f. trans.). The leads to the resistor must be as short as possible and the resistor removed before operation 10 is started.



# RADIO DATA SHEET 343

mc the band switch connects trimmer condensers in parallel and padding wires in series with the 100 mc coils. The tuning slugs are attached to threaded shafts and the slugs are varied in the field of the coils by turning the shafts clockwise or counter-clockwise. After adjustments the shafts must be secured with a drop of speaker cement. This will prevent changes due to vibration or tampering.

## FM I.F. ALIGNMENT

The same type of tuning slugs for aligning the AM i.f. amplifier are used for the FM i.f.'s. Observe the same precautions when making adjustments. The second 8.3 mc i.f. stage is overcoupled. Overcoupling gives a wide band pass with good sensitivity. When an

overcoupled stage is aligned with an unmodulated signal, the stage must be loaded. A 300-ohm carbon resistor soldered across the secondary of the second i.f. transformer provides a satisfactory load for this circuit. The resistor leads must be kept short to reduce the distributed capacity of the circuit.

When aligning a loaded stage, it will be found that considerable signal from the generator will be required, and that it will tune broadly. **THE LOAD RESISTOR MUST BE REMOVED AFTER ALIGNMENT.**

If the signal generator used does not have sufficient output to overcome the temporary loss caused by the load resistor, the load resistance may be increased or the signal fed into the preceding stage.

## FM DISCRIMINATOR ALIGNMENT

When the secondary of the discriminator is aligned (operation 6) use sufficient signal input to get a good positive and negative indication before setting the slug for zero reading. A center zero indicating meter is recommended for this adjustment, but is not absolutely necessary. Reversing the leads of a non-zero center meter, or observing closely when this meter starts to go to the left (negative) of zero will give the same results.

Alignment of FM receivers is a special job and calls for knowledge of their characteristics. Articles on FM servicing were printed in RADIO-CRAFT, March 1946 and March 1944.

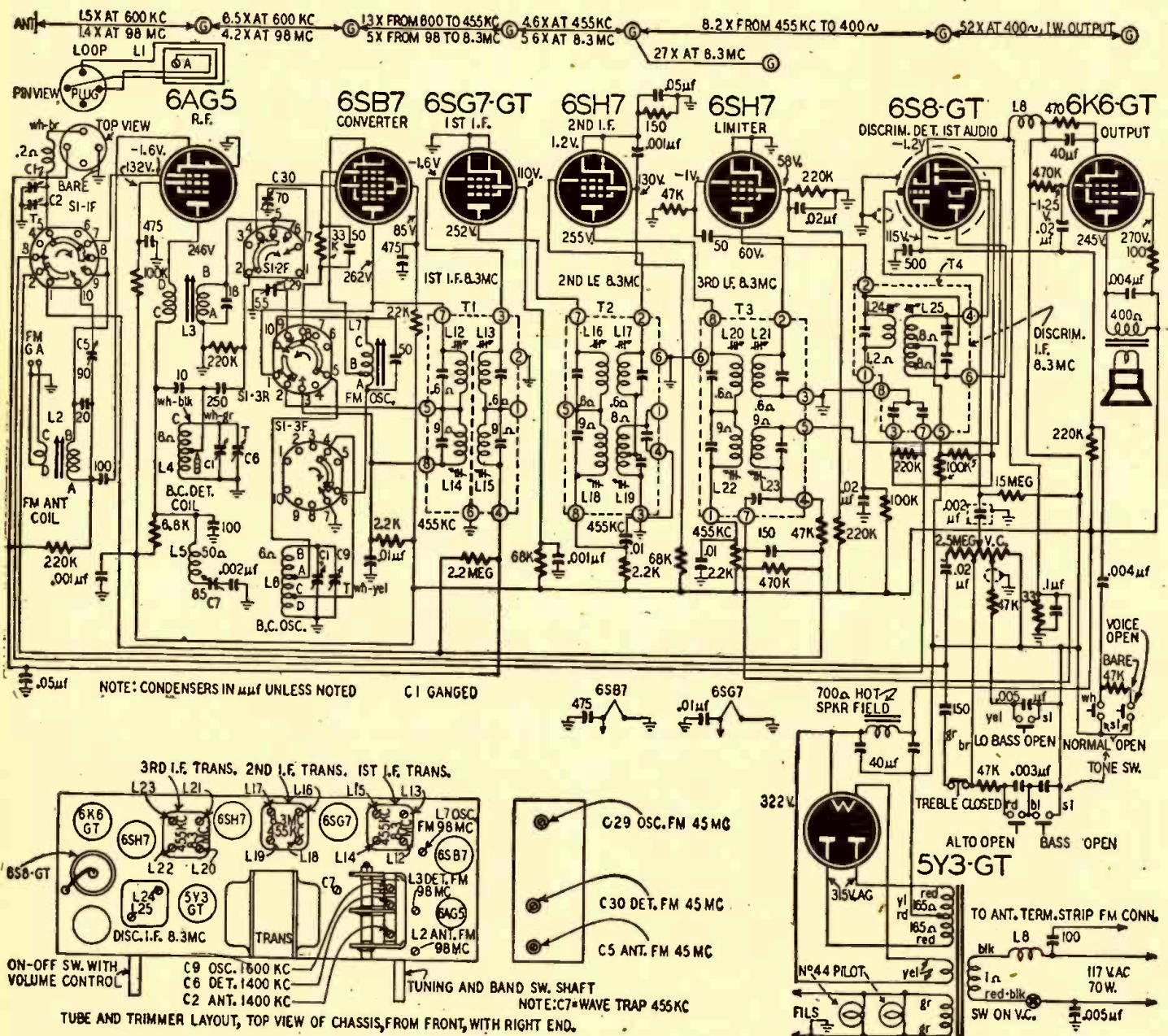



# TRAINEE FIVE RADIO

## This Simple, Experience-Tested Set Is Easy to Build

**D**URING the war it was common practice for a student to construct a practical and useful radio to familiarize himself with wiring practice, mounting of parts, soldering, alignment, and to generally broaden his knowledge and put his "book learning" to use. These radios were usually t.r.f.'s or superhets employing not more than five tubes. This is such a set and is not unlike the common a.c.-d.c. radio.

The superhet circuit used has a 6K8 converter, a 6SK7 i.f. amplifier, a 6SQ7 detector and first audio a 25A6 audio output and finally a 35Z6 rectifier. (A 25Z6 can be used.) It is conventional in every respect with no tricky circuits.

Drilling and punching the chassis is the first step. Tools needed are: a good "egg-beater" type drill, an assortment of small twist drills, a circle-cutter or

chassis punch for tube sockets, and miscellaneous items as a pocket knife, center punch, hammer, and others.

Probably the most difficult job is the cutting of the opening in the chassis for mounting the speaker, but this may be done easily enough if an electric grinder is handy, as the opening may simply be ground away. If this is not possible a hacksaw or coarse file may be used.

After drilling is finished the tube sockets, tuning condenser, i.f. transformers, output transformer, choke, and volume control are mounted. Details of the dial drive are given in Fig. 2.

Due to the possibility of puncturing the speaker cone, the speaker should be mounted last or a piece of cardboard taped to the speaker for protection. Filament wiring should be first, this identifies connections on the tube bases easily as

the filaments on all five tubes are numbers 2 and 7. It is also advisable to ground the No. 1 pin on each socket.

As a result we have convenient ground connections. Cathodes and grids are next in order of wiring and should be soldered in with care. All suppressors should be tied to the cathodes. After the cathode and grid connections have been double checked, screen grids and plates are connected last. Don't rush, wire slowly!

Having completed all wiring and thoroughly checked each connection, the set is ready for its first try-out. After it has warmed up, a very low hum should be heard in the speaker with volume control set at maximum. If the i.f. transformers are new they have been peaked at 456 kc and some sort of signal should be heard.

If no signal generator is available, a fairly good job can be done by ear. Tune in a weak station and align the oscillator and antenna-coil trimmers for maximum

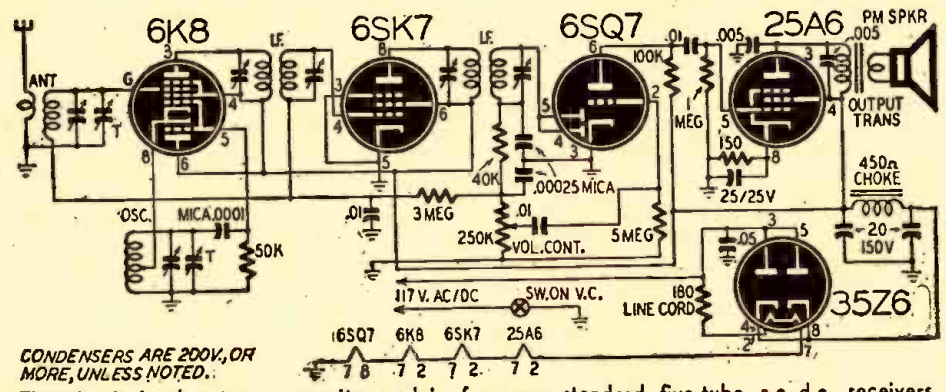
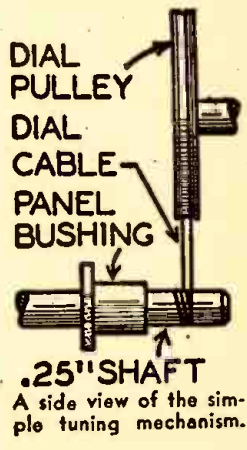

CONDENSERS ARE 200V, OR MORE, UNLESS NOTED.

The circuit is almost a composite model of prewar standard five-tube a.c.-d.c. receivers.

(Continued on page 120)

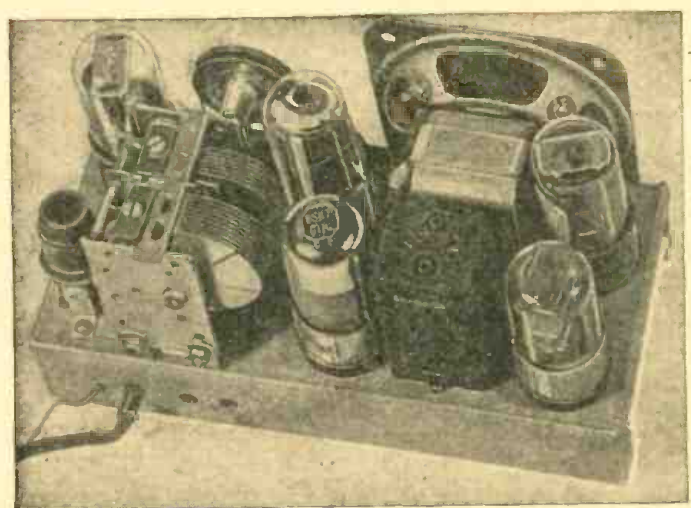

The chassis layout, also follows standard practise. Alignment problems are considerably simplified by using the cut-plate condenser.

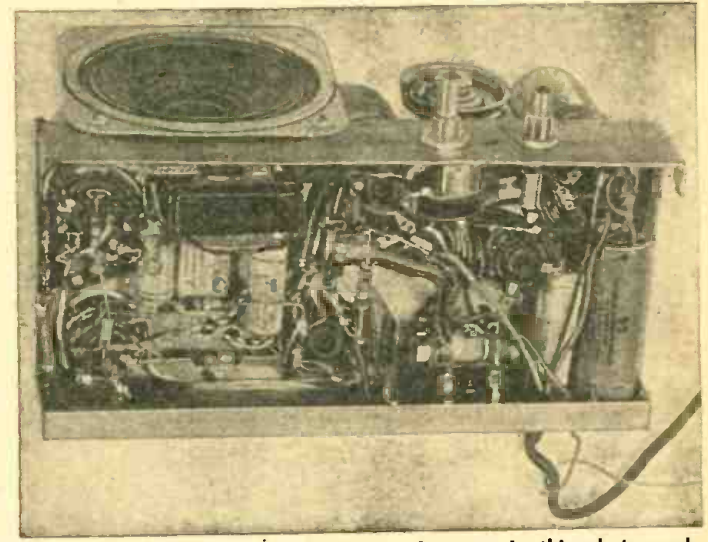

Layout of parts under the chassis can be seen in this photograph.



# CABINET REFINISHING

## Appearance-Enhancing Repairs Are Simple and Rapid

**T**HE RADIO serviceman usually gets paid little enough for his time, and may feel that he can ill afford to "throw in" any cabinet fixing or refinishing. This is shortsighted. Work on the cabinet is often the only work the customer can see. A little touching up of the cabinet will have an effect out of all proportion to the work required. Often the customer will be willing to pay for improving the appearance of a shabby cabinet. Here are some suggestions for quick results:

1. White spots. Try using furniture polish. On shellac, try wood and denatured alcohol. On varnish, use turpentine.
2. Scratches of various kinds.



Photographs Courtesy General Cement Co.

A simple kit of the type above will cover most cabinet repair jobs.

a. For very light scratches, try furniture polish, or rub with a hard wax like "Butcher's Wax" which fills in the cut somewhat; or use shoe polish, of the wax type.

b. For deeper scratches, apply a varnish stain of approximately the right color with a fine brush in the scratch. Rub off surplus with a safety razor blade held at right angles to the surface. Allow to dry, then sand with 00 sandpaper on a small piece of board (to keep the paper flat); repeat the process, when necessary.

c. For the very deep cuts or scratches, fill the opening with a crack filler, mixed with varnish stain, or with crack filler using varnish stain over it. Rub off the surface with razor blade, then allow to dry and smooth with 00 sandpaper.

A crack filler may be made of speaker cement plus powder made by sanding wood with fine sandpaper. Plastic wood will do for very large cracks or holes,

but is coarse in texture, does not stick to shallow holes or tiny cracks, and does not take an oil stain. A cement that dries too quickly may not work well in making a "homemade" crackfiller.

### STICK SHELLAC

Stick shellac is a resin-like substance put up in sticks like sealing wax. It is excellent in skilled hands for filling in all kinds of dents and cracks. It is not good for putting on the corner of a cabinet, because it won't stand abuse, but is a favorite of furniture stores for quick repairs. It comes in various colors and is inexpensive, and may be bought at the larger hardware and paint supply stores.

A spatula (like a thin putty knife) is heated in the flame of an alcohol lamp and the stick shellac is then melted off with the knife and on to the wood. It takes experience to keep the knife at the right temperature to melt the material and make it lie flat and smooth it off. A little quick drying varnish or shellac over the stick shellac repair will hold it in place and prevent its being damaged by wear.

### FRENCH POLISHING

French Polish is a very thin white shellac plus a little linseed oil or lemon oil. The oil prevents sticking when the solution is rubbed with the rubbing pad.

This pad is made of cotton inside a lint-free outer cloth. Dip the pad in the solution and then lightly rub the part to be touched up with a circular motion, in about a three- or four-inch circle. When dry, sand lightly. Repeat the operation several times if necessary. After the first coat, take care not to rub too hard or

too long, so that the under coat is not softened too much and rubbed into.

This method is particularly useful in fixing checked "crackled" finish; the finish is sanded with fine sandpaper, then French polished; sanded again and French polished.

Remember that French polishing and even crack filling is *skilled work*. Experiment with your own cabinets and be sure you can do a good job before attempting to work on a customer's radio.

### COMPLETE REFINISHING

Sometimes the defects are so numerous, that too much time would be required to repair many small blemishes. Then the whole finish may be removed with varnish remover, used according to directions with the remover. In general the remover is applied with a brush, allowed to remain say fifteen minutes, and then the softened varnish is scraped off with a broad-bladed putty-knife. It may be necessary to repeat the application. Finally the remnants may be washed off with turpentine, aided by steel wool (fine), and Dutch Cleanser, followed by a moist rag. An oil stain of proper hue is then applied, followed by shellac, varnish, lacquer or whatever is to be used for a finish. This is allowed to dry very thoroughly and then sanded smooth. Very fine steel wool can also be used. A second coat is generally needed for a good gloss. If a satiny finish is desired, the last coat can be rubbed with rottenstone and linseed oil rubbed with a piece of woolen overcoat, and hard wax lastly applied and rubbed. In doing any varnishing, it is absolutely essential that the brush and the varnish be absolutely clean, and that the drying take place.

(Continued on page 100)



The skilled worker will make good use of more elaborate equipment.



# A SIMPLE METRONOME

A LITTLE more than a year ago RADIO-CRAFT started the idea of an electronic metronome. Since then, two firms put on the market an electronic metronome. The metronome is much more of a gadget than an instrument. The radio engineer could humorously consider it as the oldest (?) mechanical generator of synchronizing pulses.

Provided the rate of repetition of the "click" is kept with a constancy, let us say, within 1/25th of a second, the contraction is perfectly acceptable. To achieve such a modest result as far as accuracy is concerned, it seems that we should not bother with vacuum-tube or thyratron circuits; in fact, the end would barely justify the means. A simple and elegant solution of the electric metronome can be obtained by the modification of the basic circuit of Fig. 1.

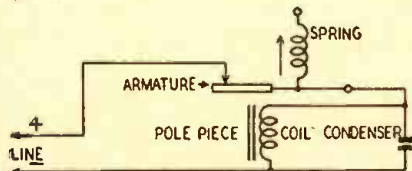

Fig. 1—The fundamental time-delay circuit.

The large condenser positioned across the relay coil charges up to the d.c. voltage applied to the power wires. By the time the condenser is charged, a current of increasing intensity starts to flow through the relay coil, attracting the armature and therefore disconnecting the entire system from the power supply. The condenser now discharges through the coil and when the charge is partially reduced, the armature is pulled up by the spring so that the entire cycle may repeat over again in rhythmic succession.

The "tempo" range of the metronome is between 40 and 208 clicks per minute. To obtain this variation we can introduce into the circuit a variable resistance which will discharge the condenser according to different time constants (Fig. 2).

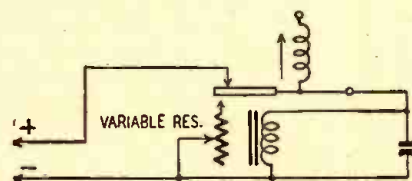

Fig. 2—Variable resistor controls the tempo.

When the coil becomes sufficiently energized, the upper contact disconnects and the lower contact is made. The variable resistor is now in parallel

with the condenser and the coil, and by varying its value we have a means of discharging the condenser more or less rapidly. This modifies the rate of repetition of the clicks of the relay: the faster the condenser is discharged, the more clicks are beaten out per minute.

A further simplification of the metronome is offered by itself at this point. The slamming of the armature against the pole piece produces a loud enough noise which sounds very much similar to the one which is produced by the escapement of the classic winding metronome. This noise can be emphasized by mounting the relay on a thin panel of dry wood. A loudspeaker is not necessary. A second noise that must be eliminated is sometimes heard when the armature is pulled up by the spring against the upper contact. This damping can be achieved by reducing the spring tension and by cementing some rubber layers between the contact holders in such a way that the contact actually takes place at a low speed.

Of course, instead of the noise of the relay, a chime or bell may be regularly hit each time the armature swings in one direction. With an additional pair of contacts, a light may be flashed at the same time.

The complete circuit is presented in Fig. 3. The relay we used is manufactured by the Allied Control Company (Number 806 D 42) for 110 volts d.c. and has a resistance of 2500 ohms. The

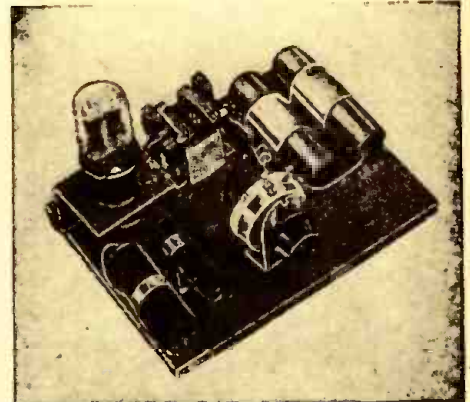

The metronome is a form of time-delay relay.

compression type spring has been weakened by clipping the top turn. The condenser values may be found different from the ones suggested, because of

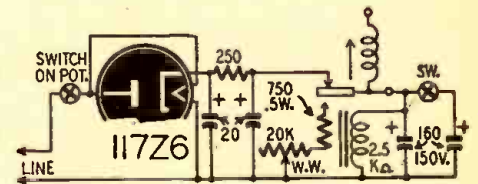

Fig. 3—Complete circuit of simple metronome.

the various leakages of different condensers. The value of 320  $\mu\text{f}$  should enable calibration between 40 and 100 clicks per second. By keeping in the circuit only 160  $\mu\text{f}$ , calibration will be possible between 90 and 208 clicks. The 160  $\mu\text{f}$  condensers are made up by paralleling two cartridges, each 40 + 40  $\mu\text{f}$ , working voltage, 150.

The contacts must be kept clean, because if they are not, their resistance cannot be equal for each time, and therefore the constancy of the rate of repetition may deteriorate.

## TEST HOLDER FOR CRYSTAL GRINDING

ANY transmitting radio amateur who grinds his own crystals will appreciate this test holder as a time saver. With it a crystal in process can be quickly tested for frequency.

Saw off the cylinder portion of a tube base (old style, large size) until just the bottom is left. Face this down on a stone until perfectly flat. Remove the solder from the two prongs to be used. Drill a small hole into the edge of the bakelite opposite one prong and thread for a small bolt. Then solder a very fine wire from this bolt into the prong.

Cement a disk of thin cardboard to the top of the tube base and punch a tiny hole just over the remaining prong.

Next saw out two circular plates from heavy, extremely flat-surfaced brass. Solder a fine wire to the bottom face of one plate, run it through the hole in the cardboard and solder into the remaining prong. Additional cement should be used to hold this plate onto

the cardboard. The crystal is placed on this bottom plate and the second plate laid on it. Then a flexible but reasonably strong spring is clamped under the little side bolt and bent to press firmly but lightly onto this top plate.

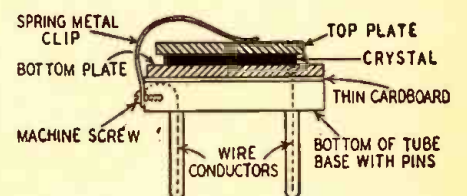

Be sure and flatten the surface of each plate that contacts the crystal on a fine and perfectly flat new emery or oil stone. With this holder it is necessary only to remove the top plate, slip in the crystal and reset the plate. After a few adjustments of plate pressure this makes a rapid and sure crystal tester.—L.B.R.



# SOUND ENGINEERING - No. 26

This department is conducted for the benefit of all RADIO-CRAFT readers. All design, engineering, or theoretical questions of general interest on PA installation, sound equipment, and audio amplifier design will be answered in this section. No circuit diagrams can be supplied by mail, all answers being printed in order of their receipt.

(Note: when questions refer to circuit diagrams published in past issues of technical literature, the original, or a copy of the circuit should be supplied in order to facilitate reply.)

## QUALITY IMPROVEMENT

### The Question . . . .

My brother and I, liking classical music, and having only a Majestic combination radio phonograph, Model 181, decided to build an amplifier and use it until good amplifiers were again on the market.

We saw an amplifier described and pictured in a radio magazine (not RADIO-CRAFT). We built it, but couldn't get full expansion at all settings of the input control. The overall tone was not good, and the high notes didn't sound real, whether bass or treble boost was turned on or off.

A serviceman friend tested the set and got 5.7 volts on the filament, and 300 volts on the plates of the tubes. He said that the power transformer should have a filament winding (6.3 volts) of at least 2.9 amps. We had a used power transformer but wanted to get your advice before obtaining a new one. Would you suggest using the power transformer shown in the diagram or a different rated one. Everything else is as the diagram shows except the driver — A Stancor 1 to 1; 3 to 1 and 6 to 1, the latter of which we are using. We have a Shure Crystal Pickup and a Jensen PM 12-inch 12-watt speaker.

We are sending the schematic diagram along (Fig. 1) and would appreciate suggestions of what you would do if you were building the set.

If, after getting your advice, and we can't get the set working, is there any place we can send it to be checked and serviced?

Thank you for any advice or time you may be able to give us, I am

ALFRED ROSS,  
Freeburg, Illinois

### The Answer . . . .

Full expansion can be obtained only with adequate input into the 6C5 expander amplifier. Expansion takes place when a voltage is developed across the cathode resistor of the 6H6, and this will not occur if the volume control in the expander circuit is turned down. The best way to adjust the input control for maximum expansion is to turn it all the way up and then gradually increase the input volume control (grid circuit of 6SK7) until the desired output level is attained.

Unrealistic reproduction of the higher frequencies may be caused by one or more of the following reasons:

- A. Overload distortion of the input stage.
- B. Overloaded driver stage.
- C. Poor frequency response in driver

or output transformer.

D. Excessive distortion in output stage caused by poor regulation of power supply.

As you can surmise, Mr. Ross, the circuit that you selected is not the best type for an amplifier of the kind you want. In the first place, a Class-B amplifier necessitates carefully coordinated design and if any one of the circuit elements are not correct, substantial distortion is introduced. While the total 6.3-volt heater current of the amplifier is 2.9 amps., any good transformer rated at 2½ amps. should be adequate. If, however, the voltage actually drops down to 5.7 volts, it is a sure sign that the transformer has very poor regulation. This will contribute substantially to the distortion in the output stage, as one of the prime requisites of a Class-B Amplifier is excellent regulation, both in the power supply and the driver stage. I believe, too, that you have inadequate driving power, and if I were to build this amplifier at all, I would use a 6N7 as a driver, connecting both plates and grids in parallel, with a 900-ohm ½-watt cathode resistor bypassed by at least a 25-μf 25-volt electrolytic condenser. To improve regulation, a mercury-vapor rectifier tube should be used. Condenser input should not be employed in the filter circuit.

You might save yourself a good deal of time, trouble and money, if you constructed a standard Class-A amplifier instead of the type you now have. I can't suggest any place that you might send the amplifier to have it checked, but possibly some RADIO-CRAFT subscriber in your locality, who is capable of helping you, might contact you.

## SCRATCH ELIMINATION

### The Question . . . .

Several months ago I purchased a record changer and found out that it could not be hooked up to my radio due to the age of the set. I was told that when my radio was built they used magnetic pickups. In searching for an amplifier, a friend of mine who is a "ham" operator told me that he knew of a unit that I could purchase at a reasonable price and convert it to an amplifier.

He then tore everything out leaving the 27 driving 2 45's in push-pull, then he added a 57 as an input stage, driving the 27 and 45's.

Now this amplifier works very well except for one thing; there is a good deal of needle scratch in the background. I do not know much about this sort of a hookup except what I have picked up in the last several months while working with this amplifier. Now I would

(Continued on page 132)

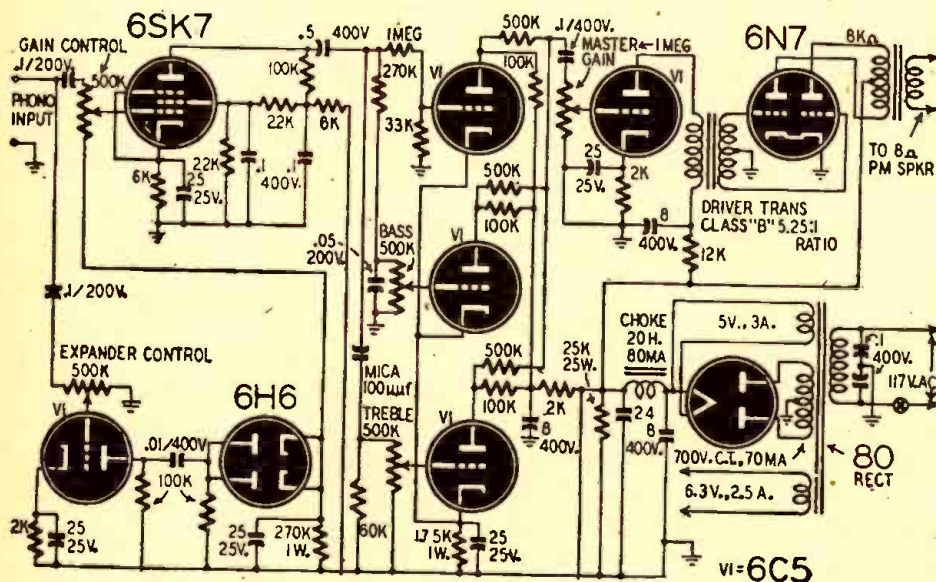

Fig. 1—Amplifier referred to above. Tubes marked VI are 6C5's.



# TRANSATLANTIC NEWS

From our European Correspondent, Major Ralph Hallows



**B**EFORE the war television transmissions were conducted in three European countries, France, Germany and Britain. The French service was largely experimental. It covered a very small part of the country and such receivers as were in use belonged mainly to those more interested in the technical than in the entertainment aspect of the art. In Germany the position was much the same, in that there was a restricted service and few privately-owned receiving sets. Like most other departments of applied science, German television was organized by the Nazis mainly on a propaganda basis. There was no attempt to make reception a popular hobby. Demonstrations at exhibitions and so on aimed at showing that German technicians were not lagging behind those of other countries. It is hardly surprising that prewar television in France and Germany made little appeal, if any, to the ordinary man and woman. In neither country was there any attempt to popularize it.

In Britain the position was very different. A regular service of high-definition television (405 lines, 50 frames per second interlaced) was started by the BBC in the summer of 1936, with programmes of three to four hours every day. There were many who predicted a colossal boom in television receivers. For some years before these transmissions started television had received more publicity in the press than anything in the history of newspapers. Crowds had flocked to any and every television demonstration. Television was one of the common topics of conversation. But there wasn't any boom then and there has not been one since. Nor does there seem to be any likelihood of a rush to buy television receivers, now that they are becoming available again.

The BBC's London television station serves nearly one-third of our population, but the outside estimate for the number of televisions in private ownership in 1939 was a mere 20,000. Nor had our public been badly oversold by advertising. Video receivers, giving a small picture, could be bought in 1938 for as little as \$125. A receiver producing a 10- by 8-inch image, also providing sound reception on the broadcast band and on the short waves, could be had for between \$250 and \$400. Tele-

visors are just coming on to the market again and prices will range from about \$175 for an instrument providing a 5- by 4-inch picture and sound on the broadcast band to \$400 for one with a 10- by 8-inch image and sound reception on all frequencies used for broadcasting. Some will cost more than this; but I doubt whether the price of the most elaborate, containing a 15-inch cathode-ray tube, covering 20 megacycles to 150 kilocycles on sound and incorporating a phonograph with automatic record changer, will run to much over \$1,200. Will there be any rush to buy such television receivers this winter? I wish I could believe there would; but I just can't.

Television has had every chance of making good in Britain: all the free publicity and ballyhoo that any salesman could pray for; a three-year's continuous service before the war and the service in full swing again for the past six months; programs unsponsored and free from all publicity matter; most important of all, a public definitely interested in television and eager to have it. Why, then, is television not going ahead here?

The reason is that the cathode-ray

own view is that manufacturers would be wise to soft-pedal cathode-ray tube television.

## V.H.F. DIVERSITY TRANSMISSION

You may remember that I gave some account a short time ago of a v.h.f. amplitude-modulated system of diversity transmission developed for the use of our police autos. The basis of the method is that messages are sent simultaneously by three transmitters using different carrier frequencies. The receiver has wide-band r.f. circuits which pull in all of them and the strongest at any instant automatically captures the detector stage. The result is that there is no flutter or fading, even when an auto is moving rapidly through a district where there are hills, high buildings and other screening objects. A diversity system on similar lines is now being developed for the use of aircraft flying on inland routes. It is likely to be employed in a variety of ways, such as indication of positions, issuing of storm, fog and other bad weather warnings, and the marshalling of aircraft wishing to land at aerodromes. Trials so far made show that diversity transmission is a more reliable method of maintaining v.h.f. speech between ground and aircraft than any other yet known.

## AIRCRAFT RADIO

Talking of aircraft radio recalls a conversation that I had the other day with the pilot of a big passenger machine. He was all in favor of radio and radar as aids to navigation and safe landings, but was beginning to think that it was being rather overdone in large planes. His own "kite", he told me, had no less than *seventeen* different antennas! The reason for such a fantastic array is that at present each country operates its own special navigational and landing systems. An airplane which makes transatlantic and other international trips has to carry the equipment needed to deal with several of them. Hence the forest of antennas and a needlessly heavy and bulky radio and radar outfit. An international commission now meeting in the United States will try to tidy things up a bit by standardization of equipment in all countries. May they be successful, for if every country continues to develop air navigational aids on its own lines there will soon be no room in long-distance aircraft for either cargo or passengers!

## TOWARDS SIMPLICITY

What has struck me very much lately about the radar gear of aircraft is the tendency to get right away from the wartime presentation of navigational data on the screens of cathode-ray  
(Continued on page 128)

## RADIO TERM ILLUSTRATED



Amplitude

Suggested by:  
M. Kosinski,  
Brooklyn, N. Y.

tube does not provide the television that the ordinary man and woman want. They don't like the small picture; they want a screen about as big as that used for home movies. As RADIO-CRAFT rightly suggested in its September editorial, the cathode-ray tube and scanning systems don't give the answer that the public wants. I can't think that the cost matters that much in these days of high wages and deferred payments. Offer the public real television, not just something showing what it might be, and they will go for it. But until the needed basic invention comes along my



**NOW AVAILABLE FOR IMMEDIATE SHIPMENT!**

Please place your order with your regular radio parts jobber. If your local jobber cannot supply you, kindly write for a list of jobbers in your state who do distribute our instruments or send your order directly to us.

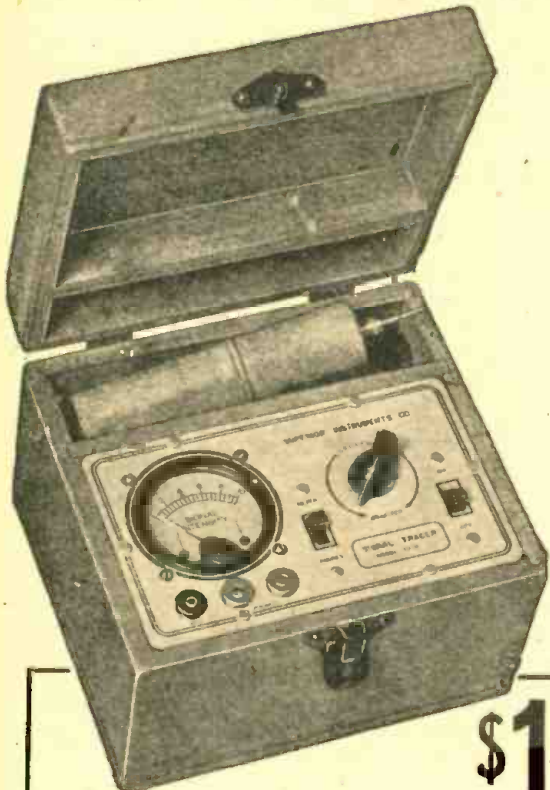

## The New Model CA-11 SIGNAL TRACER

Simple to operate . . . because signal intensity readings are indicated directly on the meter!

Essentially "Signal Tracing" means following the signal in a radio receiver and using the signal itself as a basis of measurement and as a means of locating the cause of trouble. In the CA-11 the Detector Probe is used to follow the signal from the antenna to the speaker — with relative signal intensity readings available on the scale of the meter which is calibrated to permit constant comparison of signal intensity as the probe is moved to follow the signal through the various stages.

### Features:

- ★ SIMPLE TO OPERATE — only 1 connecting cable — NO TUNING CONTROLS.
- ★ HIGHLY SENSITIVE — uses an improved Vacuum Tube Voltmeter circuit.
- ★ Tube and resistor-capacity network are built into the Detector Probe.
- ★ COMPLETELY PORTABLE — weighs 5 lbs. and measures 5" x 6" x 7".
- ★ Comparative Signal Intensity readings are indicated directly on the meter as the Detector Probe is moved to follow the Signal from Antenna to Speaker.
- ★ Provision is made for insertion of phones.

**\$18<sup>75</sup>**

The Model CA-11 comes housed in a beautiful hand-rubbed wooden cabinet. Complete with Probe, test leads and instructions. . . . . Net price

## The New Model 450 TUBE TESTER

### Specifications:

- Tests all tubes up to 117 Volts including 4, 5, 6, 7, 7L, Octals, Locals, Bantam Junior, Peanut, Television, Magic Eye, Hearing Aid, Thyratrons, Single Ended, Floating Filament, Mercury Vapor Rectifiers, etc. Also Pilot Lights.
- Tests by the well-established emission method for tube quality, directly read on the scale of the meter.
- Tests shorts and leakages up to 3 Megohms in all tubes.
- Tests individual sections such as diodes, triodes, pentodes, etc., in multi-purpose tubes.
- New type line voltage adjuster.
- NOISE TEST: Tip jacks on front panel for plugging in either phones or external amplifier will detect microphonic tubes or noise due to faulty elements and loose internal connections.
- Works on 90 to 125 Volts 60 Cycles A.C.



**SPEEDY OPERATION** assured by newly designed rotary selector switch which replaces the usual snap, toggle, or lever action switches.

The model 450 comes complete with all operating instructions. Size 13"x12"x6".  
Net weight 8 lbs. **\$39<sup>50</sup>**  
Our Net Price. . . . .

## The New Model 670P SUPER-METER

A Combination Volt-Ohm Milliammeter plus Capacity Reactance Inductance and Decibel Measurements.

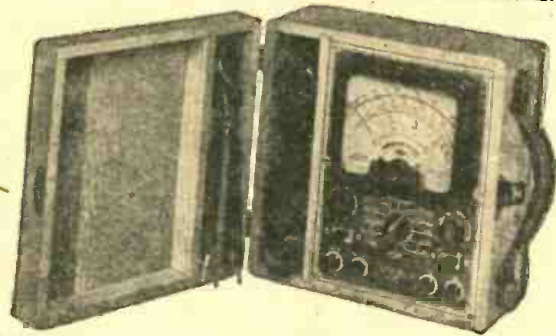

Specifications:  
D.C. VOLTS: 0 to 7.5/15/75/150/750/1,500/7,500 Volts.  
A.C. VOLTS: 0 to 15/30/150/300/1,500/3,000 Volts.  
OUTPUT VOLTS: 0 to 15/30/150/300/1,500/3,000 Volts.  
D.C. CURRENT: 0 to 1.5/15/150 Ma. 0 to 1.5 Amperes.  
RESISTANCE: 0 to 500/100,000 ohms; 0 to 10 Megohms.  
CAPACITY: .001 to .2 Mfd., .1 to 4 Mfd. (Quality test for electrolytics).  
REACTANCE: 700 to 27,000 Ohms, 13,000 Ohms to 3 Megohms.  
INDUCTANCE: 1.75 to 70 Henries; 35 to 8,000 Henries.  
+30 to +58.  
DECIBELS: -10 to +18; +10 to +38;

### Added Feature:

The Model 670P includes a special GOOD-BAD scale for checking the quality of electrolytic condensers at a test potential of 150 volts.

The Model 670P is housed in a hand-rubbed, portable oak cabinet complete with cover, test leads and all operating instructions.

**\$35<sup>75</sup>**  
Net



**SUPERIOR INSTRUMENTS CO.**

Dept. RC 227 FULTON ST., NEW YORK 7, N. Y.



# A Salute to Dr. Lee de Forest

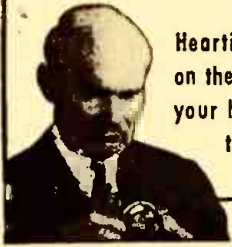

Heartiest congratulations on the 40th Anniversary of your historic invention—the 3-element Audion.

## OHMITE Little Devil INSULATED COMPOSITION RESISTORS



Resistance and Wattage marked on EVERY UNIT

Here is a new composition resistor—tiny but exceptionally rugged. Not only color coded, but individually marked for quick identification. *Little Devils* are sealed and insulated by molded plastic. They dissipate heat rapidly, have a low noise level and low voltage coefficient, are light, compact, and easy to install. Millions of these units have proved their value in critical war equipment. Available from stock in Standard RMA values from 10 ohms to 22 megohms. Tolerance  $\pm 10\%$ .

Available only from Ohmite Distributors

Send Now for  
Bulletin No. 127  
OHMITE MFG. CO.  
4894 Flournoy Street  
Chicago 44, Illinois



Be Right with...

# OHMITE

RHEOSTATS  
RESISTORS • TAP SWITCHES

# WORLD-WIDE STATION LIST

Edited by Elmer R. Fuller

**M**ERRY CHRISTMAS and Happy New Year! And we hope that you got that new receiver you were wishing for! We didn't wish for anything here and were not disappointed. Well, here we are starting another new year with yours truly, and hoping to make good again this year. To start off with, I'll give you a little advance dope on what will be in the February issue. We are going to stick our necks out by using a different time system than in the past. This will be based on the twenty-four hour clock like Greenwich time, but will be given in Eastern Standard Time. Thus, midnight will be 0000, noon will be 1200, 6 p.m. will be 1800 and so on. This will eliminate any confusion as to a.m. and p.m. We hope it will be adopted by all of our readers. After you see and use it, we would like to have your comments on it.

Starting soon after the turn of the new year, we will have something special for our regular observers. This will be announced through the mails to each one. This is the time to apply for your Observers Listening Post certificates as new ones will be mailed about the end of January. If you wish an appointment for 1947, drop me a letter and tell me of your intentions. The address again, is Elmer R. Fuller, Short Wave Editor, Radio-Craft, 25 West Broadway, New York, 7, N. Y.

JCKW is now heard on 7.220 megacycles from 1100 (11 a.m.) to 2130 (9.30 p.m.) hours EST. It is located in Palestine, and is usually heard relaying the BBC programs. The news in English is given at 0700, 1400, and 2000 hours (7 a.m.; 2 and 8 p.m.) and the "Radio Newsreel" at 1800 hours. This information was sent to us by Bill Dugan who is our observer from Goshen

N. Y. At the present time Bill is aboard the S-S *Cape Elizabeth* on a voyage to the Near East, India, and Ceylon. The report came to us from Keamari, India. Many thanks, Bill.

Paris, France is now being heard daily on 9.550 and 11.845 megacycles at 0900 to 0930 in English, 0930 to 1000 hours in French; 1000 to 1030 hours with a variety program, and 1030 to 1045 hours in English to the Pacific. Reports are requested and may be sent to *French Radio*; 14 East 53rd Street, New York, 22, N. Y. KU5Q on Guam is now using the following frequencies: 7.645, 9.140, 9.280, 9.330, 9.670, 13.360, 15.920, 17.820, and 18.050 megacycles. FG8AA in Point-a-Pitre Guadeloupe, is being heard on the west coast on 5.960 megacycles from 1130 to 1245 hours. ZRH in Johannesburg, South Africa, is being heard on 6.029 megacycles from 2345 to 0130 hours. On Saturdays only, VLC9 is heard on 17.840 megacycles from 2010 to 2030 hours, EST. ZAA in Albania is heard on 7.850 with the news in English at 1600 hours EST. Beirut, Lebanon is heard on 8.110 megacycles from 1345 to 1505 hours EST.

A station in Scotland has been heard testing on 14.380 megacycles several times. They also shift their frequency from 14.300 to 14.500 megacycles. HSPP in Bangkok, Siam, is being heard on the west coast on 5.990 megacycles from 0600 to 0930 hours EST.

A letter was received recently from a reader in New Zealand who would like to correspond with dx'ers in this part of the world. So if you wish to correspond with him, drop your Shortwave Editor a card, and I will forward his address to you. I am sure that you will be well paid for your time. Well, until next month, 73!

All schedules in Eastern Standard Time

Freq.	Station	Location and Schedule	Freq.	Station	Location and Schedule
9.958	HCJB	QUITO, ECUADOR: afternoons and evenings.	11.650	XTPA	CANTON, CHINA: 7 to 9:15 am.
10.000	WWV	WASHINGTON, D.C.: U. S. Bureau of Standards; frequency, time and musical pitch; broadcasts continuously day and night.	11.680	CMCY	HAVANA, CUBA: afternoons and evenings.
10.000	XGOL	FOOCHOW, CHINA: 5 to 9 am; 11:30 pm to 1 am.	11.680	GRG	LONDON, ENGLAND: Far East beam, 7 to 9 am; Northwest Pacific beam, 7 to 9:30 am.
10.220	PSH	RIO DE JANEIRO, BRAZIL: evenings.	11.690	XGRS	SHANGHAI, CHINA: 10:15 am to 11:30 am.
10.400	YPSA	SAN SALVADOR, EL SALVADOR: heard evenings.	11.696	HP5A	PANAMA CITY, PANAMA: 7 am to 11 pm.
10.420	VLN	BYDNEY, AUSTRALIA: around 12:15 am.	11.700	GVW	LONDON, ENGLAND: Southwest Pacific beam, 1 to 5 am; Indian beam, 11 pm to 1 am; South African beam, 10:30 am to 4 pm; Near East beam, 1 to 4 pm.
10.450		MOSCOW, U.S.S.R.: midnight to 2 am; 9:30 to 10 am.	11.705	SBP	STOCKHOLM, SWEDEN: 8 to 9 pm; 1:45 to 2:15 am; 6 to 7 am.
10.510	KUIG	GUAM: heard calling NBC around 5:30 pm.	11.705	CXA19	MONTEVIDEO, URUGUAY: 8 to 9 pm.
10.730	VQ7L0	NAIROBI, KENYA: 9 am.	11.705	CBFY	VERCHERES, CANADA: 10 am to 11 am.
10.780	SDB2	STOCKHOLM, SWEDEN: 3:15 to 5 pm.	11.710	WLWS2	CINCINNATI, OHIO: 4:45 pm to 1 am.
11.040	CSW6	LISBON, PORTUGAL: Brazilian beam, 12:30 to 3 pm; 4 to 6 pm.	11.710	WLWK	CINCINNATI, OHIO: European beam, 7:30 am to 4:30 pm.
11.090		PONTA DEL GADA, AZORES: 5 to 4 pm.	11.710	VLG3	MELBOURNE, AUSTRALIA: 1 to 2:45 am.
11.115	MCH	LUXEMBOURG: heard with Army Hour for New York.	11.715	HE15	BERNE, SWITZERLAND: 6:30 to 8 pm except Saturdays.
11.145	WCBN	NEW YORK CITY: European beam, 1 to 5:45 pm.	11.718	CR7BH	MARQUIS, MOZAMBIQUE.
11.595	VRR4	JAMAICA, BRITISH WEST INDIES: heard at 10 am.	11.718		KIEV, U.S.S.R.: North American beam, 6:20 to 9:15 pm.
11.616	COK	HAVANA, CUBA: 11 am to 11 pm.	11.720	PRL8	RIO DE JANEIRO, BRAZIL: heard at 5 am.
11.640	PY2	MANILA, PHILIPPINES: 6:30 to 7:15 am; evenings.	11.720	CKRX	WINNIPEG, CANADA.
11.630		MOSCOW, U.S.S.R.: 7:30 to 10 pm.			(Continued on page 94)
11.645		BRUSSELS, BELGIUM: evenings about 7:30 pm.			





CBS PHOTO

**TELEVISION - ITS HERE!**

(Quoting—Television Broadcasters Association)

**Here's Your Opportunity to "Get In on the Ground Floor" and Prepare for Great Opportunities Ahead**

**NOW—For the First Time, CREI Offers  
A Complete, Streamlined Home Study Course in  
PRACTICAL TELEVISION ENGINEERING**

Here is the basic, practical type of engineering training that will qualify you for a "key" job in the expanding Television industry. Sooner or later you *must* face Television—as a problem, or as an opportunity. You can't rest on your past radio experience. But, you can use it

as a firm foundation upon which you can add greater knowledge and ability with the help of this new CREI home study course. It costs you nothing but a few minutes' time to get complete details. Write at once for **FREE DETAILS** of the Television Engineering Course.

**CAPITOL RADIO ENGINEERING INSTITUTE**

16th and Park Road, N. W.

Dept. RC-1,

Washington 10, D. C.

**JUST OFF THE PRESS!**

**MAIL COUPON for Complete Free  
Details and Outline of Course**

If you have had professional or amateur radio experience and want to prepare for opportunities in TELEVISION, let us prove to you we have the training you need to qualify. To help us intelligently answer your inquiry—PLEASE STATE BRIEFLY YOUR BACKGROUND OF EXPERIENCE, EDUCATION AND PRESENT POSITION.



CAPITOL RADIO ENGINEERING INSTITUTE RC-1  
16th and Park Road, N. W., Washington 10, D. C.

Please send me complete details describing the new CREI home study course in Practical Television Engineering. I am attaching a brief resume of my experience, education and present position.

Name .....

Street .....

City ..... Zone ..... State .....

CHECK  PRACTICAL RADIO ENGINEERING COURSE  PRACTICAL TELEVISION ENGINEERING

I am entitled to training under the G. I. Bill.

Member of NATIONAL HOME STUDY COUNCIL—NATIONAL COUNCIL of TECHNICAL SCHOOLS—and TELEVISION BROADCASTERS ASSN.  
RADIO-CRAFT for JANUARY, 1947



# THE MASTERS CHOICE!

## SUPREME MODEL 504B TUBE AND SET TESTER

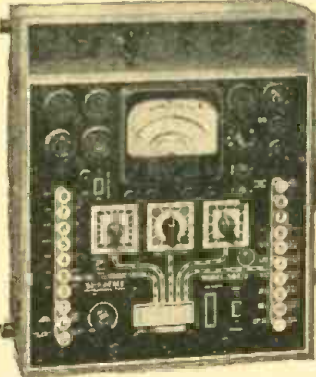

Any craftsman distinguishes himself by the appearance of his tools and equipment. For 19 years SUPREME equipment has identified thousands of successful radio service engineers. SUPREME equipped repair shops distinguish themselves for their professional appearance, dependability, and profitable operation.

One among the complete group of SUPREME radio testers is the Model 504B Tube and Set Tester.

- **METER**— large 4-inch square-face meter, 500 microampere.
- **SPEED**— push-button operated.
- **FLEXIBLE**— simple, yet Universal Floating Filaments feature insures against obsolescence.
- **SIMPLICITY**— roll chart carries full data for tube setting. No roaming test leads when using multi-meter—only push a button.

### SPECIFICATIONS

DC VOLTS — 1000 Ohms per volt: 0.5-25-100-250-500-1000-2500.  
AC VOLTS — 0.5-10-50-250-1000.  
OUTPUT VOLTS, 0.5-10-50-250-1000.  
OHMMETER, 0-200-2000-20,000 Ohms  
0-2-20 Megohms

### Condenser Check:

Electrolytics checked on English reading Scale at rated voltages of 25-50-100-200-250-300-450 volts.

### Battery Test:

Check dry portable "A" and "B" batteries under load.

# SUPREME

SUPREME INSTRUMENTS CORP.  
GREENWOOD, MISS.  
U. S. A.



"SUPREME BY COMPARISON"

See the complete SUPREME line. Write for new SUPREME catalogue No. 446.

## WORLD-WIDE STATION LIST

(Continued from page 92)

Freq.	Station	Location and Schedule
11.720	OTC	LEOPOLDVILLE, BELGIAN CONGO: 6:30 to 7:30 am.
11.725	JVW3	TOKYO, JAPAN: heard at 1 pm.
11.730	KGEI	SAN FRANCISCO, CALIF.: South-west Pacific beam, 1 to 4:45 pm.
11.730	WRUW	BOSTON, MASS.: European beam, 1 to 5 pm; Caribbean beam, 5:15 to 5:45 pm.
11.730	KGEX	SAN FRANCISCO, CALIF.: 2 to 4:45 am; 5 to 11 am.
11.730	WRUL	BOSTON, MASS.: 5:30 to 6 pm; 6:30 pm to 1 am.
11.730	GVV	LONDON, ENGLAND: Far East beam, 12 to 4:45 am.
11.740	COCY	HAVANA, CUBA: afternoons.
11.740	CEI174	SANTIAGO, CHILE: 7 am to 11:30 pm.
11.740	HVJ	VATICAN CITY: noon to 1 pm.
11.750	GSD	LONDON, ENGLAND: South African beam, 12:30 to 3 am; 10:30 am to 4 pm; West African beam, 1 to 3 am; South American beam, 4:15 to 10:15 pm; Central American beam, 4:15 to 9 pm; Mediterranean beam, 1 to 4 am; 6 to 10 am; 10:30 am to 2:30 pm; North African beam, 2 to 4 am; 6 to 10 am; 10:30 am to 4 pm.
11.760	VLG10	MELBOURNE, AUSTRALIA: 2:30 to 5 am; 5:30 to 8 am; 8:30 to 9 am.
11.765		ALGIERS: 6 am to noon.
11.770	KCBA	SAN FRANCISCO, CALIF.: South American beam, 11 pm to 1 am; 5 to 10:45 pm; Oriental beam, 1 to 4:45 pm.
11.770	VLA4	MELBOURNE, AUSTRALIA: 2 to 3:15 am.
11.780	HP5G	PANAMA CITY, PANAMA: day-times and evenings.
11.780		MOSCOW, U.S.S.R.: 9 to 10 am.
11.780	OIX3	LAHTI, FINLAND: 2:30 to 8 am; 6 to 7 am; 8:15 to 8:45 am; 1 to 5 pm; 5:45 to 6:15 pm; 8:15 to 8:30 pm.
11.785		BRUSSELS, BELGIUM: 5:30 to 6 pm; 8 to 8:15 pm.
11.780	WRUL	BOSTON, MASS.: 11 am to 5 pm.
11.790	KNBA	SAN FRANCISCO, CALIF.: Philippine beam, midnight to 3:45 am; South American beam, 5 to 11:45 pm.
11.800	I2J	TOKYO, JAPAN: 9 to 10 am.
11.810	WLWL1	CINCINNATI, OHIO: European beam; 6 to 7:45 am; 1 to 5:45 pm.
11.810	ZOJ	COLUMBO, CEYLON: 5 am to noon.
11.820	GSN	LONDON, ENGLAND: West African beam, 3 to 4 pm; New Zealand beam, 1 to 5 am; Australian beam, 1 to 5 am.
11.826	WCRC	NEW YORK CITY: European beam, 6 to 10:30 am.
11.830	WCRC	NEW YORK CITY: European beam, 10:15 am to 4:30 pm; South American beam, 5 to 11 pm.
11.830		MOSCOW, U.S.S.R.: 10 pm to 2 am; 6 to 8 am; 11 to 11:30 am; 6 to 7 pm.
11.835	CXA19	MONTEVIDEO, URUGUAY: 6 am to 10 pm.
11.835		ALGIERS: 12:30 to 3 am; noon to 6 pm.
11.835		PRAGUE, CZECHOSLOVAKIA: 12:30 to 4:30 pm.
11.840	CWQ	LONDON, ENGLAND.
11.840	VLG4	MELBOURNE, AUSTRALIA: midnight to 12:45 am.
11.840	VLC7	SHEPPARTON, AUSTRALIA: Tahiti beam 1 to 1:40 am.
11.845		PARIS, FRANCE: 8 to 9:45 pm; 10 to 10:45 pm; 11 to 11:45 pm; midnight to 3 am; noon to 5 pm; 5:30 to 7:30 pm.
11.847	WGEA	SCHENECTADY, NEW YORK: European beam, 6 am to 3:45 pm; Brazilian beam, 4 to 10:30 pm.
11.847	XMMA	SHANGHAI, CHINA: 8 to 9 am.
11.855		SINGAPORE, MALAYA: 8 to 9:30 am.
11.860		RANGOON, BURMA: 10 pm to 1 am; 2:15 to 3 am; 8:30 to 10 am.
11.870	WNBI	NEW YORK CITY: South American beam, 6:30 to 11 pm.
11.870	WOOC	NEW YORK CITY: 4:30 to 5:30 pm.
11.876		MOSCOW, U.S.S.R.: 6:20 to 7:30 pm.
11.880	LRR	ROSARIO, ARGENTINA: heard at 7:30 pm.
11.885		MOSCOW, U.S.S.R.: 6:45 to 8 am; 6:30 to 7:30 pm.
11.890	KWIX	SAN FRANCISCO, CALIF.: 2 to 9 am.
11.893	WNBI	NEW YORK CITY: European beam, 1:15 to 4:45 pm.
11.897	JVU3	TOKYO, JAPAN: 6:45 am to 12:30 pm.
11.900	XGOY	CHUNGKING, CHINA: Allied Forces in the Far East, 7 to 8 pm; Asia, 1 Australia, New Zealand beam, 5 to 5:30 am; East Russia beam, 5:30 to 6 am; Japan beam, 6 to 6:30 am.
11.900	CXA10	MONTEVIDEO, URUGUAY: 3:30 to 9 pm.
11.930	GVX	LONDON, ENGLAND: North American beam, 5 to 7 am; Far East beam, 11 pm to 4 am; Middle East beam, 12:15 to 2:30 pm.
11.950		MEXICO CITY, MEXICO: heard evenings.
11.960	HEK4	BERNE, SWITZERLAND: 4:30 to 5:15 pm.
11.970	FZI	BRAZZAVILLE, FRENCH EQUATORIAL AFRICA: 11 am to 8:20 pm.
11.995	CSX	LISBON, PORTUGAL: 8 to 10 am.
12.000	CEI180	SANTIAGO, CHILE: late afternoons.
12.070	CSW	LISBON, PORTUGAL: heard 1:30 to 3 pm.

(Continued on page 101)

**Resco Sound Systems**  
No Better Quality  
No Lower Prices

## READY TO HOOK UP

### MODEL PA-1

A completely assembled system, ready to hook up and use! Practical for use in office, plant, outdoors, etc. Don't miss this value!

### You Get:

- High Fidelity 14-Watt Amplifier
- 12" PM Speaker
- Crystal Microphone
- Wall Baffle
- 25 Ft. Speaker Cable and Connectors

Only **52<sup>95</sup>** Completely Assembled

## De Luxe Portable System

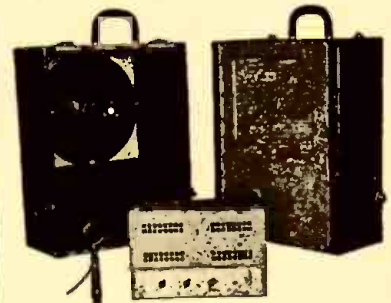

### MODEL PA-2

A complete portable system which includes high fidelity 14-watt amplifier; two 12" PM speakers; crystal microphone; de luxe carrying case; 25 ft. of speaker cable and connectors.

Only **\$75** Complete

## A Resco Value Scoop! RCA OUTDOOR SPEAKER

Designed and Engineered by RCA for the U. S. Navy for use on warships

Specifications: Magnet Weight—7 lbs. Rated voltage—30 watts. Voice Coil—8 ohms impedance, complete with output transformer for multiple use.



6 for \$84

**\$15** Each

Other Sound Systems Also Available... Write for Full Details.

**Radio Electric SERVICE CO. OF PENNA., INC.**

7TH AND ARCH STREETS, PHILA. 6, PENNA.  
Branches: 5133 Market St. and 3145 N. Broad St. in Phila.  
Also in Wilmington, Del., Easton, Pa., Allentown, Pa., Camden, N.J.





# ESSE Specials!



## WIRE WOUND VOLTAGE DIVIDER RESISTER

100 watt tapped at 3,000, 10,500, 10,523; 10,546, 11,296 ohms. With mounting clips.

Price, New ..... ea., **65c**



## Wire Wound Adjustable DIVIDER RESISTER

100-Watt, 5,000 Ohms  
Price, New ..... Ea. **85c**



## BL SELENIUM RECTIFIER TYPE 23751

Used for converting 110 V. AC to 110-135 V. DC at .75 amp. Voltage out is controlled by condenser across output. By connecting these units in parallel, any current output desired may be obtained.

Size 3 1/2" x 2 3/4" x 1 1/4".  
Price, New **\$1.25**

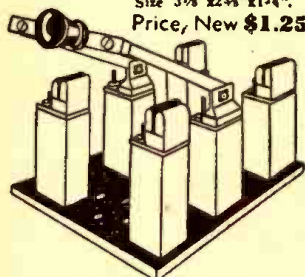

## ANTENNA SWITCHES

Double pole double throw. Size 8"x4"x2".

Price, New ..... **\$1.95** ea.

Same as illustrated except SPST. size 8"x4"x2".

Price, New ..... **\$1.00** ea.



## PE-103-A DYNAMOTOR UNIT ... BRAND NEW

Use to power your field or mobile transmitter. Input-6 V. DC. 21 Amps; 12 V. DC. 11 Amps. Output-500 V. DC. 160 MA. Filtered output, Hi-Current relay switches, and overload protect switches self contained in unit. Shipped in original overseas moisture-proof container. Wt. of unit 53 lbs.

Price, Brand New **Ea. \$13.95**

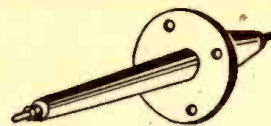

## TRANSMITTING FEED-THRU INSULATOR

Heavy porcelain with metal collar for fastening. Size 1 1/2" long, 3/4" dia. collar.

Price, New... ea., **\$1.50**

## Western Electric OIL-FILLED TRANSMITTING CAPACITOR

2 mfd. 2,500 Volts. Size 1 1/2" x 1 1/2" x 1 1/4"

Price, New, ea., **\$1.25**



## SPECIALS ... ALL NEW MERCHANDISE

Lo-loss Amphenol Tube Sockets, 4, 5, 6 and 7 prong, 15c ea.; Octal, 17 1/2c ea.; Acom, 35c ea.

## FILTER CONDENSERS—METAL CASED

MFD.	W. V.	MFR.	TYPE	PRICE
1,000	15 V.	C. D.	WP	42c ea.
1,000	25 V.	C. D.	WP	44c ea.
2	600 V.	Aerovox	Oil	75c ea.
4	1,000 V.	C. D.	T-10040G	\$1.39 ea.
8	1,000 V.	C. D.	TJH-10080-1	\$1.95 ea.
10	1,000 V.	Solar	Oil	\$4.75 ea.
2	2,500 V.	W. E.	Oil	\$1.25 ea.
1	3,000 V.	Industrial	Oil	\$2.75 ea.
1	4,000 V.	C. D.	TJH-40010G	\$4.75 ea.
1	4,000 V.	Sprague	Oil	\$5.75 ea.
1	5,000 V.	Aerovox	Oil	\$5.75 ea.
2	5,000 V.	C. D.	Oil	95c ea.
2	6,000 V.	C. D.	Oil	\$18.75 ea.
1	10,000 V.	Aerovox	Oil	\$21.50 ea.

## CERAMIC COIL FORMS

DIAMETER	LENGTH	NO. GROOVES	PRICE
2"	5"	34	15c
2"	3 3/4"	19	35c
1 1/2"	3 1/4"	45	25c
3/4"	9 3/4"	60	50c



## AN-30-B ANTENNA

Used on walkie-talkies and other portable radio equipment. Brass zinc plated. Length 13 1/2" collapsed, 105" extended, 9 sections. Screw base.

Ceramic insulated base for mounting AN-30-B on vehicle or other object. Price, New, **\$2.95** Ea.

Price, New... **50c** Ea.

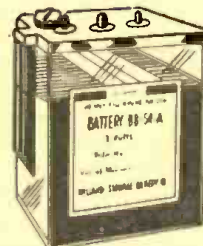

## WILLARD 2V. STORAGE CELL

Ideal for portable radios and replacement of dry cell installations. Shipped dry. BB-54-A is exact replacement for C. E. portables size 4"x3"x5 3/4".  
Price, new, **\$3.60** each.....



## CELL ILLUSTRATED AT RIGHT

Size 2 1/2" x 2 1/2" x 6 3/4".  
Price, new, **\$1.95** each.....

**TERMS:**  
CASH with ORDER  
or 25%  
BALANCE C.O.D.  
All Items  
Shipped Collect

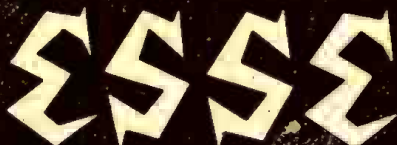

# Radio Company

130 W. New York St. Indianapolis 4, Ind.



Famous tank radio kit  
now available in Great  
Lakes Area.



f.o.b. Detroit **\$64.75**  
NET

*Mobile . . . . Marine*

# TRANSMITTER - RECEIVER

**for Amateurs • Experimenters • Radio Students • Schools**

Three large packing cases full of equipment includes:  
Two complete transmitters and two complete receivers covering  
the 2 to 8 megacycle and 235 megacycle bands. Also complete  
inter-com unit with three remote control stations, cable, connec-  
tors, extra head sets and push-to-talk microphones, all equipped  
with latest type dynamic units. . . . .

Also included: Dual voltage, completely filtered 12 volt dyna-  
motor, antenna resonator, extra antennas, 15 spare tubes in addi-  
tion to those included with set, spare parts, mounting brackets,  
hardware, blueprints, instructions, etc. NET \$64.75 F.O.B. Detroit,  
25% deposit on C.O.D. orders. (Orders from Michigan add 3%  
Sales Tax.) . . . . .

**HOOVER INDUSTRIES 9701 Bryden Avenue, Detroit 4, Mich.**

## REPLACING THE RECTIFIER

(Continued from page 64)

This resistor dissipates a little more than 5 watts so should be rated at 10 watts to allow a reasonable safety factor and cool operation.

Voltage for the pilot lamp may be obtained by any one of four methods. In Fig. 4 we have three alternate methods of lighting the pilot lamp: a,

a 117-volt pilot may be connected directly across the a.c. line; b, a single No. 47 bulb may be connected in series with an 800-ohm 15-watt resistor across the line. If two lamps are used, they are connected in series with a 775-ohm resistor across the line, c.

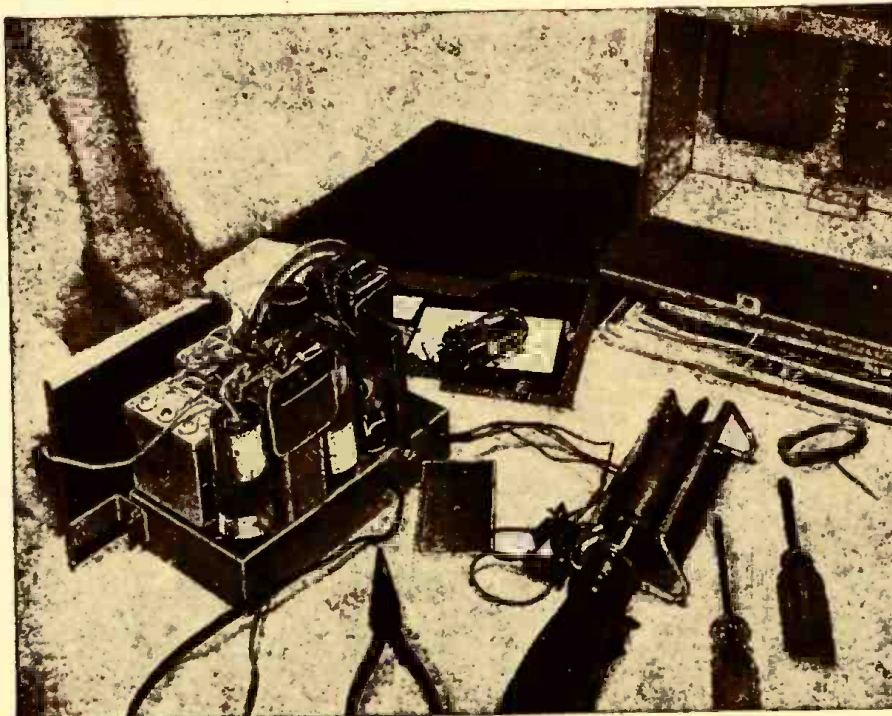

Photo B—Rectifier in place with one side of the protective cover mounted beside it.

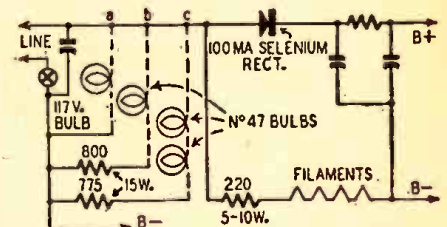

Fig. 4—How pilot-lamp voltage is obtained.

As an alternate, when the available space does not permit mounting large pilot lamp dropping resistors, the method shown in Fig. 5 may be used. Here, the filament dropping resistor is reduced to 200 ohms and a 20-ohm 1-watt resistor connected in the plate side of the a.c. line. A No. 47 lamp is connected across the resistor.

Two of these rectifier stacks may be connected into a compact voltage doubler power supply to provide bias for high power amplifiers and transmitters or B-plus voltages for a large receiver or a small transmitter.

(Continued on page 98)



# MICROWAVE PARTS AND EQUIPMENT

## TUBE SPECIAL

Tube Type	Approx. List	Your Cost
8BP1	\$15.00	\$3.85
8BP7	27.00	8.35
5BP1	20.00	4.85
5BP4	27.00	5.95
5CP1	45.00	4.95
5CP7	48.00	6.00
6FP4		4.85
5FP7	32.00	4.25
6JP2	48.00	13.60
837	2.80	1.50
872A	7.50	3.60
705A	22.50	7.50
241B-WB	85.00	50.00
861	155.00	95.00
2C40		5.95
2C43		8.95
Sockets for 5CP1; 3BP1. and similar types of tubes		\$.95

## RELAYS

**DPDT** 10a contacts, 115v/60 cps coil. Allied ..... \$1.59  
**SPST** 5a. ac; 115v cont. 115v/60 cps ..... 1.25  
**SPDT** contacts; coil rated 115v/60c .... 1.39  
**DPDT** 115v/60c. cont. rating 5a @ 50v. W. E. Co. .... 1.59  
**DPST** Telephone type; 2p. 1 cl; 1 open; cont. rating, 5a @ 50v. coil rating 3.5 ma (@ 12K ohms) 1000 vac .... 1.05  
**DPDT** Steatite Insulated Leach Relay 10 amp. silvered contacts ..... 1.95



## WESTON MICROAMMETER

Weston 0-20 microammeter. 54mv scale 0.20 Model 801. Brand ..... **\$4.50**  
 new!

## New Arc-5 Superhet Receivers

Tubes (included) 3—  
 12SK7; 1—12K8; 1—  
 12SR7; 1 12A6.  
 Range: 190-550 Kc;  
 Power: 24-28 VDC.  
 Remote control unit  
 and Dynamotor  
 and tubes. **\$32.50**

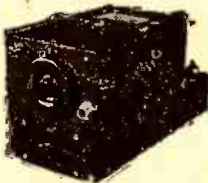

**ARC-5 Transmitters:** 25 watts CW; 15 watts phono. Tubes: 2-1625; 1-1629; 1-1626; 1 crystal. Range (Specify frequency desired): 5-.8 Mc; 8-1.3 Mc; 1.3-2.1 Mc; 4-5.3 Mc; 5.3-7 Mc; 7-9.1 Mc Power: 24-28 VDC. Remote control. Rack and plugs. Less dynamotor ..... **\$32.50**

Modulator unit; (with tubes) 1-1625; 1-VR150; 1-1215 ..... **\$12.00**  
 Transmitter-Dynamotor extra, new ..... \$16.00

## PULSE AMPLIFIER

Signal Corps type BC409. Designed for 115 volts. AC 60 cycles. Component parts worth several times the price of this unit. Slightly used. Following are a few of the items that make up the unit.  
 1—304TL, (Eimac)  
 3—2 mfd. 4,000 W.E. GE Pyranol condensers.  
 1—3200 volt. 150 MA power transformer.  
 1—Variac 5 amps. General Radio type CU 200.  
 1—5-volt. 26 Amp. fil. transformer (for 304 TL.)  
 1—2.5 volt. 10 Amp. fil. transformer 5000v insulation.  
 1—1 mfd. 1,000 volt, GE Pyranol. **\$59.50**  
 1—2 mfd. 1,000 volt, GE Pyranol.



## Ohmite Wire Wound Rheostats

Model H 250 ohms 25 Watt	.98
Model H 125 ohms 25 Watt	.98
Model J 1800 ohms 50 Watt	1.25
Model K 3000 ohms 100 Watt	1.98
Model L 100 ohms 150 Watt	2.25
Model L 250 ohms 150 Watt	2.25
Model N 22 ohms 250 Watt	3.00
Model P 1200 ohms 225 Watt	2.75

Other ratings in stock in ohmite Clarostat and Dejar. Inquire.



I-F Crystal filter for BC-312, BC-342. Resonant at 470 kc. Crystal included. **\$6.95**

## MAGNETRONS ! !

Westinghouse type 2J32 (JAN.) just released. This is the first large lot of MAGNETRONS to flow into the civilian market! The 2J32 is designed for 10 cm. operation.



Rated at 300 kw peak pulse power. Complete information supplied. Brand new, packed in individual protective cartons.

The 2J32 is listed at \$200.  
**OUR PRICE** ..... \$25.50  
 3J31's just received. One cm magnetron listed at \$95.00.

**OUR PRICE** ..... \$20.00

**KLYSTRON** oscillator tubes 2K25/723ab, designed for 3 cm. operation. New. Packed individually. Listed at \$38.00, reduced to ..... **\$ 7.75**

30 mc oscillator-amplifier with 2 6AC7's. Uses 723 n/b. Waveguide input, xtal detector. With 6AC7's ..... **\$10.00**  
 With 6AC7's and 723 a/b ..... **16.50**

Thermistor Beads (D-170396), for use with UHF and Micro-Wave Equipment (list @ \$3.00).

In separate sealed containers ..... @ .95

## 3 CM WAVE GUIDE SECTIONS

Silver Plated Directional Couplers with a 20 DB drop with:

- A. Straight wave guide section 6" @ \$3.95
- B. 15° bend in wave guide 15" ..... 5.90
- C. 30° bend in wave guide 10" long ..... 4.75
- D. 90° bend in wave guide 15" long also 90° bend in coupler ..... 6.50
- E. Six-inch section silver plated wave guide with 90° twist ..... 2.95
- F. 2 1/2 foot silver plated with 90° bend (2" radius) ..... 5.50
- G. 160° bend, with 90° twist 3 1/2 radius with pressurizing ripple and coax coupler ..... 3.95
- H. Straight section 2 1/2 ft. long, with choke coupling ..... 4.90

## RA-58-A Hi-Voltage Power Supply

Ideal for breakdown insulation testing, or as a source of power for a pulse transmitter. This unit supplies continuously variable voltages between 500 and 15,000 volts DC at 35 ma. A voltage Doubler circuit using two 705a rectifiers and two 1 mf condensers is employed. RMS ripple voltage at maximum power is 6%. **THIS UNIT OPERATES FROM 115 v/60c** Variable voltage is obtained by means of a Variac in the primary circuit of the high voltage transformer. Size is 21"x17 1/2"x29" deep. Net weight **\$116** 314 lbs. This unit sells for the low price of

**NEW POWER SUPPLY** for LM-18 freq. motor. Output: 290 v. at 20 ma; 13 v. at 600 ma. Input: 105-125v. at 60 cps; 260 ma; 27.6 W. type 84 rectifier tube; shock mounted. Complete with input and output cables tube included ..... **\$14.75**

## NEW USN NAVY MODEL RAK-7 SHIP RECEIVER

**\$69.95**

15 kc to 600 kc. 6-tube receiver with: AVC-Band pass filter—Audio filter—Noise limiter—Precision tuning with a Vernier dial—Voltage regulated power supply, with three tubes, for 60 cycle, 115 volts. Can be battery operated. Complete with spare parts box weighing 73 lbs., spare tubes and inst. book.

B-29 Computer Amplifier, containing 8-JAN6SN7 amplifier tubes, 1-6x5 GT, 8-relays, 5-neon glow lamps, completely wired amplifier circuit with many components. This fine amplifier was designed for use with remote-controlled guns. This buy sells for **\$14.75**  
 Low Voltage Power Supply for AN/APS-10, using 3-6x5 GT's, and 1-90D6, complete with 6 chokes, power transformer, and filter condensers. .... **\$6.50**

All merchandise guaranteed. Mail orders promptly filled. All prices F.O.B. New York City. Send Money Order or Check. Shipping charges sent C.O.D.

## COMMUNICATIONS EQUIPMENT CO.

131-C LIBERTY ST.,  
 NEW YORK CITY 7, N. Y.  
 WM 4-7658

## OIL FILLED CONDENSERS

500 mf 200 vdc .. \$1.95	15 mf 300 vdc .... \$ 1.95
2000 mf 50 vdc .. 2.00	1 mf 1000 vdc .... .90
4000 mf 30 vdc .. 2.25	2 mf 1000 vdc .... 1.10
1 mf 300 vdc .. .25	1 mf 1500 vdc ... 1.20
2 mf 300 vdc .. .30	4 mf 1500 vdc ... .30
4 mf 300 vdc .. .35	2 mf 680 ac/1000 .85
4 mf 400 vdc .. .35	1 mf 2000 vdc .... 1.00
1 mf 600 vdc .. .35	2 mf 4000 vdc .... 5.95
2 mf 600 vdc .. .40	1-1 mf 7000 vdc. 4.95
3 mf 600 vdc pyr .65	75 mf 20,000 vdc 22.00
4 mf 600 vdc pyr .70	G.E. Pyranol .06
6 mf 600 vdc pyr .95	mf 15,000 vdo
10 mf 000 vdc pyr 1.49	(List \$25.00) ..... 5.95

G.E. Pyranol 23F49 1 mf-5000v List \$27 ..... \$5.95  
 C-D TC-50010 1mf 5000v (list \$30) ..... 4.50  
 G.E. 14F191 .1 mf 10,000v (list \$37) ..... 6.75

## Sangamo Mica Condensers

F3L .0003 mfd 8000V list \$29.00 ..... **\$3.75**  
 F3L .0015 mfd 8000V list \$31.00 ..... 4.00  
 Solar type SX .0015 mf 3000V list \$9.95 .75  
 Sangamo G-4 .004 mf 20kv list \$110.00 25.50  
 Sangamo G-3 .006 mf 10kv list \$87.50.. 19.50

## SELSYN MOTORS

ideal for remote control, or for antenna rotation **\$7.75**



**AMERTRON PLATE TRANSFORMER** 115 v-60 cycle primary. 6200 volt-ct-700 mill secondary. Size 11"x14"x10". \$39.95  
 GHY. 700 M. A. CHOKES \$7.95. Can be used with Amertron Transformers. 1/4 WAVE RECTIFICATION 115v-60c/3200v 150 mls. MADE BY KENYON ..... \$9.95

## CHOKES

12hy-12 hy @ 150 ma., 15 amp. rating, each price ..... \$4.25  
 15 hy @ 165 ma 200 ohms DCR made by Jefferson. Price ..... 2.00  
 59 hy @ 100 ma 850 ohms DCR made by Jefferson. Price ..... 2.00  
 2.6 hy @ 800 ma stud and terminals at bottom ..... 5.00

## AUDIO TRANSFORMERS

Modulation xfmr: typical for 211's cl. A50W ..... \$1.85  
 Modulation xfmr: 807 to pr 807's ..... 1.35  
 Modulation xfmr: pr. 811's to 813 ..... 5.00  
 Input xfmr: single button to grid. 20:1 1.00  
 Audio output transformer Split pri. 1500 OHMS each side. Secondary impedance 85 ohms center-tapped -6:1 ratio. 100 watts output. .... \$7.50  
 Line to Voice coil transformer. Pri 600 ohms Sec 6 ohms. 1200 Test volt .... 1.75



Cardwell Split-Stator type PK-200-QD. 200-30 mmf per section. Special Hi-Volt with 2" spacing. .... \$9.95  
 Johnson type 500D35. 500-35 mmf. .08" spacing. (Listed at 11.75) \$4.75

## SPECIAL ITEMS

52 ohm co-ax types, RG-8/U, RG-9/U, RG-38/U @ .05 per ft. minimum order \$1.50  
 Tube shields for 2AP1 (and others of the same size) ..... 1.25  
 Transmitting key; 200 watt. .... .79  
 Hook-up wire, stranded, 100 ft. .... .95  
 Mycalex strips, 1/4"x3/4"x14 1/2", ea. .... .10  
 12 for \$1.00. Minimum order. .... .60  
 Hand generator type GN-45B. Output: 6v-3a/500v-14a, rated speed 60 cps... 5.95  
 Antenna loading coil, Heavy duty, with six (6) variable taps. 6 1/4" longx4 1/4".... 2.95  
 829 socket, ceramic ..... .95  
 Visor for 5" scopes. .... .75  
 Broadcast band push-button tuning units. Inductive, capacitive types. .... 2.98  
 Matched pair precision resistors, 6.33 mega. .... 3.00  
 Swinging Chokes: 2.5 hy @ 375 ma; 10 hy @ 75 ma ..... 3.95

**SILVER BUTTON MICA CONDENSERS** stud. mtg. (Eric/Centralab.) 175-180-185-245-335-360-365 mmfd 400 vdc. each ..... \$ .05  
 lots of 100 ..... 4.50  
 lots of 1000 ..... 37.50

minimum order \$1.00

**HANDSETS—WHILE THEY LAST!**  
 Famous TS-18—push-to-talk handset with 50-ohm mike and 200-ohm phone. 1 each PL-55 and PL-68. Selling brand new for ..... 5.95



# RADIO PARTS

## ELECTRONIC EQUIPMENT

### MONEY-SAVING VALUE

Concord has them! Radio & Electronic Parts, Supplies and Equipment of every kind, for every need... long-awaited, hard-to-get items... new merchandise, just received... Hundreds of bargains... in stock NOW for immediate shipment from CHICAGO or ATLANTA. Listed below are just a few of Concord's Money-Making Values in Top-Quality, Standard-Make Parts and Equipment. CHECK these offerings now - or write us your needs.

**IMMEDIATE SHIPMENT**



**ALNICO V 5\"/>**



**WELLS-GARDNER BC-348-N Communications Receiver**, 6 Bands—200-500 KC. and 115 MC. to 18 MC. in 5 Bands. 2 stages RF, 3 stages IF., Beat Frequency Oscillator, Crystal IF. Filter, Manual or Automatic A. V. C. Complete with tubes and 24 V. D. C. input dynamotor power supply, but supplied with complete instructions and diagrams for converting to 110 V. A. C. 60 cycle operation. **BC-348-N . . . \$53.95**

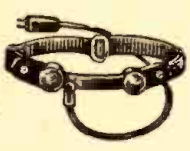

**CARBON THROAT MICROPHONE**  
 Will work into any 200 ohm impedance input circuit. Has adjustable strap to fit any neck. Ideal for ultra high frequency mobile work for hams. Supplied with strap, 10' cord and plug. **5B7060 . . . 49¢**



**3 Mfd. 4000 Volt Hi-Voltage Condenser**  
 Large 3 mfd., 4000 v. DC. condenser, hermetically sealed in an aluminum can. Size 4 1/2 x 3 1/16 x 7 1/4\"/>



**Supreme Model 543B 1000 O.P.V. A Sensitive Meter**  
 Has pin jack terminals, and includes the following ranges:— 0/6/60/600 D. C. M. A., 0/15/150/600/3000 V. A. C. and D. C., 0/2000/200,000 ohms. This meter is convenient to carry. Weighs 28 ozs. Uses full size 3\"/>



**D.C. MILLIAMMETERS**  
 2 1/4\"/>

### SAVE ON VALUES LIKE THESE

**A POPULAR HAM TUBE AT A REAL LOW PRICE**  
**9003 VHF Midget Super Control RF Pentode Tube** **95¢**

**HEAVY DUTY LINE FILTER**  
 Solar Elm-O-Stat. Completely shielded. Type EN106. **5B3218 Each \$1.79**

**NEUTRALIZING TOOL KIT**  
 12 tools Telescope into 5 units Composed of alligator side wrench—6\"/>

**WIRE STRIPPER**  
 Strips wire instantly! Fastens to bench or other support. Wire stripped to any length. Strips wire up to 12 MM diam. Each **98¢** **C15268**

**AERIAL WIRE**  
 Contains 7 strands—4 copper—3 of monel. 100 foot coils. **5B5133 . . . Each 29¢**

### CRESCENT AUTOMATIC RECORD CHANGER

Simple, single control, plays ten 12\"/>

**TUNER UNIT TU-10-B**. Continuous frequency range from 10 MC. to 12.5 MC. VFO oscillator tuning section, buffer, coupling, capacitors and choke, and buffer output matching tapped coil and condenser. Size 16 1/4\"/>

**T-17-B 200 Ohm Carbon Mike**. Lightweight, with press-to-talk button. Built-in filter to suppress carbon hiss. 5\"/>

**STANCOR Universal Output Transformer Type A3856**. Primary for all single or push-pull plates. Secondary adjustable from 1 to 80 ohms. Two-inch mounting centers. 4 watts at 85 mils. **C1675. SPECIAL . . . \$1.32**

**Mail the Coupon Below Now!**  
 for New Concord Bulletin of Radio Parts and Electronic Equipment. See 8 giant-size pages packed with Radio Needs—Condensers, Meters, Controls, Transformers, Switches, Relays, Tools, Amplifiers, Records, Players and Changers—new and scarce items—scores of bargains. **MAIL COUPON NOW!**

**Concord Radio Corporation**  
 901 W. Jackson Boulevard, Dept. RC-17  
 Chicago 7, Illinois  
 Please rush my **FREE COPY** of the new Concord Bulletin of Radio Parts.

Name \_\_\_\_\_  
 Address \_\_\_\_\_  
 City \_\_\_\_\_ State \_\_\_\_\_

**CONCORD**  
**RADIO CORPORATION**  
 LAFAYETTE RADIO CORPORATION  
 CHICAGO 7 ATLANTA 3  
 901 W. Jackson Blvd. 265 Peachtree Street

### REPLACING THE RECTIFIER

(Continued from page 96)

Using the circuit shown in Fig. 6, the voltage doubler will supply 285 volts at 20 ma and the voltage drops off to 255 volts when the load current reaches the maximum d.c. output of 100 ma.

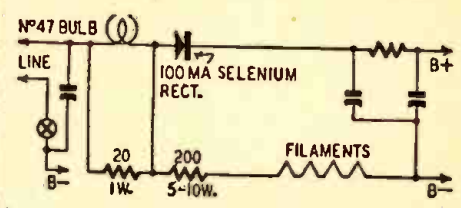

Fig. 5—Another pilot lamp connection method.

Three operational improvements have been achieved with the installation of this rectifier. In the first place since rectification is now immediate the set operates as soon as it is turned on in contrast to the filament warm-up period

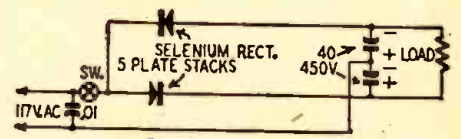

Fig. 6—The rectifier as a voltage doubler.

wait previously required. Secondly in view of the low internal impedance and high efficiency of the stack, the ambient temperature of the set is reduced by 36° F meaning increased battery life. Finally the long life of the selenium rectifier means that rectifier troubles have been reduced to a minimum.

### RADAR BEATS WEATHER

Ground-controlled approach, a radar system of landing planes, is credited by the Navy with making possible a trans-continental all-weather airway.

The Naval Air Transport Service has been flying a daily schedule between Patuxent, Md., and San Francisco for five months, with no flight cancelled because of unfavorable weather.

It is the further claim of the N. A. T. S. that no flight into Patuxent from anywhere has been canceled because of weather conditions there and that its flights to that base are dispatched "regardless of weather." This record is attributed to no superior flying skill on the part of Navy pilots, but to the fact that the N. A. T. S. is an all-out believer in and user of the radar "ground-controlled approach" (GCA) system of guiding aircraft down out of the skies to weather-obscured runways.

The C.A.A., according to the report, has already commenced installation of "experimental" GCA installations to supplement and serve as a check on their Instrument Landing System, equipment in which the C.A.A. had a long-standing and heavy investment—and to which many C.A.A. officials consequently feel they are committed. Work already is under way on the installation of a complete GCA system at La Guardia Field in New York.



# RADIO-CRAFT LIBRARY SERIES

## 5 New Books Just Out!

Each of the books in this new series is crammed full of meaty modern material for immediate, practical application. The books are all set in modern easy-to-read type, carefully printed and well illustrated. 64 pages, durable, flexible cover in colorful modern design. Price 50c each post paid.

### No. 29

**HANDY KINKS AND SHORT CUTS.** A compilation of practical expedients and methods of overcoming difficulties encountered by every radio man, suggested by readers of RADIO-CRAFT. Here are kinks on antennas, kinks on servicing, kinks for the shop, kinks on power supplies, etc.—arranged by sections for easy reference, and illustrated.

### No. 30

**UNUSUAL PATENTED CIRCUITS 1944-1946.** A digest of electronic patents, many the result of wartime research, valuable both to the experimenter and to anyone in the electronic field. Divided into five sections: Control Circuits; Power Supplies; Detectors and Amplifiers; Miscellaneous and Foreign Patents. Simplified circuit diagrams illustrate the text.

### No. 32

**ADVANCED SERVICE TECHNIQUE.** An up-to-date collection of information on specialized phases of servicing, appealing definitely to the advanced serviceman rather than the beginner. This book is not intended as a *course in advanced servicing*, but strictly a diversified library of ideas, methods, and procedures not likely to be found in other textbooks designed for the professional serviceman.

### No. 36

**RADIO TEST INSTRUMENTS.** Every radio man can use this latest book on building test equipment. The book places more emphasis on the practical side of constructing testers than on classroom theories. Among the instruments described are signal tracers, capacity meters, portable and bench multicheckers, signal generators, tube checkers and electronic voltmeters.

### No. 38

**HOW TO BUILD RADIO RECEIVERS.** Here is a book for the set builder. 18 modern receivers are described—a sufficient variety to appeal to practically every radio fan. The selection includes the following types: Short-wave, broadcast, v. h. f., portable, a.c.-operated, a.c.-d.c. and miniature. Complete coil winding information is given where necessary.

#### CUT OUT COUPON AND MAIL

**RADCRAFT PUBLICATIONS**

25 West Broadway  
New York 7, N. Y.

Gentlemen: Kindly send me the volumes of your RADIO-CRAFT LIBRARY (50c each, postpaid) which I have checked by number to the right. I enclose my remittance totaling

\$.....

Name .....

Address .....

ALL 5 BOOKS

No. 29

No. 30

No. 32

No. 36

No. 38

**50¢  
EACH  
POSTPAID**

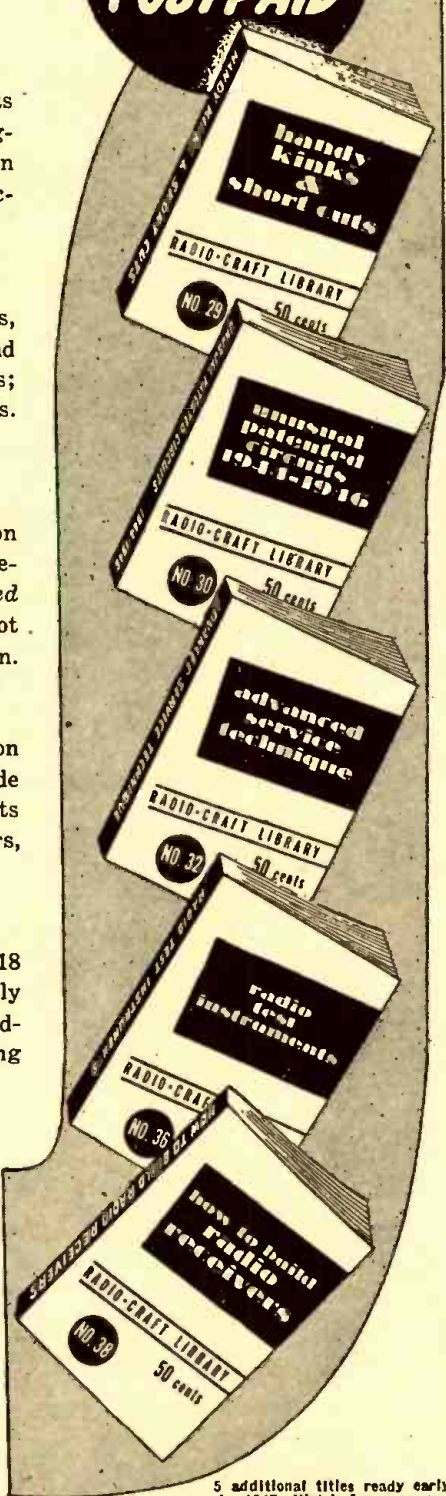

5 additional titles ready early in 1947. Watch for announcements in RADIO-CRAFT.



*Presenting*

# The E.M.C. Volometer\*

(trade name)

5 DC and 4 AC voltage ranges from 0 to 3000 V.  
Three current ranges. Four resistance ranges.

Resistances 1/20 ohm to 20 megohms. Low ohm scale is low drain back-up type. First ten divisions 1/20 ohm each.

AC volts 25 cycles to 1 megacycle. No external source of power required. Battery and rectifier replaceable without soldering iron. Matched-pair multiplier resistors accurate to 1%. 4 1/2" meter.



**MODEL 101 B (above)**  
**\$20.95**

For further information about this and other models, write us direct. For a conclusive demonstration, see your regular jobber.

Portable .....	\$24.95
Model 101 A .....	\$17.50
Same as above with 3" meters.	
Portable .....	\$21.50

**ELECTRONIC MEASUREMENTS CORP.**

114 Liberty St. • New York 6, N. Y.



**1907-1947**

We honor you, Dr. Lee de Forest on the occasion of the 40th Anniversary of your vacuum tube, the historic audion.

## SERVICE - Our Guiding Policy

- For nearly 20 years, Radio Parts Company has used as a watchword—SERVICE. We have felt and still feel that a company will grow and prosper according to the measure of service it provides for its customers.
- During the past war years, we did our level best to serve all equally in furnishing hard-to-get radio parts. We are proud of our record of seeing that radio service men, amateurs and others received the parts essential to their work.
- In the coming years, we pledge ourselves to continue serving the radio industry to the best of our ability. You can count on Radio Parts Company in the future, as in the past, for dependable parts at all times.

WRITE TODAY FOR OUR LATEST POST WAR CATALOG.

# RADIO PARTS COMPANY

612 W. Randolph St., Dept. C, Chicago, Illinois

## CABINET REFINISHING

(Continued from page 87)

in a dust-free atmosphere, or at least in a place where there is no movement to stir up dust.

Since the average radio man can usually employ himself more profitably at radio repair than as a woodworker, he may find it advisable to make an arrangement with a local furniture man or cabinet maker to handle any extensive cabinet refinishing job. One radioman submits an estimate for a complete cabinet refinishing job as part of the repair work in all cases where the cabinet is worn or shabby. He makes a slight profit on each job, which is done by a local cabinet maker, and benefits greatly by the enhanced reputation which his "looks-like-new" cabinets give him.

### METAL OR PLASTIC CABINETS

The methods shown above are for wood cabinets, but may be used for metal and plastic-type cabinets. If crack filler does not "stick" when applied, it may be fitted into the crack or opening and allowed to dry, then removed and cemented back in again, using a cement for glass or bakelite, rather than ordinary cement. Ordinary putty will often prove excellent in repairing cracks in bakelite cabinets, but the joint will show more or less and it is difficult to paint over the joint without leaving the paint raised above the surrounding bakelite surface.

For repairing broken cabinets, an excellent waterproof glue, made by mixing powder with cold water, is available under the name *Weldwood*. For plastic cabinets, special cements designed for the particular material must often be used. Many of these dry very quickly, so it is advisable that one person apply the cement while another has the clamps ready for quick use. These clamps are a necessity, as it is important that the surfaces be pressed firmly together to bond properly. A visit to any second-hand store that sells carpenters' tools should produce an old style wood clamp large enough for most cabinets.

Complete kits, containing shellac sticks, light and dark oil stain, metal shading lacquer, furniture polish and scratch remover, are available from large radio supply houses. For small jobs, the radioman will find one of these a great help to touch 'em up and take 'em out!

### HI-VOLTAGE FROM SPACE

Sun-spot activity which last spring played havoc with radio communication circuits throughout the world, produced some queer effects on wired circuits as well. Line communication systems were disturbed by the severe magnetic fields which induced unwanted currents in the lines. Eight hundred volts were induced on one telegraph line which normally carries 160 volts. The results: garbled messages or complete stoppage of the service.



# WORLD-WIDE STATION LIST

(Continued from page 94)

Freq.	Station	Location and Schedule
12.080	PST	RIO DE JANEIRO, BRAZIL; 6 to 7 pm.
12.080		MOSCOW, U.S.S.R.; 8 to 11 am.
12.095	GRF	LONDON, ENGLAND; Near East beam, 1 to 2:15 am; noon to 2:30 pm; Italian beam, 1 to 5 am; 6 to 10 am; 10:30 am to 4:15 pm.
12.110	H13X	CIUDAD TRUJILLO, DOMINICAN REPUBLIC; noon to 2:30 pm, 6 to 10:30 pm.
12.175		MOSCOW, U.S.S.R.; 6:45 to 7:45 am; 8:30 to 10:30 am; noon to 1 pm; 7 pm to 1 am.
12.180	LSN3	BUENOS AIRES, ARGENTINA; 6:15 pm.
12.210		VIENNA, AUSTRIA; afternoons 'at 4:30 pm.
12.250	WXFD	ALASKA; 8 pm to midnight.
12.255	KU5Q	GUAM; 5 am; 7 pm to midnight.
12.265		MOSCOW, U.S.S.R.; 4 to 5:30 pm; 8 to 9:30 pm; 10 pm to 6 am; 7 am to 1 pm.
12.265	TFJ	REYKJAVIK, ICELAND; 8 to 9 am; 3 to 6:30 pm.
12.270		HAVANA, CUBA; evenings.
12.445	HCJV	QUITO, ECUADOR; afternoons and evenings.
13.000	HDD	QUITO, ECUADOR; 2:45 to 3:30 am.
13.050	WNRI	NEW YORK CITY; European beam, 6 am to 6 pm.
13.050	KCBR	SAN FRANCISCO, CALIF.; Oriental beam, 10:15 pm to 1 am.
14.560	WNRX	NEW YORK CITY; European beam, 6 am to 3:45 pm.
15.000	WWV	WASHINGTON, D.C.; U. S. Bureau of Standards; frequency, time and musical pitch; broadcasts continuously day and night.
15.105		TOKYO, JAPAN; heard at 7:20 pm.
15.110	GWG	LONDON, ENGLAND; West African beam, 1 to 4 pm; Far East beam, 1 to 8:30 am; Southwestern Pacific beam, 1 to 5 am; Northwestern Pacific beam, 1 to 10:15 am.
15.110	HCJB	QUITO, ECUADOR; mornings and afternoons.
15.120	HVJ	VATICAN CITY; 8:30 to 9:30 am.
45.130	KGEI	SAN FRANCISCO, CALIF.; 5 to 7:45 pm; 8 pm to midnight.
15.130	WLWSI	CINCINNATI, OHIO; 0:45 am to 4:30 pm.
15.130	WRUW	BOSTON, MASS.; European beam, 6 to 8:45 am.
15.140	GSF	LONDON, ENGLAND; West African beam, 2:30 to 4:15 pm; Indian beam, 12:30 to 4 am; 5 to 10:15 am.
15.150	WRCA	NEW YORK CITY; 9 am to 4:30 pm; 5 to 6:45 pm.
15.150	KCBA	DELANO, CALIFORNIA; 4 to 11 am.
15.150	KNBX	SAN FRANCISCO, CALIF.; Oriental beam, 9 to 11:45 pm.
15.155	SBT	STOCKHOLM, SWEDEN; 6 to 7 am; 10 am to 1:15 pm; Sundays, 2:45 am to 1:15 pm.
15.160	JZK	TOKYO, JAPAN; heard at 7:30 pm.
15.170	TGWA	GUATEMALA CITY, GUATEMALA; daytime transmissions.
15.180	GSO	LONDON, ENGLAND; Italian beam, 6 to 10 am; Central American beam, 4 to 5:45 pm; Near East beam, 12:30 to 5 am; 6 to 10 am; 10:30 am to 2:30 pm.
15.190	CKCX	MONTREAL, CANADA; European beam, 7 am to 3 pm.
15.195	TAQ	ANKARA, TURKEY; 4:15 to 8 am.
15.200	WLWSI	CINCINNATI, OHIO; South American beam, 5 to 7:15 pm.
15.200	VLA6	MELBOURNE, AUSTRALIA; 3:30 to 8 am; 8:30 to 9:30 am; 4:15 to 6:30 pm; 9 to 11 pm.
15.200	W00C	NEW YORK CITY; European beam, 6 am to 3:15 pm.
15.210	KGEX	SAN FRANCISCO, CALIF.; Philippine beam, 5 pm to 1:45 am.
15.210	WB0S	BOSTON, MASS.; European beam, 6 am to 12:45 pm; 4 to 5:15 pm.
15.220	CHTA	MONTREAL, CANADA.
15.225	JTL3	TOKYO, JAPAN; 5:15 to 7:15 pm.
15.230	VL66	MELBOURNE, AUSTRALIA; 9 to 11 pm.
15.230	WLWL2	CINCINNATI, OHIO; North African beam, 6 to 7:45 am; 8 am to 12:45 pm; 1 to 5:45 pm.
15.230		MOSCOW, U.S.S.R.; 5:30 to 8:30 am; 9:15 to 9:30 am; 11 am to 1:30 pm.
15.240	KNBX	SAN FRANCISCO, CALIF.; Oriental beam, 3:45 to 8:45 pm.
15.250	WLWK	CINCINNATI, OHIO; South American beam, 5 to 7:15 pm.
15.250	WLWRI	CINCINNATI, OHIO; North African beam, 7:30 am to 3 pm.
15.260	GSI	LONDON, ENGLAND; South African beam, 10:30 am to 2 pm.
15.270	WCBX	NEW YORK CITY; European beam, 6 am to 3:45 pm.
15.270	KCBR	LOS ANGELES, CALIF.; Oriental beam, 4 to 10 pm; 10:15 pm to 1 am.
15.280	WNRE	NEW YORK CITY; European beam; 7:30 am to 4:15 pm.
15.290	WRUL	BOSTON, MASS.; 5 to 10:30 am.
15.290	KWIX	SAN FRANCISCO, CALIF.; 5:30 to 8:15 pm.
15.290	VUD3	DELHI, INDIA; 7 to 8 am.
15.300	GWR	LONDON, ENGLAND; Near East beam, 5 to 6 am; South American beam, 3 to 5:45 pm; Middle East beam, 12:30 to 1:45 am.
15.310	GSP	LONDON, ENGLAND; North American beam, 4:15 pm to 7:45 pm; 8 to 8:15 am; Australian beam, 1 to 5 am; New Zealand beam, 1 to 5 am.
15.315	HER6	BERNE, SWITZERLAND; Mondays, 8 to 3:30 am.
15.320		MOSCOW, U.S.S.R.; 5 to 11:30 am.

(Continued on page 102)

**RADIO STATION STANDBY**

**MOBILE RADIO UNITS**

**GEOPHYSICAL SURVEY**

**MUNICIPAL SIGNAL STANDBY**

**RAILROAD RADIO**

**AMATEUR RADIO**

**"SPOT" RECORDING**

# A.C. OR D.C.

## POWER

PORTABLE, STANDBY OR STATIONARY for Electronics Uses

Onan Electric Plants are completely self-contained, dependable power units built in a wide range of sizes and standard voltages.

Lightweight, one or two-cylinder, air-cooled models offer the maximum in portability for many applications. Portable A.C. models—350 to 3,000 watts; portable D.C. models—600 to 5,000 watts.

Although widely used for intermittent service as standby units, Onan two, four, and six-cylinder water-cooled plants are built for continuous heavy-duty operation... stationary or mobile. A.C. models—3 KW to 35 KW; D. C. models—3.5 KW to 10 KW.

WRITE FOR FOLDER

ONAN Electric Plants are available in many sizes and models. ALTERNATING CURRENT: 350 to 35,000 watts in all standard voltages and frequencies. DIRECT CURRENT: 600 to 10,000 watts, 115 and 230 volts. BATTERY CHARGERS: 500 to 3,500 watts; 6, 12, 24 and 32 volts.

**D. W. ONAN & SONS INC.**

2179 Royalston Ave.

Minneapolis 5, Minn.







# MAKES 90 OUT OF 100 RADIO TROUBLES Easy to Repair!

Complete, Easy Instructions for Repairing Common Troubles in Practically Every Model and Make of Radio in Use Today

**Eliminates Needless Testing — Enables You to Repair Two Radios in the Time Ordinarily Required for One**

**PAYS FOR ITSELF ON THE FIRST JOB!**

**TELLS WHAT TO DO EXACTLY HOW TO DO IT**

As valuable to a radio repair man as a recipe book is to a cook!

**\$5**

Ghirardi's **RADIO TROUBLESHOOTER'S HANDBOOK** (above) is the ideal book to have on hand for training new helpers, repairing either cheap or expensive sets quickly and profitably, eliminating needless test time and equipment—and **MAKING MORE MONEY.**



## ALL THE SCIENCE OF RADIO-ELECTRONIC SERVICING IN ONE GIANT BOOK

**LEARN AT HOME ... without an Instructor**

Alfred A. Ghirardi's **MODERN RADIO SERVICING** gives you a **COMPLETE, MODERN EDUCATION** in truly professional radio-electronic service methods of the kind that will be your "Open, sesame!" to the big-money opportunities that only well-trained servicemen are in a position to grasp. It is a complete, scientific servicing course from A to Z. You'll be surprised how easily understandable it makes every phase of the work even if you have had no previous service training. And, if you are already in the business, you'll be pleased to learn how this big 1300-page book will serve as a "refresher" course. Not only will it help you handle repair jobs quicker, better and more profitably, but it also will give you the necessary basic training to equip you for profitable industrial electronic work. Specifically written and designed for home study. 1300 pages; 706 clear illustrations. 720 Self-Test Review Questions make it easy for you to check your progress every step of the way. Fully indexed. Only \$5 on our famous 5-Day Money-back Guarantee.

**ENDORSED BY EXPERTS EVERYWHERE**

From beginning to end, **MODERN RADIO SERVICING** brings you the kind of modern professional "Know How" that will pay big dividends for years to come. Gives complete data on test instruments and their use. Preliminary trouble checks, scientific circuit analysis and trouble-shooting, parts repair and substitution, how to start and operate a successful service business and hundreds of other subjects.

### MONEY-BACK GUARANTEE

MURRAY HILL BOOKS, INC., Dept. RC-17, 232 Madison Ave., New York 16, N. Y.

Enclosed find \$..... for books checked; or  send C.O.D. (U.S.A. only) for this amount plus postage. I may return the books for refund within 5 days if not fully satisfied.

**RADIO TROUBLESHOOTER'S HANDBOOK** \$5 (\$5.50 foreign)

**MODERN RADIO SERVICING** \$5 (\$5.50 foreign)

**MONEY-SAVING COMBINATION OFFER:** Both of the above big books, only \$9.50 (\$10.50 foreign)

Name .....

Address .....

City & Dist. No. .... State .....

### SPECIAL OFFER!

Let **RADIO TROUBLESHOOTER'S HANDBOOK** save you time on common radio service jobs! Let **MODERN RADIO SERVICING** train you for complete professional, electronic work. Get **BOTH BIG BOOKS** at the special price of only **\$9.50 for the two. Send coupon today!**

### WORLD-WIDE STATION LIST (Continued from page 101)

Freq.	Station	Location and Schedule
15.325	JLP2	TOKYO, JAPAN; 11:45 pm to 4 am.
15.330	WGEO	SCHENECTADY, NEW YORK; European beam, 6 to 4:30 pm.
15.340	KNBI	SAN FRANCISCO, CALIF.; South American beam, 5 to 11:45 pm; Oriental beam 2 to 4:45 pm.
15.340	WRUA	MOSCOW, U.S.S.R.; 5:30 to 9:30 am.
15.350	WRUA	BOSTON, MASS.; European beam, 6 am to 4:15 pm.
15.350	GRE	PARIS, FRANCE; 6 to 8 am.
15.375	PZX5	LONDON, ENGLAND.
15.405	PZX5	PARAMARIBO, SURINAM; 12:30 to 1 pm.
15.450	GRD	LONDON, ENGLAND; African beam, 10:30 am to 2:30 pm.
15.505	CMA5	HAYANA, CUBA; 6:45 to 7:30 pm.
15.875	HE04	BERNE, SWITZERLAND; 2:15 to 2:50 pm.
15.595	FZ1	BRAZZAVILLE, FRENCH EQUATORIAL AFRICA; 4:45 to 8 am.
15.620	VRR0	JAMAICA, BRITISH WEST INDIES.
15.810	LSL3	Buenos Aires, ARGENTINA; heard mornings.
15.920	KU5Q	GUAM; 7 pm to midnight.
17.445	HVJ	VATICAN CITY; Wednesdays and Saturdays, 8:45 to 9:15 am.
17.527	FZ1	BRAZZAVILLE, FRENCH EQUATORIAL AFRICA; midnight to 2:30 am; 4:45 to 7:45 am; 11 to 5 pm.
17.700	GVP	LONDON, ENGLAND; Middle East beam, 1 to 5 am; 6 to 10 am; 10:30 am to 12:15 pm.
17.715	GRA	LONDON, ENGLAND; New Zealand and Australian beam, 2:30 to 5 am.
17.730	GVQ	LONDON, ENGLAND; Near East beam, 6 am to noon; Central American beam, noon to 4 pm; 6 to 8:30 am; Far East beam, 2 to 6 am; Indian beam, 2 to 5 am; Southwest Pacific beam, 2 to 5 am.
17.750	WRUW	BOSTON, MASS.; Central American beam, 8:30 to 8:15 pm; European beam, 9 am to 12:45 pm.
17.760	KWID	SAN FRANCISCO, CALIF.; South American beam, 5 to 7:30 pm.
17.765	OTC	PARIS, FRANCE; 6 to 8 am.
17.770	OTC	LEOPOLDVILLE, BELGIAN CONGO; 6 to 9:30 am; 11:30 am to 12:15 pm.
17.780	WNBI	NEW YORK CITY; South American beam, 5 to 6:15 pm; European beam, 7:80 am to 1 pm.
17.780	KNBA	SAN FRANCISCO, CALIF.; South Pacific beam, 2 to 4:45 pm.
17.790	GSQ	LONDON, ENGLAND; New Zealand beam, 2:30 to 5 am.
17.800	WLWO	CINCINNATI, OHIO; South American beam, 5 to 5:45 pm; European beam, 7:30 am to 2:30 pm.
17.800	KRHO	HONOLULU, HAWAII; Philippine beam, 4 to 11:30 am.
17.800	OIX5	LAHTI, FINLAND; 8 am to 12:30 pm.
17.810	GSV	LONDON, ENGLAND; South African beam, 1 to 4 am; Indian beam, 5 to 10:15 pm; West African beam, 2 to 4 am.
17.820	CKNC	MONTREAL, CANADA; European beam, 7 am to 2 pm.
17.830	WCBN	NEW YORK CITY; European beam, 8 am to 12:45 pm.
17.830	VUD10	DELHI, INDIA; 5 to 7 am.
17.845	VUD10	BRUSSELS, BELGIUM; 6 to 7 am; 11 am to noon.
17.850	KCBF	LOS ANGELES, CALIF.; South American beam, 5 to 10:45 pm.
17.870	GPP	LONDON, ENGLAND; Northwest Pacific beam, 1 to 5 am; 6 to 8:15 am; South African beam, 10:30 am to 12:45 pm.
17.955	WLW1	CINCINNATI, OHIO; European beam, 5 am to 12:45 pm.
18.025	GRQ	LONDON, ENGLAND; South African beam, 5 to 9 am; 10 am to 12:15 pm; West African beam, 5 to 9 am; 10 am to 2:30 pm.
18.080	GVO	LONDON, ENGLAND; North American beam, 8 am to 6:45 pm; South American beam, noon to 4:15 pm.
18.135	PMC	BATavia, NETHERLANDS INDIES; 11:30 am to 9:30 am.
18.160	WNRA	NEW YORK CITY; European beam, 6 am to 1:30 pm.
21.470	GSH	LONDON, ENGLAND; South African beam, 5 to 10:15 am; Near East beam, 5 to 10:15 am; West African beam, 5 to 10:15 am.
21.530	GSJ	LONDON, ENGLAND; Indian beam, 5 to 8:15 am.
21.550	GST	LONDON, ENGLAND.
21.640	GRZ	LONDON, ENGLAND; Central American beam, 8:30 to 10:15 am.
21.710	GVS	LONDON, ENGLAND; South American beam, 5 to 10:15 am.
21.750	GVT	LONDON, ENGLAND.
25.750	GSQ	LONDON, ENGLAND.
26.100	GSK	LONDON, ENGLAND; South African beam, 6:15 to 10:15 am; West African beam, 6:15 to 10:15 am.
26.400	GSR	LONDON, ENGLAND.
26.550	GSS	LONDON, ENGLAND.

### HAMS WORK AT RADIO

Amateur radio operators employed at the Kearny (N. J.) Works of the Western Electric Co. have recently conducted an informal census. *The Kearnygram*, published by W.E., lists 143 hams and their calls. They would like to know how this compares with the number of amateurs in other communications and electronics companies.



# CLIP-ON RADIO TESTER

By HOMER L. DAVIDSON

THE little clip-on tester described here is ideal for the radio beginner or servicemen. This small unit was built around a low-priced war surplus meter now found on the market. It is a Weston unit meter with a basic 0-1 ma meter movement.

Original feature of the tester is the clip, which is of the kind used to keep papers together. A heavy battery or photograph film clip would work as well or better. The clip is bolted to the bottom of the aluminum chassis of the tester and can be attached to the chassis of a set being checked, so the meter faces up toward the serviceman. Then he goes ahead with one probe to check the receiver.

It is best to use wirewound precision multiplier resistors for greater accuracy, although carbon resistors can be used. This meter has only two ranges, 0 to 100 and 0 to 500 volts d.c.

A s.p.s.t. toggle switch is used to switch one side of the voltmeter to ground or chassis as shown in Fig. 1.

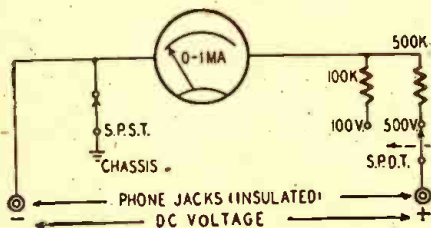
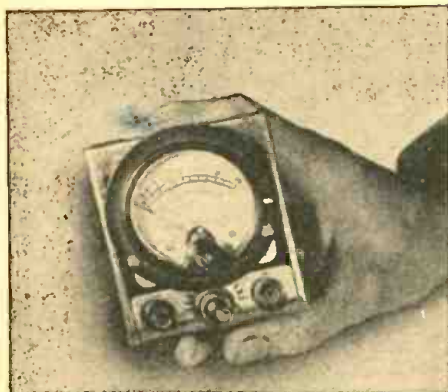

Fig. 1—Tester is a one- or two-lead device.

This switching method allows voltages to be measured from chassis to various positive voltage positions by flipping a switch. If the chassis is not the common negative connection the switch is thrown to the "off" position. Then two test leads are plugged into the common and other voltage phone plug, throwing switch 2 in the desired voltage range.



Main feature of the instrument is smallness.

The small chassis measures 3 by 5 inches and is cut from a thin sheet of aluminum. To fasten the clip-on tester to the chassis a large battery clip was secured and bolted onto the chassis with two 6-24 bolts. Later the clip shown in the photo was adopted as an improvement.

To operate the tester simply clip it  
(Continued on following page)



ALFRED A. GHIRARDI  
the man who has started  
thousands on successful  
careers by making Radio-  
Electronics easy to learn.

I'LL TRAIN YOU FOR  
**RADIO-ELECTRONICS**  
in a few short weeks  
FOR ONLY \$5 COMPLETE

## NO PREVIOUS TRAINING NEEDED... LEARN AS FAST AS YOU CAN READ

This single, fully-illustrated, 972-page RADIO PHYSICS COURSE book is a miracle of modern Radio-Electronic training—by an author who is famous throughout the world for making basic Radio-Electronics easy to learn. Actually, it is the equivalent of 36 complete courses in one. If broken into "course" form and sent in lesson style, you'd regard it as a bargain at \$50 or more. Instead, you buy it complete in book form for only \$5—and you progress as fast as you can read. Many students have completed it within a few weeks.

### COMPLETE—PRACTICAL—EASY TO LEARN

RADIO PHYSICS COURSE starts at the very beginning—with Basic Electricity. Then it guides you step by step through the entire field of RADIO-ELECTRONICS-TELEVISION to the latest, most modern developments. Nothing is omitted. Nothing is condensed. Everything is clearly and thoroughly explained. "I have read quite a few texts on Radio-Electronics," writes C. W. Redish of Astoria, Oregon. "Now, after reading RADIO PHYSICS COURSE, I can see that I wasted my time on the other ones!" Gerard Champagne of Montreal says that Ghirardi's RADIO PHYSICS COURSE at only \$5 explained things to him far better than a course for which he paid \$150!

Ask any successful Radio-Electronic man about RADIO PHYSICS COURSE. He'll know the book—because he probably got his start from it himself!

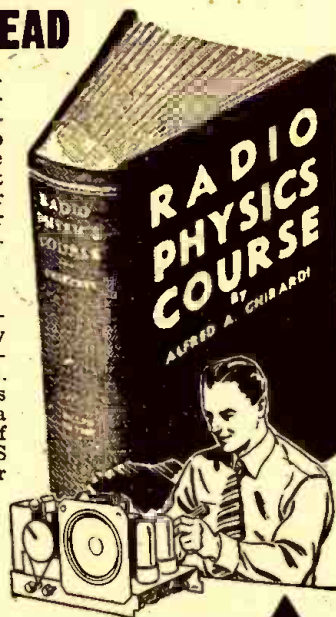

## THIS ONE BIG 3½ LB. BOOK DOES THE TRICK

... the same book that is more widely used for home study, by more Signal Corps, Navy, and civilian schools than any other book or course of its kind!

No matter what phase of ELECTRONICS-RADIO-TELEVISION work you plan to enter, a knowledge of basic fundamentals is absolutely essential. Ghirardi's world-famous RADIO PHYSICS COURSE gives exactly what you need—at a price you can afford to pay! Sound, Speech, Music, Electron Theory, Current, Circuits, Resistance, Measuring Instruments, Vacuum Tubes, Detector & Amplifier Tube Action;

Superhets; Amplifiers, Auto and Aircraft Radio; P.A. Systems; Sound Pictures and Television are but a few of the subjects covered. No previous electronic training is necessary to enable you to understand every word.

### WE GUARANTEE YOU'LL LIKE IT!

Remember! RADIO PHYSICS COURSE has given more beginners their start in this fascinating field than any other book or course ever published. Send coupon today! Read the book for 5 full days. Then, if not more than satisfied, return it — and we'll refund EVERY CENT of your money without question!



## ← LEARN ALL ABOUT ELECTROLYTIC CAPACITORS'

Want to know how to pick the right capacitor for a job? The advantages and applications of the different types at both high and low frequencies and voltages? How they are made? Their use on a-c or pulsating d-c? Ambient conditions, etc.? How to make measurements, tests, emergency repairs? Then send for Alexander M. Georgiev's "THE ELECTROLYTIC CAPACITOR" — the first book of its kind giving complete, modern data on this vital, widely used component. Fully illustrated. \$3 (3.25 foreign).

USE COUPON TO ORDER

## HAVE A LOOK! You be the judge!

MURRAY HILL BOOKS, INC., Dept. RC-17,  
232 Madison Ave., New York 16, N. Y.

Enclosed find \$5 (\$5.50 foreign) for which please rush my copy of Ghirardi's big 972-page RADIO PHYSICS COURSE book, or  
 send C.O.D. (in U.S.A. only) for this amount plus postage. If not more than satisfied, it is understood that I may return the book within 5 days of receipt for full refund of my money—and no questions asked.  
 \$3 enclosed (\$3.25 foreign) for a copy of Georgiev's THE ELECTROLYTIC CAPACITOR, or,  send C.O.D. (U.S.A. only) for this amount plus postage.

Name .....

Address .....

City & Dist. No. .... State .....

## 5-DAY MONEY-BACK GUARANTEE



# METROPOLITAN

Guarantees Delivery From Stock!

THE NEW MODEL B-45

## SIGNAL GENERATOR

Battery Operated

Self-modulated Signal Generator, providing a highly stable signal. Generates R.F. frequencies from 150 Kc to 12.5 Mc on Fundamentals and from 11 Mc to 50 Mc on Harmonics. R.F. is obtainable separately or modulated by the Audio Frequency. Complete with leads, batteries and instructions.

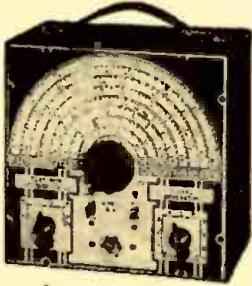

\$27.75



## New Model 670 SUPERIOR SUPER-METER

A Combination Volt-Ohm milliammeter plus capacity reactance inductance and decibel measurements  
NET .....\$28.40



## New Model 450 SUPERIOR TUBE TESTER

"Speedy Operation" assured by newly designed rotary selector switch which replaces the usual snap toggle or lever action switches.  
NET .....\$39.50

## CA-12 SIGNAL TRACER

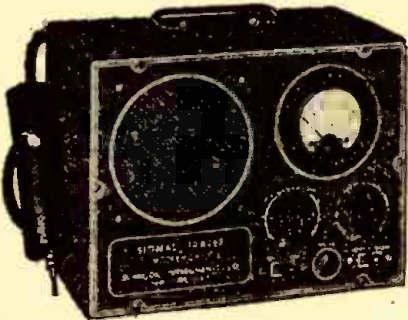

Now you can SEE and HEAR the signal. Simplest operation. Only one connecting cable—NO TUNING CONTROLS! Highly sensitive due to advanced Vacuum-Tube-Voltmeter circuit. Tube and resistor capacity network are built into the Detector Probe.  
Complete with probe, leads, batteries and instructions.

\$34.85

McMurdo Silver 905 "Spark" Signal Tracer... \$39.90  
McMurdo Silver 904 Capacit. Resist. Bridge... 49.90  
McMurdo Silver "Vomax" ..... 59.85  
SUPREME 543 Multi-Tester ..... 18.95  
SUPREME 589 Roll-Chart Tube Tester..... 48.95  
SUPREME 599 Roll-Chart Tube and Set Tester 62.50  
SUPREME 565 Vacuum-Tube-Voltmeter ..... 63.50  
SUPREME 576 Signal Generator ..... 68.95  
DuMont 5" Oscilloscope ..... 99.50

Write for FREE New 1947 Catalog

**METROPOLITAN**  
ELECTRONIC & INSTRUMENT CO.  
6 MURRAY ST., Dept. C1, NEW YORK 7, N.Y.

## CLIP-ON RADIO TESTER

(Continued from page 103)

onto your work and insert the test lead. If the chassis connection is common simply flip the switch to "on". A s.p.d.t. position switch is used to select the desired voltage range. Then throw this switch to the highest range first so that the unknown voltage will not be higher than the low-voltage range thus ruining the meter movement. This is one good thing to remember on any volt-meter.

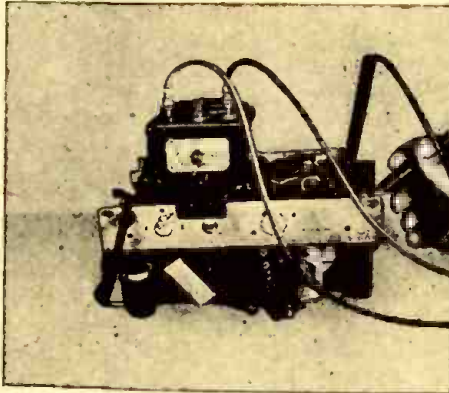

Tester in operation. Note switch on bottom.

By making the instrument only a little bigger a low voltage and an ohms range could be included. This would make it almost a perfect set for rough-and-ready testing. A milliamperage range would not be as useful, and if the tester is made too big it cannot be used as a clip-on.

	0-1MA	0-15MA	0-5MA
REQD VOLTS	REQD RES.	REQD RES.	REQD RES.
1	1000	667	2000
5	5000	3330	10000
10	10000	6670	20000
50	50000	33300	100000
100	100000	66700	200000
500	500000	330000	1MEG

Correct multiplier values for three meters.

The 1-milliamperage meter was used because it was easy to get. If this type of movement isn't handy, another one can be adapted by changing the resistor values according to Ohm's Law. A 1.5 milliamperage meter can be used by cutting the resistors to two-thirds of their value. (1/1.5) If you have a 500-microampere movement (0.5 ma) the resistors would have to be doubled (1/0.5) and for a 200-microamp movement they would have to be increased five times. The table shows multiplier resistors needed for common voltages and meter movements.

Fourteen radio stations and newspapers have bought or leased land for television sites atop California's 6,000-foot Mount Wilson, and sixteen other potential investors have investigated the spot.

Engineers state that transmitters on the mountain would have a line-of-sight range of 100 miles in all directions.



# WHOLESALE RADIO-ELECTRONICS PARTS DISTRIBUTOR

## BRUNO HOLE CUTTER KIT

Kit No. 790 consists of two Bruno expansion cutters, one No. 100 for holes 5/8" to 1 1/2" and one No. 101 for holes 1" to 2 1/2". Complete size range for cutting clean circular holes in sheet metal, wood, plastics, etc. Operate efficiently in a bench drill, drill press, or portable drill. Expertly made from high grade heat-treated steel. Ideal for use in home workshop or factory. For plumbers, electricians, carpenters, radio repairmen, etc. A "must" in every tool chest. (See page 57 for listing of individual cutters.) Shipped in attractive display carton. 3 lbs. ....\$7.85

## UNGAR SOLDERING PENCIL

Light soldering pencil draws only 17 watts. Heats in 90 seconds. Choice of five interchangeable tips. 7" long.

Solder Pencil. No. 776 with-copper \$1.45  
tip No. 536. NET .....  
776 Cord and Pencil only  
NET .....  
.536 Standard Tip. NET.....  
.537 Pencil Tip. NET..... **80c**  
.538 Chisel Tip. NET.....  
.539 Chisel Tip—Extra hot.....  
.277 Brass Tip for plastics.....

## HAND DRILL

Hand drill with hardened steel chuck takes drills up to 1/4" dia. Solid metal frame. Lacquer finished hardwood handle is designed for storing extra drills  
NET .....YOUR COST.....\$1.50

## JFD DIAL BELT KITS

Moisture-proof woven-fabric dial belts. Will not stretch. Especially treated to provide maximum friction. Kit of 25 contains one each of the most popular numbers; kit of 100 includes 90 different types to fit over 900 sets. Each kit comes with sturdy steel cabinet, belt scale and JFD book of belt and ballast replacement data for over 1100 standard radio sets. 60-456, 5 lbs. ....\$3.97  
25 Assorted. NET .....

MAIL ORDERS FILLED PROMPTLY



509 ARCH STREET  
PHILADELPHIA 6, PA.  
LOmbard 3-0513



# TECHNOTES

## RECORD CHANGER NOTES

One of the chief difficulties in servicing automatic record changers is in making adjustments on the under side of the mechanism.

I have overcome this problem by suspending the changer from the ceiling by means of wires and springs, as illustrated. This method speeds the work considerably.

I have a radio with the entire r.f. section badly damaged. The a.f. section is in good shape and I keep this set close at hand and use it for checking the performance of the pick-up.

M. W. HATLEY,  
Shawnee, Oklahoma

## PHILCO 50S

A frequent complaint on this model is fading accompanied by distortion. This trouble was found to be caused by the 1-megohm resistor in the grid return circuit of the 75 tube. This resistor changes value after the set has been in operation for a short time. Replacement with a good resistor of the required value will cure the trouble.

CLAUDE M. PREW  
New London, N. H.

## PHILCO 42-1006

The complaint was distortion and hum. When the antenna was removed from the set, the hum disappeared. I soon found that the speaker field was supplied by one-half of the 50Y6 rectifier. Filtering for the field is supplied by a 15-ohm resistor in series with a 10- $\mu$ f, 150-volt condenser. This condenser had shorted and burned out the resistor so that there was no "short" indication from cathode to ground. The open filter circuit was not evident in the absence of voice coil excitation because of the low voltage.

WALTER WESTERGREEN,  
Muskegon, Michigan

## GE E72

Frequently these sets are brought in with the complaint that the volume is low and unaffected by the volume control. The trouble is usually caused by a burned out 6H6.

The output transformer on this model opens frequently resulting in a "dead" set. When a 6F6-G is used, the trouble is spotted readily by the red-hot screen grid.

CHARLES McCLESKEY,  
Baton Rouge, La.

## PHILCO 42-350

This model often develops an intermittent which results in slight loss in volume. The screen bypass of the second i.f. stage is often the cause of this trouble. Oddly enough, this condition is not always detected by tapping the condenser. Replacement is recommended in all questionable cases.

McCLESKEY RADIO CO.,  
Baton Rouge, La.

# HARRISON HAS IT! — COMPACT POWER PACK

Good-Bye  
to  
Battery Expense!  
for



- Portable Receivers
- Transmitters
- Walkie Talkies
- Remote Controls
- Test Equipment

This efficient pack works on any 6 Volt DC source, and has such desirable design features as neon voltage regulator, complete filtering, remote load start relay, etc. Brand new in sealed Navy inspected cartons, fully guaranteed. One of the most sensational HSS values ever offered!

Complete Vibrator Pack, less only battery (use it on four flashlight cells or your car battery, etc.) ..... **\$3.95**

For little more than the cost of one set of regular dry batteries, you can obtain a new, modern, vibrator pack that will save you space, weight, and money! Ruggedly made for Navy radio equipment, this pack gives excellent service under the roughest field conditions.

- Only 1 1/2" x 3 1/2" x 4" high (6 1/2" high with battery!)
- Weighs 3 lb. 10 oz., complete with battery.
- Delivers: 135 volts at 20 ma. in continuous Military duty or 30 ma. or more, in intermittent Amateur service; 87 1/2 volts at 8 ma; 1.5 filament or 6.3 heater, bias, and microphone voltages.

Complete Power Pack including clip-in Willard storage battery. Unbreakable plastic Non-Spill Case (open if turned upside-down!) Shipped bone-dry, fully charged, ready to put into immediate service, or to store for years. Can give several hours of continuous operation at full rated load and then be recharged for only a few pennies by any 1/4 ampere charger or our special trickle charger ..... **\$5.50**

Spare Storage Battery ..... **\$2.75**

BATTERY CHARGER, Noiseless, Selenium rectifier type, to trickle charge three or any other small batteries at .2 Ampere, 110 Volt AC ..... **\$3.45**

If recharging facilities are unavailable we can supply these packs with clip-in Willard 6 volt lead-zinc Primary batteries, 25 watt hour capacity. Unlimited shelf life! (Can store for years! Excellent for export.) 1 1/2" x 3 1/2" x 2 1/2", only 21 ounces! Complete pack with TWO Primary ..... **\$5.75**

REPLACEMENT PRIMARY BATTERIES. These batteries are also a fine source of 6 Volts DC for many other applications. 95c Each ..... **95c**

Export packed case of twenty ..... **\$14.75**

## ART-13 COLLINS AUTOTUNE TRANSMITTERS

Here's the most desirable transmitter for Amateur and Commercial service available in surplus today—the famous airborne ART-13!

Frequency meter type VFO—Adjustable fully automatic tuning with remote control provision—tial controlled calibrator—813 final, modulated by 811's—2 to 18.1 Mc. (Adaptable to efficiently cover 10 meter band)—antenna tuning network and automatic relay—easily converted into a FB Ham Phone—CW transmitter with modern commercial features. See the complete articles in November CQ and December Radio News.

Brand new, in sealed containers. The latest improved production 47A. Less tubes and power supply ..... **\$12450**

(With complete set of tubes, \$144.50)

## BC-406 15 TUBE UHF RECEIVER \$19.95

(BC-406-A 16 Tubes, with motor—\$29.75) These are the good ones! Complete with tubes and conversion instructions. Ask the ham who got one from us! See our previous ads.

## TELESCOPING ANTENNA

Signal Corps AN29-C. Sturdy, lightweight, brass antenna extends to 12' 10", telescopes to 15 inches. 1/2" diameter. Weighs only 30 oz. FB for mobile, or rotary beam elements. Six at **\$1.74** each ..... **\$1.95** each

## OIL FILLED CONDENSERS

Standard makes, new, guaranteed, all at prices that will save you money! HSS 2 Mfd, 1000 Volt. Round, upright case mounts in 3/4" hole. FOUR for **\$2.34**

Rectangular, upright cases, with ceramic terminal insulators:

4 MFD. 600 VOLT	THREE for \$1.98
10 " " "	TWO for 2.47
8 " " 1000 " "	TWO for 3.88
4 " " 1500 " "	TWO for 3.98
3 " " 4000 " "	4.95
1 " " 6000 " "	2.45

## 3E29 (829B) TUBES

New, perfect, Gov't accepted ..... **\$4.79**

24G TUBES (3C24/VT204) An FB triode for VHF, 90 Watt rated Class C output, 6.3 Volt, 3 amp filament. Small bulb. Made by H & K, Gov't inspected, fully guaranteed! Regular amateur net price was \$9.00, reduced to **\$1.49**. \$6.00. Harrison sells them for only ..... **\$1.49**

The last time we offered these popular tubes, orders and reorders came in so heavy, we had to ration them. But this time, we think we have plenty—so order as many as you want—spares—presents, etc.!

## KW MODULATION TRANSFORMER

Here's an FB HSS value in a hard-to-get item! RCA commercial quality construction. Conservatively rated at 550 Watts of audio, will modulate up to a kilowatt final.

Primary matches any Class B modulators up to 10,000 ohm plate to plate. Impedance ratio 1:1. Secondary carries 450 ma. Tertiary winding to modulate screens or suppressors carries 80 ma.

Mycalex terminal board with three adjustable protective flash-over caps insures against breakdowns. Open frame mounting. Actual weight 38 1/4 lbs. **\$24.75**

9 1/2" x 7 1/2" x 7 1/2" high ..... **\$24.75**

## ANTENNA TUNING UNIT

Signal Corps BC-939-A (Hallcraft AT-8) Will efficiently couple up to 1KV transmitter to any short or long wire antenna working against ground. Full range of 1.5 to 18 Mc.

You've seen these sold as surplus at \$79.50. Harrison sells them NOW, brand new, complete with RF meter, cabinet, and both plug-in vacuum condensers, for only ..... **\$29.95**

## COAXIAL CABLE

Save money! See our previous ads for all types! RG 58/U. 55 ohms. An efficient, light-weight transmission line (.195" OD) for Amateur, FM, and Television antennas. Also use as high quality, inexpensive crystal mike or pick-up cable. List price, \$18.50

HSS SPECIAL—100 feet for ..... **\$3.95**

## TRANSMITTERS

Still the best buy in a modern, post-war rig! Conservative output rating of 75 Watts Phone, 100 Watts CW. The price of \$495 brings you a FB stable VFO, full coverage of 10, 15, 20, 40, and 80 bands, one dial tuning, band-switching, and everything to go on the air but key, microphone, and antenna. Add it up Yourself and you'll see why the Temco 75-GA is gaining such popularity!

And to step up your power later, just slip it into the 500 GA Amplifier and you will have a complete, well engineered 750 Watt output transmitter.

Order your 75-GA from Harrison, to-day!

## ★ ALL STANDARD LINES

We are Factory Authorized Distributors for the top quality manufacturers and we now have in stock lots more new, latest improved production Ham gear! Visit our stores today, for everything you need. We promise you fresh clean material—quicker—at the lowest current prices—and above all, our sincere desire to be of friendly, helpful service.

MAIL ORDERS? Certainly! Just list everything you want (items in this ad, or any ad, magazine, or catalog) and include remittance.

Vy 73 de

Bil Harrison, W2AVA

HAM HEADQUARTERS  
Since 1925!



HARRISON RADIO CORPORATION

9 WEST BROADWAY • NEW YORK CITY 7

PHONE—BArclay 7-9854 • EXPORT DEPT.—CABE—HARRISONRAD

JAMAICA BRANCH—172-31 Hillside Ave.—REpublic 9-4102



**SOMETHING NEW IN  
TEST EQUIPMENT!**

**THE FEILER TS-3  
SIGNAL TRACING  
"STETHOSCOPE"**



**Save Time... Earn More  
on Every Radio Repair Job!**

GETS TO THE HEART OF RADIO TROUBLE IN A FLASH! There's nothing like the FEILER STETHOSCOPE for saving service time—solves the toughest repair problem in minutes. To isolate and locate trouble, you just "listen in" on or "look at" the signal as it progresses through the circuit. Traces trouble at First Grid, R.F., I.F., Audio; tests parts; locates causes of mistracking, intermittence, distortion, etc. Features: 1" dia. aluminum probe with 3 ft. cable; full 5" PM Speaker; R.F. vacuum tube voltmeter circuit provision for visual indication of R.F. voltages; Output meter provision; Headphone connection. In handsome brown-finished steel case with carrying handle; 8"x11½"x 6"; wt. 10½ lbs. Operates on 105-125 volts, 50-60 cycles A.C. A professional instrument for the Service Engineer who wants the best at a moderate price. Complete with valuable Radio Service Guide.

MODEL TS-3 Signal Tracing STETHOSCOPE for A.C. operation. Complete with 2-1T4 (or 1L4); 1-6K6 (or 6F6), and 1-6X5 tubes.

ONLY  
**\$34<sup>95</sup>**

IMMEDIATE DELIVERY! Place your order with your regular parts jobber. If he can't supply you, write for name of nearest local jobber stocking the FEILER STETHOSCOPE—or send your order to us direct.



FEILER ENGINEERING CO., Dept. 2-A-7  
803 Milwaukee Ave., Chicago 22, Illinois

Ship me one TS-3 STETHOSCOPE.

\$..... enclosed.

Send me FREE descriptive literature.

Send name of local jobber stocking TS-3.

Name .....

Address .....

City .....

Zone .....

State .....

**NEW**

**RADIO-ELECTRONIC DEVICES**

**ADVANCED VOLTOHMYST**

Radio Corp. of America  
Camden, N. J.

The new type WV-75A meter employs a newly-developed diode probe for measuring very high frequency voltages in addition to the refinements of the Voltohmyst Type 195A. It is useful for FM, television and other high frequency measurements.

The probe contains a full-wave rectifier which makes it possible to read both positive and negative voltage peaks at high frequencies. Coaxial cable is used between the probe and meter.

When used for FM and television testing, the meter can make all measurements in radio receivers up to 1,000 volts, from the primary of the power transformers to the output transformer or voice coil of the speaker. It is also

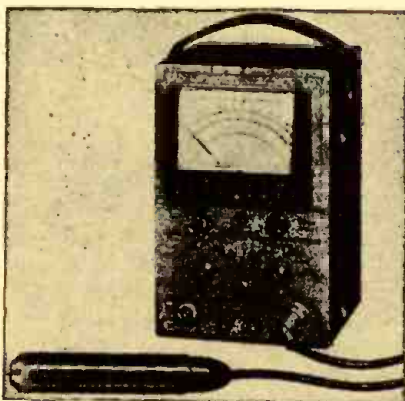

used for checking d.c. measurements directly at the grid, plate, screen, or cathode terminal, as well as bias-cell voltages and a.f.c., a.v.c., and FM discriminator voltages.

When used as an ohmmeter, the one scale works for all ranges with no zero resetting necessary. It has six scales for d.c. resistance readings, covering the ranges 0 to 1,000 ohms to 0 to 1,000 megohms. The internal voltage source used for resistance measurements is three volts.

The meter case weighs nine pounds and measures 9½ inches high, 6¾ inches wide, and 6¾ inches deep.—RADIO-CRAFT

**ELECTRONIC SWITCH**

General Electric Co.  
Schenectady, N. Y.

The new Type YE-9 electronic switch will show simultaneously for comparison, two or more independent signals on the screen of a single cathode-ray tube oscilloscope. Mechanical vibrations, sound, light, and other quantities transferable into electrical functions may be compared. By using two Type YE-9 electronic switches in cascade, three independent circuits can be studied simultaneously. It may also be used with any oscilloscope with a horizontal sweep



voltage and available connections to the plate of the cathode-ray tube.

Operating on any sweep frequency of from 10 to 12,000 c.p.s., continuously variable, the switch has an amplifier frequency response of 4 c.p.s. to 450 kc (flat within 3 db). Its input voltage is 110-125, 50-60 cycles, and its maximum signal input is 250-volt r.m.s.—RADIO-CRAFT

**SOUND PRESSURE METER**

Massa Laboratories, Inc.  
Cleveland, Ohio

The Model GA-1002 sound pressure measurement system is a precision electro-acoustic instrument for making absolute sound pressure measurements over the entire audible and early supersonic frequency range to about 40 kc.

The complete system includes a

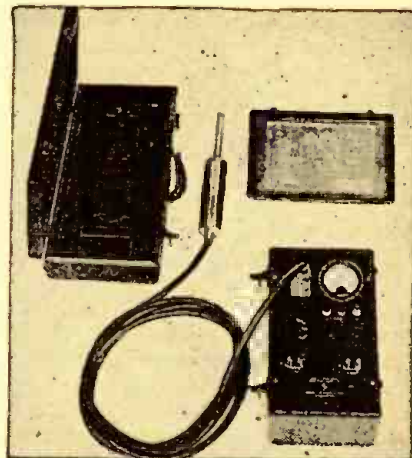

Model M-101 standard microphone, a shock-mounted preamplifier with 15 feet of cable, and an auxiliary amplifier complete with dry batteries. A built-in calibrating circuit permits setting the gain to produce an output of exactly 1 millivolt per dyne/cm<sup>2</sup> sound pressure, so that a conventional electronic voltmeter can be employed for the direct reading of sound pressure. A wide dynamic range permits measurements from less than 1 dyne/cm<sup>2</sup> to 20,000 dynes/cm<sup>2</sup> (160 db level) without distortion.—RADIO-CRAFT



**TUBE TESTERS**

Sylvania Electric Prods., Inc.  
New York 18, N. Y.

The new instruments, a counter type 139 and a portable type 140, provide accurate tube testing facility for shop, spot testing in the home, industrial electronic applications, automobile and mobile radio equipments. Accurate checks of receiving type tubes used in broadcast receivers, FM, television, industrial electronic controls, record players and photoelectric devices may be made un-



der dynamic conditions and without damage to tubes.

Extra sockets and switch contacts are included for modernization as new types of tubes are developed. Test for shorts may be made without danger of grid-filament contacts due to electrostatic attraction in battery type tubes where spacing between these elements is close. Provision is also made for noise testing.

Both instruments are supplied for 105-125 volts, 50-60 cycle a.c. operation and are rated at 20 watts. Controls are readily accessible and all markings, including those on the 4 1/2-inch meter face are easily read.—RADIO-CRAFT

**GRID AND PLATE CAPS**

Eitel-McCullough, Inc.  
San Bruno, Calif.

Eimac HR heat dissipating connectors are used to make electrical connections to the plate and grid terminals of Eimac and other vacuum tubes, and,

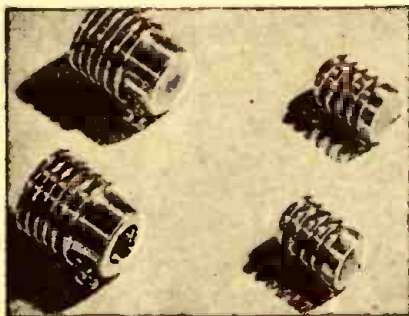

at the same time, provide efficient heat transfer from the tube element and glass seal to the air. They aid materially in keeping seal temperatures at safe values. The connectors are machined from solid dural rod, and are supplied with the necessary machine screws.—RADIO-CRAFT

RADIO-CRAFT for JANUARY, 1947

# Prepare NOW for a Better Job in RADIO ENGINEERING



**Don't Delay - Write Today!**

## ADD TECHNICAL TRAINING TO YOUR PRACTICAL EXPERIENCE.

CLEVELAND INSTITUTE COURSES OFFER COMPLETE TECHNICAL TRAINING RANGING FROM LOW-LEVEL TO COLLEGE-LEVEL.

- A. Master Course in Radio Communication. Covers fundamentals of Radio and includes complete preparation for FCC Commercial License Examinations.
- B. Advanced Course in Radio Communication Engineering. A college-level Radio Engineering course.
- C. Specialized Television Engineering. Including post-war Television Techniques.

**All Courses Include**

The Remarkable Workbooks of Instructional Aids, prepared by the instructing staff of Cleveland Institute.

Choose the course best suited to your needs—Start with the section you are qualified to enter—Use the economical CIRE "Pay-As-You-Go Plan."

You may enroll for individual sections for highly specialized training. Study any one or more of the following sections if you do not require a complete course—

- 1. Mathematics of Radio
- 2. Fundamentals of DC and AC Theory.
- 3. Essentials of Radio Communication.
- 4. Communication Networks.
- 5. Advanced Radio Telephony for the Broadcast Operator.
- 6. Audio and Radio Components and Systems (Design of Receiver and Transmitter Equipment).

Write for descriptive folder • No obligation

## CLEVELAND INSTITUTE OF RADIO ELECTRONICS

CONTRACTORS TO THE CANADIAN BROADCASTING CORPORATION  
Successors to

NILSON RADIO SCHOOL  
Founded 1939

SMITH PRACTICAL RADIO INSTITUTE  
Founded 1934

RC-1 TERMINAL TOWER, CLEVELAND 13, OHIO

Approved for Veteran Training Under "G-I Bill of Rights"

**(MAIL THIS COUPON)**

Cleveland Institute of Radio Electronics, RC-1, Terminal Tower, Cleveland 13, Ohio.  
Gentlemen: Please send information about your home study courses in Radio Electronics.

NAME .....

ADDRESS .....

CITY .....

ZONE ..... STATE .....

I desire training in .....

I have had experience in broadcasting  servicing

operating  mfg.  CAA  Army-Navy

amateur  other ..... I am a

High School Grad.  College  Degree .....

Check here for Veteran Enrollment Information.

## RADIO BOOKS BY MAIL

OVER 125 TITLES IN STOCK

SAME-DAY SHIPMENT ON 98% OF ALL MAIL ORDERS. Books of nearly all radio publishers. If you don't know price, send deposit and we'll ship C.O.D.  
SEND STAMP FOR CATALOG TO EDITORS AND ENGINEERS, Ltd. 1305 Kenwood Road • Santa Barbara, California

## IN THE MIDDLE-WEST IT'S Radio Specialties Company

RADIO AND ELECTRONIC EQUIPMENT  
DETROIT 4, MICHIGAN, 456 CHARLOTTE  
PHONE: TEMPLE 2-0800  
TRY US • WE PROBABLY HAVE WHAT YOU WANT • IF NOT WE'LL GET IT.

## STROBO-LIGHT

Kluge Electronics Co.  
Los Angeles, Calif.

The new a.c.-operated portable Strobo-Light uses a K-60 bulb which has a light intensity rating approximately 100 times that of sunlight. This bulb will take approximately 10,000 pictures.—RADIO-CRAFT

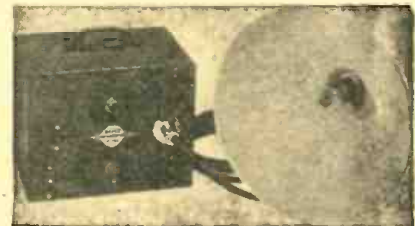



# TRY THIS ONE



**ALLIED**  
*Sound for '47!*  
**New 30 WATT De Luxe**  
**PORTABLE P. A. SYSTEM**

Here's a preview of ALLIED Sound for 1947 in this smoothly-styled, brilliantly engineered 30 Watt De Luxe Portable System. New stabilized inverse feedback circuit delivers high output, usable right up to its peak. Flexible operation is provided by two microphone and one phono channels, each with separate control. Has bass-treble tone control. Amplifier and speakers are safety-fused. Amplifier gain on microphone is 128 db; on phono, 80 db. Frequency response: 50-10,000 CPS. System covers up to 4,000 persons, or up to 20,000 square feet.

Complete 30 Watt System includes: 30-Watt De Luxe Amplifier with tubes; 2-12" Safused Dynamic Speakers, with 30-ft. cables and plugs; 1-Cardax Unidirectional Microphone with floor stand and 20-ft. cord and plug. Complete in handsome luggage-type split portable carrying case, 22"x20"x15". Carrying wt., 60 lbs. For 110 volts, 60 cycles A.C. (Less phono top and volume level meter which are optional.)

Complete System (approximate price) Only ..... **\$99.50**

**ALLIED**  
 For Everything  
 in Radio and  
 Sound

See your ALLIED Catalog No. 111 for the world's largest and most complete stocks of quality radio and sound equipment—at today's lowest prices! Count on ALLIED for fast service, expert help. If you haven't a copy of Catalog No. 111—send for it now—it's FREE for the asking.

## ALLIED RADIO

ALLIED RADIO CORP.

833 W. Jackson Blvd., Dept., 2-A-7, Chicago 7, Ill.

Ship 30-Watt Portable System described above. \$..... enclosed.

Send full details on ALLIED Sound.

Send FREE Radio Catalog No. 111.

Name.....

Address.....

City.....Zone.....State.....

### SUBSTITUTION GADGET

I find Mr. Cox's Serviceman's compass, page 780 of the August issue, too cumbersome for use on midget receivers: A quicker and easier way is

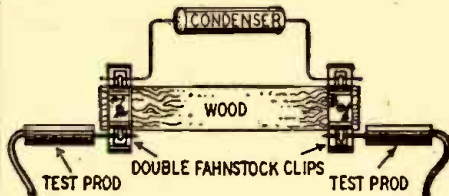

to solder a Fahnestock clip on each end of a piece of twisted light cord. Cut one of the wires shorter than the other so that the clips cannot touch. Tin the opposite ends to serve as test prods. Resistors, condensers, coils, etc. are fastened to the clips.

If you have test prods, double clips may be fastened to a 1 x 2-inch piece of bakelite, plastic or Masonite. The upper clips are used to connect to the spare parts, the lower ones connect to the test prods.

HELEN M. DOUGLAS, W5LGY,  
 Commerce, Texas

### CHASSIS SUPPORTS

When experimenting with or servicing small radio sets, unshielded coils and tubes are often damaged when the chassis is inverted on the work bench. To prevent this trouble, mount a "C"

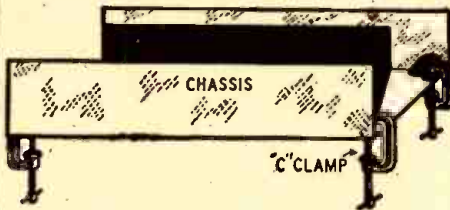

clamp on each corner of the chassis. When the chassis is inverted, it rests on the screws of the clamps.

RICHARD C. SZUMILO,  
 West Hazelton, Penna.

### TEST LEAD SAVER

I have often been irritated to find that my test leads have been broken at the point where they enter the prods or plug.

To prevent this from recurring, I se- )



lected four dial springs. The outside diameter should fit snugly into the open ends of the prods and plugs. Place two springs on each wire. The springs are forced down into the open end of the tips and held in place with a few drops of cement. The springs will prevent the test leads from breaking at these points.

WALTER M. BOWLAN,  
 Prince Edward Island

### TUBE REPLACEMENT

On page 558 of the May issue, there is a description of a method of replacing Sparton 183's with 45's. This method calls for series connection of the filaments to operate from the five-volt filament winding. When the filaments are connected in this manner, hum will result from the varying a.c. across the bias resistor.

This may be corrected by using only half of the filament winding and con-

RADIO-CRAFT wants original kinks from its readers, and will award a one year subscription for each one published. To be accepted, ideas must be new and useful. Send your pet short-cut or new idea to RADIO-CRAFT today!

necting a 20- to 50-ohm center-tapped resistor across the paralleled filaments of the 45's. The biasing resistor is con-

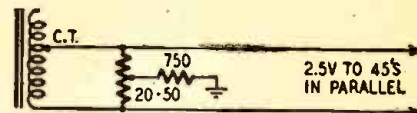

ected between the center-tap and ground. When the filaments are connected in this manner, no hum is present.

ALLIN W. JACKSON,  
 Edmonton, Canada

(Note: 2A5's may be used with the filaments connected in series without causing hum.—Editor)

### NOVEL PANEL LAMP

A very neat panel lamp for illuminating the dials on a receiver or transmitter may be made from the cap of a

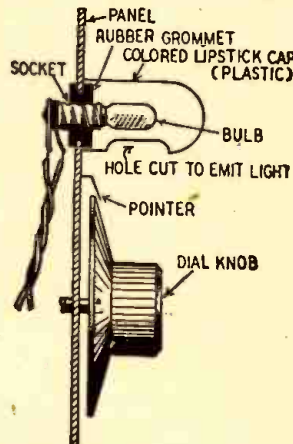

discarded plastic lipstick tube. A hole is drilled in the panel to take a rubber grommet whose outside diameter is large enough to fit snugly into the open end of the lipstick cap. A hole or slot is cut in the cap so that it will cast a ray of light on the dial.

HARRY KUNDRAT,  
 Garwood, N. J.



## TECHNOTES

(Continued from page 105)

### ... TRUETONE D2630

The complaint on the first three of these new sets was poor reception. The trouble has been traced to a shorted primary on the output i.f. transformer. In all cases, the remedy has been to replace the mica in the trimmer condenser.

JACK C. WHITE,  
Starkville, Miss.

### ... HUM CURE

Recently I was called in to service a new receiver that developed a severe hum during the early mornings and late at night. All filters and tubes checked OK. A line voltage check was made and it was found that the voltage often reaches 135 volts. A Clarostat Automatic Regulator was installed.

G. SAMOFKY,  
Brooklyn, N. Y.

RADIO-CRAFT wants *Technotes* describing common troubles of well-known receivers or telling how rare or difficult problems were solved. A six-month subscription will be awarded for each unillustrated and a one-year subscription for each illustrated *Technote* published.

### ... SEALING TRIMMERS

To prevent customers from tightening the "loose screws" on trimmers and padder condensers, melt a bit of rosin with a hot soldering iron and allow it to run down on the head of the adjustment screw. The rosin will cool and hold the screw in place.

H. T. BROWN,  
Jacksonville, Fla.

(Note: Nail polish or Duco cement can be used for the same purpose. It is also useful in sealing the condensers in automobile and portable radios.—*Editor*)

### ... CRYSTAL DIODES

When the still critical diode tubes, 1H5, 75, 12Q7, etc., need replacing, use the new crystal diode, 1N23, as a substitute for the diode section. Connect it in series with the wire removed from the diode plate connection and the cathode. Polarity should be observed. If the triode section is also bad, rewire socket and use straight triode tube.

A. G. SANDERS,  
Miami, Fla.

(While the crystal mentioned might give good service in many cases, it would seem that the 1N34 would be much more suitable for use as a diode detector for strong signals.—*Editor*)

### ... G.E. TESTERS TC3 AND TC3P

When checking for shorts, in tubes having a high plate-to-cathode capacity, these testers will indicate a short in almost every case. This is particularly noticeable with pentode and tetrode output tubes. This condition is normal

# GET YOUR FCC Commercial Radio Operators' LICENSE

Now...

How To Pass  
FCC  
LICENSE  
EXAMINATIONS

CLEVELAND INSTITUTE  
OF  
RADIO ELECTRONICS  
Terminal Tower - Cleveland, Ohio

Don't Delay—  
Write Today!

## It's Easy If You Follow Our Plan

Thousands of new jobs are opening up—**FM, TELEVISION, MOBILE COMMUNICATION SYSTEMS**, are only a few of the new radio fields which require licensed operators.

**FREE BOOKLET** Tells you the Government requirements for all classes of commercial operator licenses. Tells where to apply for and take the examinations, examining offices, scope of knowledge required, extracts from FCC Rules and Regulations, extracts from FCC Study Guide and Reference Material, approved way to prepare for FCC examinations, positive method of checking your knowledge before taking the examinations.

**Edition Limited—Mail Coupon Before Supply Is Exhausted**

## CLEVELAND INSTITUTE OF RADIO ELECTRONICS

CONTRACTORS TO THE CANADIAN BROADCASTING CORPORATION  
Successors to

NILSON RADIO SCHOOL  
Founded 1939

SMITH PRACTICAL RADIO INSTITUTE  
Founded 1934

RC-1 TERMINAL TOWER, CLEVELAND 13, OHIO

Approved for Veteran Training Under "G.I. Bill of Rights"

### MAIL THIS COUPON

### CLEVELAND INSTITUTE OF RADIO ELECTRONICS

RC-1 TERMINAL TOWER, Cleveland 13, Ohio

Gentlemen: Please send your FREE Booklet, "How To Pass FCC License Examinations."  
(Note: This Booklet does not cover examinations for Amateur License)

NAME ..... I have had experience in broadcast-  
ing  servicing  operating   
ADDRESS ..... mfg.  CAA  Army-Navy   
amateur  other .....

CITY ..... STATE ....

Check license desired:

Radiotelephone  1st. Class  2nd Class

Radiotelegraph  1st Class  2nd Class

I am a  High School Grad. College  
Grad.  with degree .....

I now hold these licenses ..... If a War Veteran, check here

with this model tester. (Can any of the readers tell us how a true short can be detected with this model tester? —*Editor*)

JOHN FINDARLE,  
Modesto, Calif.

### ... OSCILLATOR COILS

Most defective oscillator coils may be rewound by hand satisfactorily enough to eliminate re-alignment. Count the turns as they are removed. Note the direction of the winding and location of taps, if any. Replace the windings, duplicating the original coil as closely as possible. Slight variations in wire size and type of wiring have little effect on tuning.

A. G. SANDERS,  
Miami, Fla.

### ... SILVERTONE R-1181

The complaint on this receiver is intermittent crackling and frying. This is often due to the .003- $\mu$ f, 1500-volt, condenser connected between the plates of the 5Y3. This condenser develops internal arcing after a period of service and should be replaced with a new unit.

B. S. NORKUS,  
Stratford, Conn.

### ... ATWATER KENT 55C

When aligning the belt-ganged condensers on this model, be sure to clean the supporting bearing of each rotor with carbon tetrachloride. The brass tension spring on each rotor should also be checked for tightness.

CLAUD M. PREW,  
New London, N. H.



# FREE



It's NEW, it's BIG, it's COMPLETE. It's Lafayette's latest, greatest catalog brimming with EVERYTHING that you want in Radio and Electronics. Radiomen and servicers, hams and dealers, hobbyists and experimenters—this is the book for YOU. Mail Coupon!

## BIG NEW LAFAYETTE RADIO CATALOG

Pages are crammed with standard items as well as all new developments. They're in stock — they're ready for super-speed delivery — they're priced for super-economy. If radio's your hobby, if radio's your business — if you're mild about it or wild about it—this is THE book!

IT'S YOURS FREE

### Lafayette Radio

RADIO WIRE TELEVISION, INC.

100 Sixth Avenue, New York 13, N. Y.  
 210 2nd St., Boston  
 Control No. 1005

RUSH  
 COUPON  
 TODAY

LAFAYETTE RADIO Dept. JA-7  
 100 Sixth Avenue, New York 13, N. Y.  
 RUSH your big new catalog to me by  
 return mail.

NAME \_\_\_\_\_  
 ADDRESS \_\_\_\_\_  
 CITY \_\_\_\_\_ ZONE \_\_\_\_\_ STATE \_\_\_\_\_

PASTE COUPON ON PENNY POST CARD

# RADIO-ELECTRONIC CIRCUITS

## SIMPLE INTERCOM

Here is a diagram showing how an amplifier may be converted to an intercommunicator. The sub-station and master speakers are equipped with 500-ohm line-to-voice-coil transformers. The amplifier is fitted with an output transformer to match a 500-ohm line and a

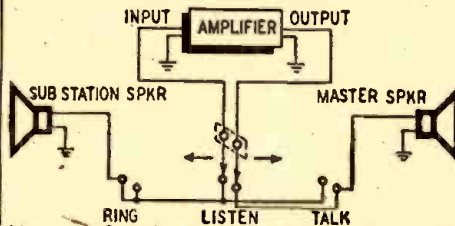

Note — Switch connections are incorrectly drawn; reverse connections to "talk" switch contacts.

line-to-grid transformer is used in the input.

A two-pole three-position switch is used to switch the connections to Talk, Listen and Ring positions. In the "talk" position, the master speaker is connected to the input circuit and the remote speaker is connected to the output of the amplifier. These connections are reversed when the switch is thrown to Listen. When the switch is in Ring position, the remote speaker is connected to the output of the amplifier. Feedback for ringing is supplied by connecting the amplifier output to the input circuit.

All leads leading to the switch should be carefully shielded to prevent unintentional audio feedback. The switch and the terminals for connecting the speakers and amplifier circuits may be constructed in a small metal box placed close to the amplifier.

DON RUSSELL,  
 Toronto, Canada

## V.H.F. OSCILLATOR

With very low power and no antenna, this 112- to 300-mc parallel-line oscillator makes an ideal signal generator for testing v.h.f. receivers.

The oscillator uses parallel-line tuners in the plate-grid and cathode circuits. The plate-grid inductors con-

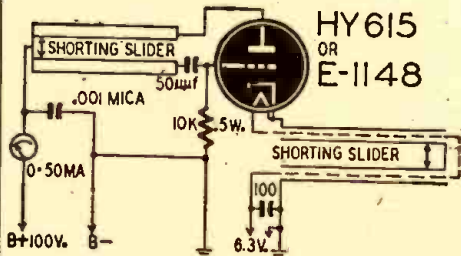

sist of two pieces of 5/16 inch brass tubing, 12 inches long, spaced 1 inch center-to-center. They are mounted above the chassis with standoff insulators which permit the shortest connections to the plate and grid caps of the

tube. The tubes are joined together at the B-plus end with a piece of No. 14 wire.

The cathode inductors are made of the same material, seven inches long, mounted below the chassis. One of the filament leads is threaded through the tubes and the other is connected to ground through the inductor. The open ends are connected with a piece of No. 14 wire.

The oscillator frequency is determined by the position of the shorting bar on the plate-grid inductors. The shorting bar on the cathode inductor is varied for maximum output and best stability at the desired frequency. The normal plate current is from 10 to 12 ma.

The oscillator may be either plate or

RADIO-CRAFT welcomes new and original radio or electronic circuits. Hook-ups which show no advance on or advantages over previously published circuits are not interesting to us. Send in your latest hook-ups—RADIO-CRAFT will extend a one-year subscription for each one accepted. Pencil diagrams—with short descriptions of the circuit—will be acceptable, but must be clearly drawn on a good-sized sheet.

grid modulated if desired. Output may be taken from the oscillator with a hair-pin loop coupled closely to the B-plus end of the plate-grid inductor. The loop may be connected to an antenna or to the tuned grid circuit of an amplifier stage.

P. F. EGERTON, JR.  
 Toronto, Canada

(Note: The oscillator may be shielded to prevent uncalibrated v.h.f. receivers from being tuned to one of its harmonics. The signal generator does not require modulation when it is being used to align and calibrate regenerative and superregenerative receivers.—Editor)

## SIMPLE POWER SUPPLY

This is an interesting a.c. power supply that uses a power transformer from an automobile radio. The unit will supply up to 250 volts of well-filtered d.c. at 75 ma and 6.3 volts for tube filaments.

The center-tapped secondary winding is used as an auto-transformer with the a.c. line connected between one end and the center tap. The rectifier plates are connected across the entire winding in the conventional manner. The OZ4-G was selected for the rectifier because of its small size and the cold cathode which does not require heater voltage. A brute-force filter section provides ample filtering action. A 25,000-ohm semi-variable resistor is connected across the output of the unit so that the voltage can be lowered when necessary.

Filament voltage is taken from the primary winding. The center tap, if any, should be grounded.

This unit is connected directly to the



power line and should not be used with any equipment that uses a direct ground. If a ground is needed, it should

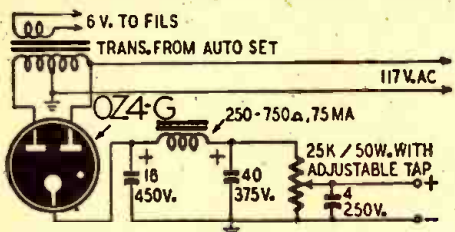

be made through a .01-μf 600-volt condenser.

RICHARD L. ALLMAN,  
San Francisco, Calif.

(Note: One side of the a.c. input cord is connected to the B-minus of the power supply. Precautions should be taken to be sure that the grounded side of the a.c.-line is connected to the chassis and B-minus.—Editor)

### REVISED TONE CONTROL

I constructed an amplifier and included the tone control system described on

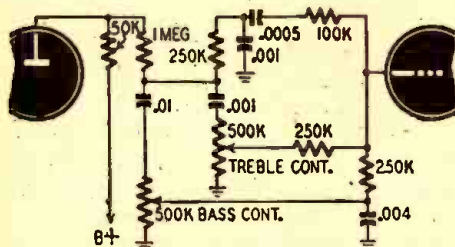

page 97 of the November 1945 issue. The response was as shown in the graph in the original article but I was not pleased with the results. While checking the circuit with a signal tracer, I found that distortion was being generated in the tone control circuit.

The original circuit was revised, as shown in the accompanying diagram, to my complete satisfaction and that of any others who have listened to it.

E. A. CHAPMAN,  
Alberta, Canada

(Note: Tone control circuits of this type are often as critical as tuned-circuit controls. Paper condensers, placed closely together, will frequently have enough inductive coupling between them to produce parasitics. This may be cured by placing the condensers in shields. Cathode bypass condensers will also pick up hum if they are in a strong magnetic field.—Editor)

### PHONO OSCILLATOR

I have used this novel oscillator circuit in a wireless record player which gives excellent results.

The oscillatory circuit consists of a center-tapped inductance connected between the plate and screen grid of a 1S4. The plate voltage is just sufficient to sustain oscillations. Control-grid modulation is used with a volume control connected across the input circuit. If the set tends to overmodulate, insert a 1.5-volt flashlight cell between the con-

trol grid return and the A-minus. The tuning coil consists of 160 turns

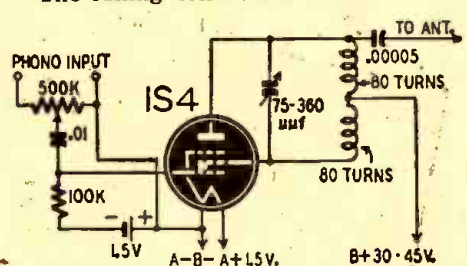

of No. 28 enamel wire jumble wound on a 1/2-inch form.

RUSSELL R. SMITH,  
Grand Rapids, Mich.

### STONE COMPENSATOR

This tone control circuit may be a worthwhile addition to any amplifier using a medium mu triode as an input tube.

This circuit consists of R-C filters which gives good control and response if the values given in the diagram are followed closely.

TED HANNAH,  
Seattle, Wash.

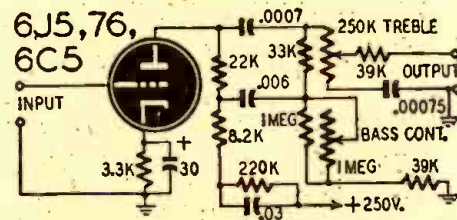

## Olson's 2 Great Money-Savers!

### OHM CHEST

packed with 100 Insulated Resistors

This handsome Chest has twenty compartments — 10 in the base and 10 in a removable tray. Walnut finish; brass hinges and fastener. Contains 100 resistors stamped with resistance values, 5 ohms to 20 megohms, 1/2 watt to 2 watts, color coded. Every size is popular. No war surplus resistors in this Ohm Chest!



\$4.95

Free!

With each Ohm Chest ordered, we send our "Resist-O-Guide" free. Revolving wheels in color show all resistance values.

### CONDENSER KITS

Sweet savings on seventy 600-V. By-Pass Condensers, made to rigid Olson specifications. Will withstand voltages higher than ratings. Worth much more than our low price! Small size (approx. 1 1/2" long, 1/2" dia.) makes these units right for compact circuits. Long tinned copper leads. You get 70 Tubulars, as follows:

QUANTITY	CAPACITY
20	.01
10	.02
20	.05
20	.1

\$4.95

Send for our Free BARGAIN CATALOGS

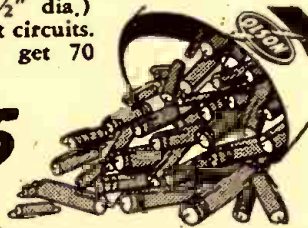

FREE

### Panel Lamp Tool

with each Condenser Kit ordered. Rubber tool grips bulb for easy installation or removal in hard-to-get-at positions.



Paste this Coupon →  
on a penny postcard and  
Mail Today to

**OLSON RADIO WAREHOUSE**  
INC

73 E. MILL ST., DEPT. 63, AKRON, OHIO

Send me \_\_\_\_\_ Ohm Chests with 100 Insulated Resistors in each, @ \$4.95. (Resist-O-Guide free with each Chest.)

Send me \_\_\_\_\_ Kits of 70 Condensers each, @ \$4.95. (I will receive a Panel Lamp Tool FREE with each Kit.)

I enclose \$ \_\_\_\_\_  
Order will be postpaid.

Send my order C. O. D.  
I will pay postage.

NAME \_\_\_\_\_

ADDRESS \_\_\_\_\_

CITY \_\_\_\_\_

STATE \_\_\_\_\_





The Question Box is again undertaking to answer a limited number of questions. Queries will be answered by mail and those of general interest will be printed in the magazine. A fee of 50c will be charged for simple questions requiring no schematics. Write for estimate on such questions as may require diagrams or considerable research.

### EXPANDER-COMPRESSOR

The a.f. section of my radio uses two 6C5's in cascade, transformer-coupled to push-pull 6L6's. Kindly show me how a simple expander-compressor may be added to the circuit.—J.B., New York, N. Y.

Here is a circuit showing how the unit may be added to the a.f. system in your receiver. A 6SK7 control tube is inserted between the two 6C5's. The output of the first 6C5 is also coupled to the grid circuit of the 6SJ7 expander-amplifier. This tube is coupled to a 6H6 rectifier. The output of the 6H6 appears across a 1-megohm center-tapped potentiometer. One side of the resistor is positive with respect to ground and the other is negative. The position of the slider determines the degree of expansion or compression.

### BATTERY INTERCOM

I would like a diagram of a battery-powered intercommunicator using a 1S5 and a 1S4. 4-inch PM speakers are to be used for two-way communication between the master and three remote stations.—J. A., New York, N.Y.

The intercommunicator circuit you requested is shown. Each speaker functions either as a microphone or speaker. The two tubes should give ample gain and volume.

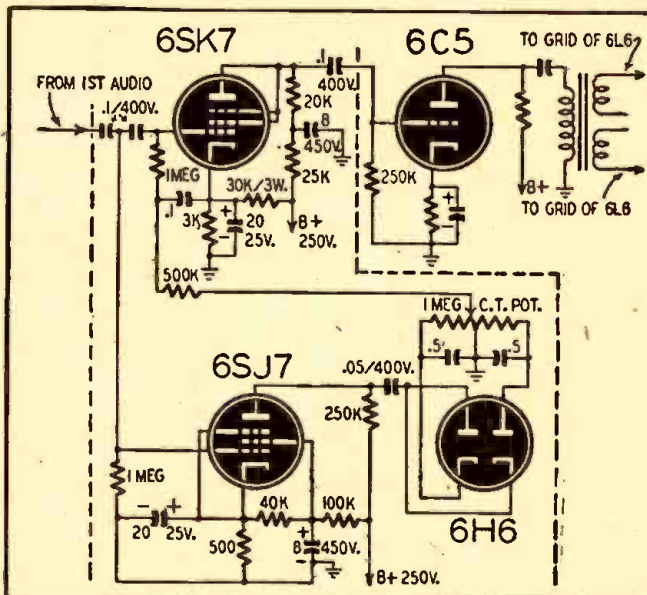

### INTRUDER ALARM

I have been seeking a diagram of a capacity-operated intruder alarm. This unit is to be operated from 117-volt a.c. lines with low current drain while in operation. It is to be used to protect two windows in our home. Is it

should be placed in a small grounded metal box just inside the windows to prevent using long capacity leads which would present a difficult shielding problem and reduce the sensitivity.

The capacity wire or screen may be

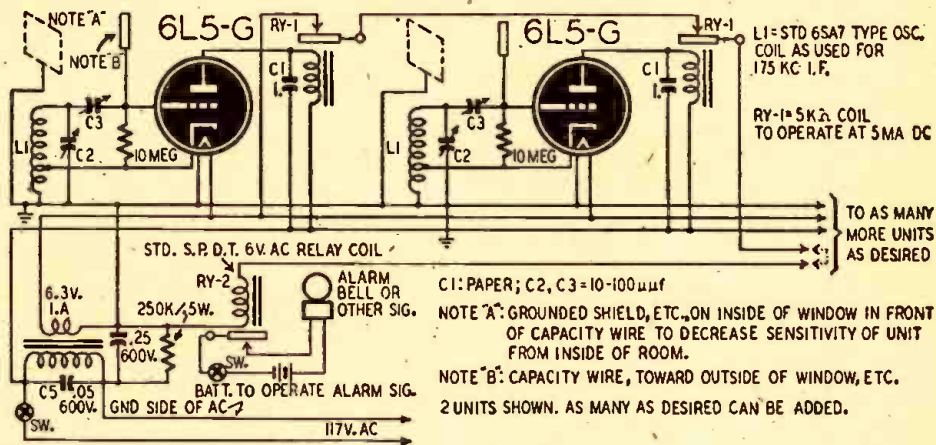

possible to place the wires in such a manner that the alarm will be set off when anyone approaches from outside the house to within a few feet of the windows yet permit the windows to be approached from the inside without triggering the alarm?—J.O.H., San Diego, Calif.

placed toward the outer edge of the window and a grounded shield placed about six inches from the wire on the side toward the room. This will reduce the sensitivity from this side. Each location presents its own problem and it will be necessary to do some experimenting for the best possible results. Each of the protective units uses about two watts of current during the time that it is in operation.

Here is a diagram of a capacity-operated relay. The tube and relay unit

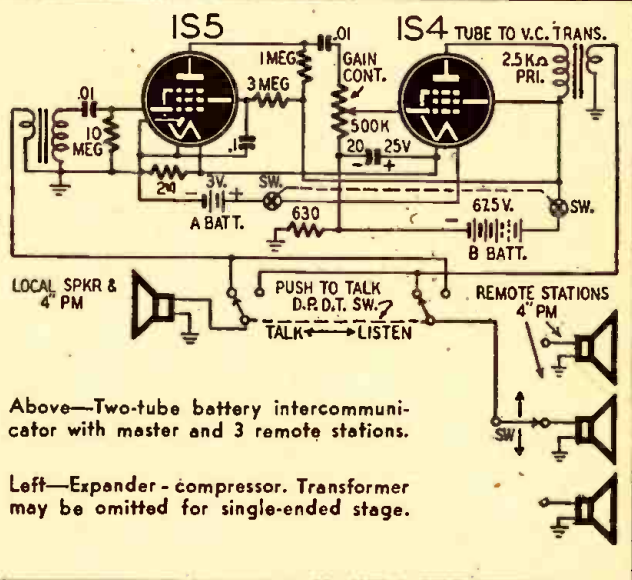

Above—Two-tube battery intercommunicator with master and 3 remote stations.

Left—Expander-compressor. Transformer may be omitted for single-ended stage.





Congratulations to Dr. Lee de Forest on the 40th anniversary of the audion.

**EVERYTHING IN RADIO, ELECTRONIC, AND COMMUNICATIONS SUPPLIES**



**DYNAMOTOR-**  
12 VOLT DYNAMOTOR. 235 Volts output at 90 mls. Complete with filter, mounted in can 6 1/4" x 5 3/4" x 3 3/4" with cover, used but perfect.  
**SPECIAL \$2.95**



**VT-127A/100 TS TUBE**  
This Triode is capable of full output up to 600 MC; a pair will take a kilowatt input with exceptionally high efficiency. Plate Voltage—2500 V; Plate Current 200 ma; Grid Voltage 150 V; Grid Current 25 ma; Filament Current 10 a; Filament Voltage 6V; Amp Factor—15.  
**Special \$3.25**  
Special MYKROY SOCKET for above tube... \$1.25  
HEAT RADIATING CAPS for VT 127... 2 for \$2.25



**FULL WAVE SELENIUM RECTIFIER**  
Perfect for bias application—Use your DC relays from an AC source. Only requires controlled super heat.  
3" x 1/2" mounting space put up to 300V @ 40 ma output.  
**\$.89 or 5 for \$4.00**

**PLATE TRANSFORMER**  
6200 Volt CT—700 Mils. 110 Volts. 60 Cycles tapped Primary 2 KVA AMERTRAN.  
Freight Prepaid Any Part of Continental U. S.  
**\$39.95**



**JAN 829B/3E29 TUBE**  
AND SHIELDED ALUMINUM SOCKET. Has built-in by-pass condensers. Both for the price of the tube socket.  
**Our Price \$6.95**

**CW3 RECEIVER**  
CW3 RECEIVER (used for aircraft monitoring) a fixed freq. receiver (1100 KC to 16,500) xtal controlled super heat with BFO and AC power supply. 110V. 60 cy; Coils can be furnished in any of the following groups: 1100-2100 KC; 3500-6100 KC; 5600-10,000 KC; 9400-16,500 KC; complete with add. set of tubes and one set of coils **less xtal \$32.50**



**MODULATION TRANSFORMER**  
Perfect for Input up to 300 Watts—Class C loads on secondary No. 1, 14000 Ohms—Secondary No. 2 is designed for screen of Tetrode or Pentode—primary will match 811, 809, TZ20 or TZ40 Tubes. Complete factory specifications and circuit diagram included.  
**\$4.95**

**W.E. DRIVER TRANSFORMER CLASS B**  
—matches 6L6 in Push Pull to any Class B grids. Perfect match for a above transformer.  
**\$3.95**

**ANTENNA CHANGEOVER RELAY** for all bands—Isolantite T.P.D.T. Plenty of contact surface. **\$2.75**

**ANTENNA CHANGEOVER RELAY.** Leach Type 1357. DG—13F—DPDT—plenty of spacing—mounted on low loss bakelite **\$2.50**

1000 KC XTAL precision AT Cut mounted in standard holder. **\$4.95**

10 ASSORTED TRANSMITTING MICA CONDENSERS. All well-known brands designed for high Voltage. Assortment your price **\$1.98**

20% Deposit with order. Balance C.O.D.

G.E. PYRANOL 2mfd 4000 Volt filter 23F47 **\$5.50**  
G.E. PYRANOL 4mfd 2000 Volt filter 22F58 **4.25**  
CO DYKANOL 2mfd 2000 Volt **2.49**  
AEROVOX FILTER CONDS. 6mfd 1500 Volts **2.25**

WESTON—No. 476—0-130 Volt AC 3 1/2" Motor; special. **\$4.95**

All Prices F.O.B. our Warehouse N.Y.C.

W2BNW is in charge of our ham Department

Write for our latest Bulletin 12-RC.

**NIAGARA RADIO SUPPLY**

160 Greenwich St., New York 6, N. Y.

back of each key in such a position that they will all make contact with a small rectangle of sheet copper on the key. Obviously they should be adjusted so that the copper touches them slightly before the front contact presses on the graphite-treated cloth covering the front bus. See Fig. 4 for a section of the coupling system.

To better understand the operation of the coupler system, let us take a single note and trace it backward from the key. If, for example, middle C is depressed and only the coupling switch for the fundamental is on, with the others off, the second spring-wire mounted above the back of that key connects the C25 keying circuit—and consequently the amplifier and loudspeaker—with the neon oscillator generating 261.6 cycles or note C25. As a result of depressing the key, therefore, a single note, C25, is heard in the speaker. If now, in addition to the fundamental, another coupler, say the second harmonic, is turned to the on position, neon oscillator C37 (an octave higher), generating 523.3 cycles, will be connected through the second harmonic coupler and subsequently through the third spring-wire contact on key C25 to the same keying circuit. As a result, both middle C and the C above middle C will be heard, even though only the key for middle C be depressed. The same applies in the case of the two remaining coupling

**SIMPLE ELECTRONIC ORGAN**

(Continued from page 71)

switches (sub-fundamental and the third harmonic) where the added notes would be C13 and G44, respectively. With this arrangement one can set the instrument so that it will produce any one of the four harmonics separately, or any of them in combination. For convenience the controls which turn the

couplers are constructed to work like standard organ tablet stops. It might be helpful to those who are accustomed to organ nomenclature to give the fundamental, sub-fundamental, second and third harmonics names of stops which they most resemble: Diapason 8', Bourdon 16', Flute 4', and Nazard 2 2/3'.

Other tonal effects may be obtained by shunting the output transformer with different sizes of capacitors, to filter out more or less of the original

(Continued on page 116)

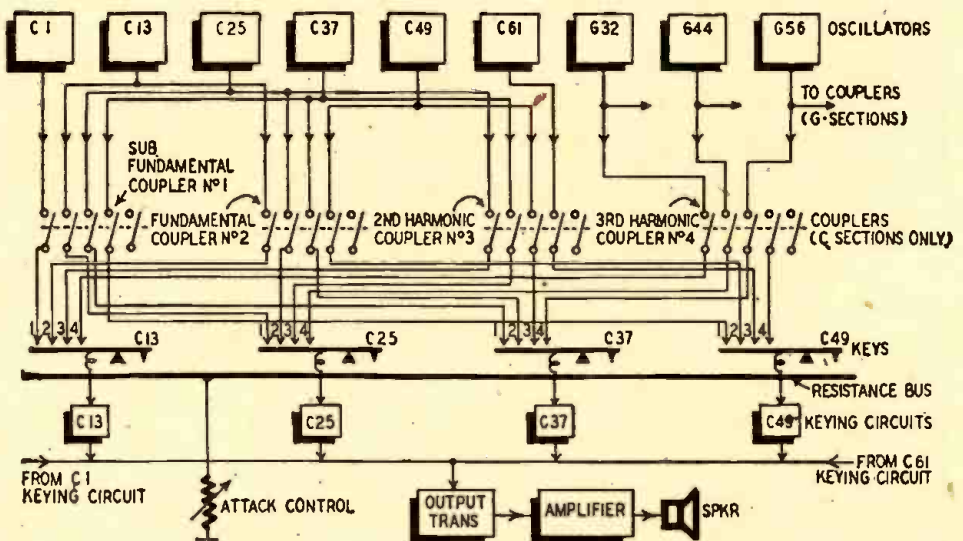

Fig. 4—Section of the four couplers, showing four of the 61 poles (C sections) on each.



**COLOR TELEVISION** with present black-and-white receivers was declared possible as a result of a new electronic color television system, RCA engineers announced at a demonstration October 30 last.

A new color slide television camera produces signals from 35 mm Kodachrome slides. The picture on the slide is transmitted in natural colors when a light beam from a kinescope is focused through the slide and separated into

COLOR FILM SCANNING UNIT

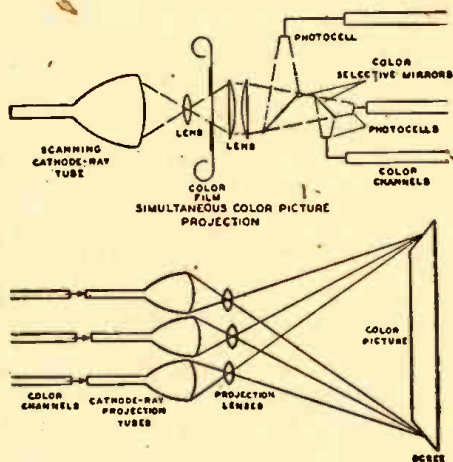

component colors by a system of mirrors and photo-electric cells.

Each of the three transmitted images—red, blue and green—is of the same number of lines, that is, 525; also of the same horizontal scanning rate and the same picture repetition rate of 30 per second as in present commercial television broadcasting.

The receiving set is equipped with



Full-color television receiver with its three cathode-ray tubes.

# RADIO-ELECTRONICS

## Items Interesting

three 3-inch kinescopes, which separately receive the signals representing red, blue and green. This trio of kinescopes is called a *Trinoscope*. From it the three color images are optically projected into a brilliant composite picture which appears on a 15 x 20-inch screen in natural color, free from any flicker, color fringes or break-up. By this new advance in television, simultaneous color transmission, instead of sequential transmission, color by color, is achieved.

Since the electrical characteristics and all of the standards of the green image—including the synchronizing pulses—are identical to those of the present black-and-white standards, any broadcasts from color stations using the electronic simultaneous system can be received clearly on black-and-white receivers by the addition of the easily installed radio-frequency converter. No modifications whatever are required inside the set.

This converter will enable present-day television sets to receive color programs and reproduce them in black-and-white, even when transmitted on ultra-high frequencies. Thus, existing receivers will not be made obsolete by the introduction of color at some future date. On the contrary, their usefulness will be extended.

For example, if a football game is broadcast by a color transmitter, the owner of a black-and-white receiver can see it in black-and-white. Even the oldest television sets can be adapted to tune in the color pictures in black-and-white.

Electronic color television sets will be able to receive the broadcasts of black-and-white stations. Furthermore, when electronic color television is established as a broadcasting service, the black-and-white receivers will be able to reproduce the color broadcasts in monochrome. Engineers explained that this cannot be done with any known system of mechanical color.

**MOST RECENT PATENT** of Dr. Lee de Forest was granted on November 12, 1946. The patent, No. 2,410,868, describes a means and method for determining the altitude of an aircraft above the terrain below.

An extremely brief signal is radiated from the plane, at the same time rendering conductive a tube whose plate current commences to charge a condenser. The reflected signal from the terrain below stops the charging process. A means of measuring the charge which has accumulated in the interval is provided, the measure of charge being read directly in distance units.

A special strongly-damped spark circuit is used for sending out the pulses, which are so short that the instrument may be used to measure distances as small as ten meters.

**DR. W. R. G. BAKER**, vice-president of General Electric in charge of electronics, is the new president of the Institute of Radio Engineers. Dr. Baker is particularly well-known in the fields of FM and television. He is Director of the Engineering Department of the Radio Manufacturers Association; member of the Board of Governors of the National Electrical Manufacturers; chairman of the Electronics Committee of the American Institute of Electrical Engineers, and has held such other prominent positions as chairman of the National Television Systems Committee of the television industry, and first chairman of the electronics industry's Radio Technical Planning Board. He succeeds Dr. Frederick B. Llewellyn, of Bell Telephone Laboratories.

Dr. Baker, elected in November, will take office before the I.R.E. convention and Engineering Show, which will be held respectively in the Hotel Commodore and Grand Central Palace, New York City, March 3 to 6.

**UNIVERSAL DX RECORD** appears to have been set by Grote Reber of Wheaton, Illinois, who described his reception to a recent meeting of the Chicago Section of the Institute of Radio Engineers. The dx described is radiation from the Andromeda Nebula, some 800,000 light-years away, or  $5 \times 10^{11}$  miles!

A highly directional antenna is used to scan the sky, the output feeding into a tuned-radio-frequency receiver. The noise thus received can best be described by calling it a hiss. Many measurements have been made at 160 mc, and measurements are now under way at 480 mc. Various theories have been advanced as to the cause of this static, but none has satisfactorily explained all the observed phenomena.



# MONTHLY REVIEW

## to the Technician

**CATHODE-RAY TUBES** are to be used in broadcast and shortwave radio receivers, General Electric has just announced. The tube is a tuning indicator of new design, and will be especially useful in FM receivers. It will also be useful to radio amateurs and servicemen as its construction and method of presentation makes it particularly adaptable for service as a null-indicator in bridge circuits and test equipment.

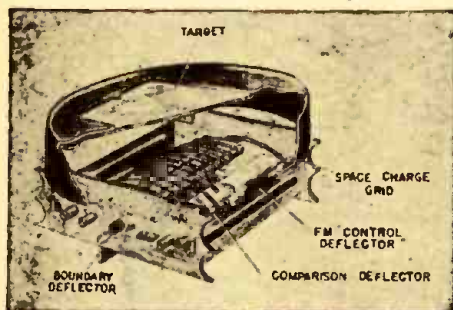

Features of G-E cathode-ray tuning indicator.

In the new electron-ray tube patterns appear on a fluorescent screen located near the end of the glass bulb. This screen differs considerably from that in indicator type electron-ray tubes used in AM receivers in the past. The 6AL7-GT employs a translucent screen, or target, consisting of a transparent disc on which the fluorescent material is deposited. The fluorescent pattern can be viewed through the screen.

The translucent-type screen enables all other tube electrodes such as heater, cathode, deflecting plates, etc., to be behind the target and out of sight. In previous indicator-type electron-ray tubes it has been necessary to locate cathode and deflecting plates in front of the screen, making it necessary to mask out the center of the target.

The tube's three deflection electrodes are adjacent to the cathode and the cathode-deflection-electrode-assembly is separated from the target by the space-charge grid. These electrodes can effectively control the position of the electron beam on the target because the velocity of the electron is low between the cathode and space-charge grid.

By controlling the bias of the space-charge grid the target current and pattern brightness can be affected. Six volts negative grid bias is sufficient to black the pattern out completely if the target voltage is less than 315 volts d.c. "On tune" is indicated when two halves of a pattern which appear on the screen at the end of the tubes are aligned. Deviation from the proper tuning condition on one side of resonance will raise one edge of the pattern and deviation on the other side of the resonance will lower the pattern edge.

**SHORTWAVE RADIO RECORDS** were shattered November 24 last, when a six-meter signal was sent from West Hartford, Connecticut, across the ocean to England. Never before have such short waves been used in two-way trans-oceanic communication.

Climaxing several months of advance preparation and tests, at 11.16 a.m. E.S.T. November 24th the 50-megacycle transmission of Station W1HDQ, owned and operated by Edward P. Tilton, was intercepted by English amateur station G5BY, Hilton O'Heffernan of South Devon, and a few moments later confirmed by G6DH, D. W. Heightman of Essex.

The three men participating, leaders of a group in each country, have been closely watching the performance of these undeveloped channels. Checking their data with predictions of the National Bureau of Standards in Washington, with which amateurs are co-operating in propagation tests, they found some months ago that the late Fall of 1946 promised the most favorable conditions of any recent year, and so arranged a comprehensive series of test schedules. On the morning of the twenty-fourth the English stations reported hearing American frequency-modulation broadcast stations in the 40,000-kilocycle range stronger than ever before and the three amateurs predicted—correctly—that a signal as high as 50,000 kilocycles could be transmitted across the ocean.

**THREE HUNDRED MILLION VOLTS** is the expected output of a new synchrotron under construction at the University of Michigan, joint reports from the Navy and the University reveal. The new nucleus smasher is expected to produce energy approaching that of cosmic rays.

The Michigan synchrotron, expected to be completed early in 1947, differs from others as its electron path is the shape of a race track, not circular. Its designers, Professors H. R. Crane and David M. Dennison, believe the "race track" will have definite advantages when machines with capacities of one billion electron volts are constructed.

Portions of the race track, which will be about 28 feet around, can be seen between the four sections of the magnet which will set up magnetic fields to guide the electrons in their path. The tall, cylindrical part of the synchrotron at the left is the electron gun which will give the electrons an initial "kick" of 500,000 volts to start them on their trip around the race track. The squirrel cage looking device at the right is a resonant cavity similar to that used in a Klystron. It is built up out of ¼-inch aluminum rods, rather than of sheet metal, purely for convenience in construction. The cavity is frequency modulated, the frequency going from 34.5 to 39 megacycles and back, 20 times per second, or once for each burst of 300,000,000-volt electrons that comes out of the synchrotron. The electrons pass through the center of the cavity on each lap around the race track, receiving the electric kick which increases their energy. A given electron passes through about 450,000 times in being brought up to 300,000,000 volts.

Other synchrotrons are being built at the Massachusetts Institute of Technology, the University of California, and at the General Electric Co.

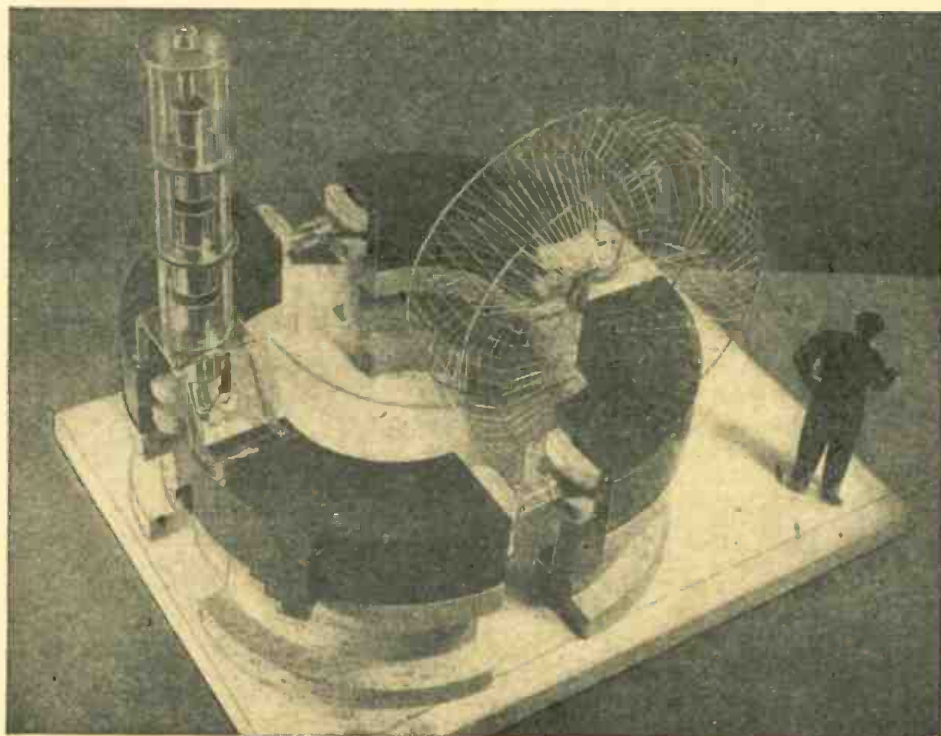

Model shows size of the five-ton synchrotron by comparison with the human figure at right.





*Our  
Honors  
to*  
**DR. de FOREST**

**\$5.00** for 10  
Output Transformers  
10 Given **FREE**

**\$5.00** Amplifier  
using 2-7C5, 7F7, 7Y4  
1 Given **FREE**

**\$4.00** 150 mill. Chokes  
1 Given **FREE**

**\$2.00** 96" Aerial  
1 Given **FREE**

**\$1.00** Tube No. 6SQ7  
1 Given **FREE**

**\$1.00** Tube No. 6K7  
1 Given **FREE**

**\$1.00** Tube No. 6D6  
1 Given **FREE**

**\$1.00** Tube No. 75  
1 Given **FREE**

**\$1.00** Filament Transformer  
2½ Volt 10 Amp.  
1 Given **FREE**

**\$1.00** 100 Resistors 2 watt

**\$1.00** for 4  
High Frequency Filters

*We pay shipping costs*

Thousands of parts  
and tubes in stock.  
Write us your needs.

Send check, money  
order or merely en-  
close currency (at  
your risk).

# RADIO CENTER

5834 West Warren Ave.  
Phone TYler 7-2720 and 7-5878  
DETROIT 10, MICHIGAN

## SIMPLE ELECTRONIC ORGAN

(Continued from page 113)

harmonics present. For example, no capacitance across the transformer produces a brilliant "string" tone; some capacitance, a more mellow "diapason" effect; and a large capacitor (2 $\mu$ f), a clear "flute" tone. Three of these four capacities are shunted across it by means of tablet-stop switches so that any desired degree of filtering may be obtained. Volume control is accomplished by three more tablet stops which switch in more or less resistance between the grid and cathode of the amplifier's input tube. A "swell" pedal for producing smooth crescendos is merely a foot-actuated potentiometer connected at the same point in the amplifier.

The tubes used in these circuits—both master oscillators and keying controls—may be practically any triode. The author used 6N7's because they consist of two triodes in the same envelope and consequently only half as many tubes are necessary, 6 for oscillators and 31 for keying controls, making a total of 37, exclusive of those in the amplifier and the rectifier-type power supply called for in Fig. 3.

It should again be emphasized that values of resistance and capacitance given in the diagrams are only approximate, and experiment with other values probably will be necessary exactly to duplicate the effects described.

## THE CINEMATIC ANALYZER

(Continued from page 66)

coupling are therefore used, with windings of Litzendraht wire on powdered-iron cores. The circuit itself has, no peculiarities worth mentioning, and is in all respects a straight i.f. amplifier.

### SOME SPECIAL POINTS

The voltages from the output of the selective amplifier are applied to the I.F. posts, where, by means of a shielded low-capacity coaxial cable they are applied to the vertical deflection plates of the oscilloscope.

However, in certain cases it is worth while to apply to these plates a detected signal. In these cases, the connections to the oscilloscope are still the I.F. posts. But the signals are detected by the 6H6 double-diode. The switch S2 is thrown to the downward position, closing the filament circuit of the 6H6. In its other position, the 6H6 heater circuit is broken and the secondary of the last 417-kc transformer is placed across the I.F. terminals.

When studying the audio end of a receiver, the signals brought out from it should be applied to the A.F. posts provided for that purpose.

Note also that when the analyzer is not used for panoramic reception, switch S1 permits cutting off the high-voltage supply from the stage used for that purpose.

Finally, for the study of receiver i.f.'s, and especially for making reso-

## Surplus — New Navy Oax Sonar Units Partially Assembled

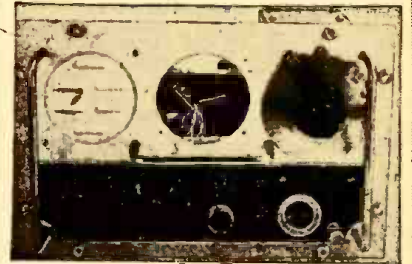

Each unit consists of the following:

- 1—4" Jensen PM4S Speaker
- 1—Power Transformer, 115 volt 60 cycle input, output 315-0-315 volts at 70 MA, 6.3 volts center tapped at 3.5 ampere, 5 volt at 3 ampere
- 1—Single variable condenser, 312 MMF with clock wise increase characteristics
- 1—Input Transformer
- 1—Output Transformer
- 1—Crowe 4" Dial
- 1—National Vernier Drive
- 1—IRC Attenuator, 100,000 impedance 3 DB per step to 57 DB, Type B-31P
- 9—Octal Sockets
- 2—2" Skirted knobs
- 1—DPST Toggle Switch
- 1—3 deck, 2 pole, 5 position each wafer switch.
- 1—Fuse post

Also a large quantity of assorted resistors, mica condensers, bathtub condensers, potentiometer, connectors, etc.

The unit was designed to use 1,6SJ7; 1,6SN76T; 1,6U66T; 1-5Y36T; 1,UR-150/30 Tubes are not supplied.

ONLY **\$750**  
F.O.B. N.Y.

## MARITIME SWITCHBOARD

336 CANAL STREET NEW YORK 13, N. Y.



1907-1947

We honor you, Dr. Lee de Forest on the occasion of the 40th anniversary of your vacuum tube, the historic audion.

1912-1947

We have been honored by having had the privilege of serving the radio electronic field for 35 years.

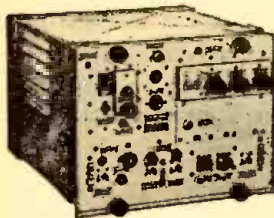

Transmitter and receiver has been widely used on the 144MC band. Just released from the Government as surplus. Shipping weight 100 lbs. Your price less tubes and power transformer.. **\$14.95**

Meters 0-5 MA. Western Electric 4" round case zero center .....\$3.95  
 Lip Mike with head band .....\$ .95  
 Meters 0-1 MA. Westinghouse 2" round case \$2.95  
 Meters 0-1 amp. R.F. Westinghouse 2" round case .....\$2.95  
 Coaxial cable—RG. 54 A/U-58 OHM per ft. .06

**TUBES**

6J4 .....\$1.50  
 6J6 .....\$ .95  
 956-9004 .....\$ .65  
 Sockets for Acron tubes .....\$ .19  
 VR 150 voltage regulators .....\$ .49

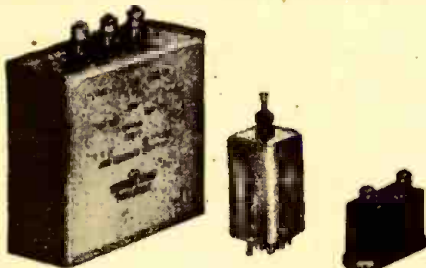

Condenser oil filled, hermetically sealed. 8.5-8.5 M.F.D., 1000 V.D.C., convertible to 4.25 MFD., 2000 V.D.C., 5/4" long, 2" wide, 5" high .....\$3.95  
 A wonderful coil which can be used on high frequency aluminum can. 30MC. I.F. transformer. Silver slug tuned .....\$ .29  
 Mica capacitor .002 M.F.D., 3000 V.D.C. ....\$ .89

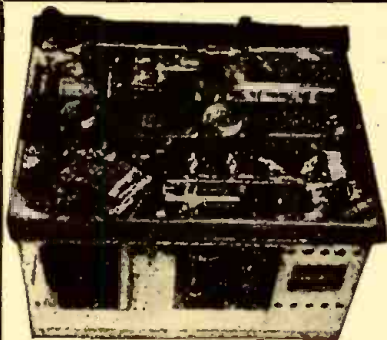

8CR522-100-156 MC. receiver and transmitter. Transmitter output 8-9 watts, voice amplitude modulated on any one of our crystal controlled frequencies. Receiver is readily switched to either one of the 4 present crystal-control channels. Tubes used: 2-832; 3-12A6; 1-6G6; 2-6SS7; 1-12J5GT; 1-12CB5; 1-9002; 3-9003; 1-12AH7GT; 3-12SG7. Price new—complete as shown \$59.95. Price used—complete as shown \$39.95.

**SELSYN MOTORS**

The ideal way of indicating the position of rotary beams, wind indicator, etc., line cord and instructions for 110 V.A.C. operation furnished. **2 for \$3.95**

**BLEEDERS**

75M. OHM—200 watt .....\$ .49  
 2500 OHM—100 watt adj. ....\$ .49  
 .20% deposit on all C.O.D. orders.

**HERSHEL RADIO COMPANY**

5249 GRAND RIVER  
 DETROIT 8, MICH.

Dynamotor Power Supply—inputs 6 or 12 V. output 500 VDC at 160 MA mounted on box with circuit breakers, relays, interference filter and two 10 foot cables. Army surplus. Shipping weight 84 lbs **\$9.95**



**TRANSFORMERS**

6.3V.—6 amps. 110 V.A.C.—60 cycle .....\$1.49  
 Thordarson 8 HY 150 M Choke .....\$ .95  
 12 HY 25 M Choke .....\$ .39  
 Thordarson Swing Choke 2-7 HY. 56-560 MA. In original box .....\$7.95  
 Thordarson 8HY, 175M choke. In original box \$1.49

**CONDENSERS**

100 M.M.F.D. variable A.P.C. type silver plated .....\$ .59  
 30 M.M.F.D. variable A.P.C. type silver plated .....\$ .25  
 12 M.M.F.D. variable 1/4" shaft .....\$ .30  
 Johnson neutralizing condenser for 250 TH. ....\$ .95  
 12 M.M.F.D. vacuum condenser—20,000 VDC 3.95  
 Filament Transformer 9.7V.—.5 amps.; 6.3V.—4 amps., 6.3V.—4.5 amps., pri. 110V 25 or 60 cy. ....\$1.95

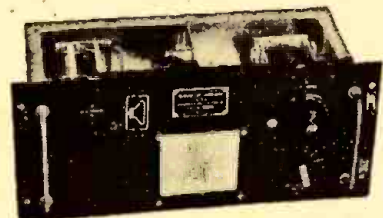

Tuning unit B.C. 375. Each unit has 3 double spaced unit cond. approximately 65 M.M.F.D. coils, SW chokes, national velvet dials and assorted mica condenser 2500 WVDC, over \$50.00 in parts. \$3.75

nance curves, the frequency-modulated 877-kc signal which is generated in the analyzer is brought out from the FM posts by means of a flexible shielded r.f. cable, to the end of which is attached a small metal box containing a 50,000-ohm potentiometer to permit regulation of the signal amplitude.

The power supply offers no problems. The high voltage may be rectified with a 5Z4 or any similar tube.

**ADJUSTING THE ANALYZER**

When the assembly is completed, check all connections carefully. It is then possible to go on to the adjustment, which requires an r.f. signal generator.

The I.F. posts are connected to the vertical deflexion input of an oscillator whose sweep is set at 60 cycles. The 6H6 is switched to the nonfunctioning position, as is the panoramic reception section. Applying a signal of 460 kc to the R.F. posts we should see a vertical image on the screen of the oscilloscope. The trimmers of the three last i.f. transformers of the analyzer are adjusted to give an image of maximum height. Then, with the controls of the oscilloscope, the image is brought to the center of the screen.

The frequency of the generator should now be varied, going down as far as 410 and up as far as 510 kc. The image on the cathode-ray tube screen should then be displaced to the left and right extremities of the screen, respectively. If they do not reach these points, the 877-kc oscillator is being frequency-  
 (Continued on page 127)

*Latest Listing of Electronic Apparatus  
 Up-to-date Catalog for Schools and Laboratories*

Our respectful congratulations to



Dr. Lee de Forest and his Audion

**GET OUR SPECIAL CATALOG OF ELECTRONIC INSTRUMENTS SELECTED FOR SUITABILITY IN SCHOOLS AND LABORATORIES**

—ALSO—  
**60-PAGE EXPERIMENTAL MANUAL FOR ELECTRONIC DEMONSTRATION**



BY  
**SOL D. PRENSKY**

• Write for FREE CATALOG of Selected Electronic Equipment, showing Multi-meters, Signal Generators, Oscilloscopes, Sound Amplifier Systems and Kits for radio and television sets.

To help you get the most out of your classroom Demonstrations, these practical directions are illustrated in complete detail. Available to school purchasers of test equipment at no extra cost.

• Send for Demonstration Experimental Manual—RD. Enclose \$2.00, which is refunded when any test equipment is purchased.

**NEW "TRANSVISION" TELEVISION KIT**

(Illustrated in our catalog) Complete Kit for 7" Picture and FM Sound—Excellent engineering for practical assembly. Includes special antenna tubes and all necessary data.



**TRANSVISION TELEVISION KIT. \$149.50**  
 complete with tubes .....  
 (Delivery in 10 wks. Send 25% for C.O.D. orders.)

**BASIC MICROAMMETER AND GALVANOMETER**



Used as zero-center galvanometer. 100-0-100 ua.

Also can be used as microammeter. 0-200 ua.

(Meter need not be opened at all)

Sensitive dual movement Westinghouse meter, ruggedly made for aircraft, each movement 200 ua. and independent. Two white-on-black scales furnished for pasting either one on outside of glass. Makes a fine foundation unit for a multimeter.

Westinghouse Dual Micro-ammeter-WD ..... \$6.50  
 (Send \$1 if wanted C.O.D.)

**RADIOLAB PUBLISHING & SUPPLY CO.**  
 652 Montgomery Street  
 Brooklyn 25, N. Y.



## GENERAL ELECTRIC 150-WATT TRANSMITTERS ... NOW ONLY \$44.50

These units manufactured for the Army Air Forces during the war by General Electric are now available at a price every amateur can afford. They are the same brand new transmitter, complete with seven plug-in tuning units, antenna tuning unit, dynamotor, connector plugs, cables, all tubes, and instruction book, which sold for as high as \$175.00 last year. These transmitters have a frequency range of 200-500 Kc. and 1500-12,000 Kc. and will operate on the 10 and 20-meter bands with slight modification. Instruction booklet for conversion to 110V, 60-Cycle is also included. Transmitter dimensions are 21½ x 23 x 9½ inches. Total shipping weight 250 lbs. Obtain yours NOW for the lowest price at which this model has ever been sold COMPLETE ..... \$44.50

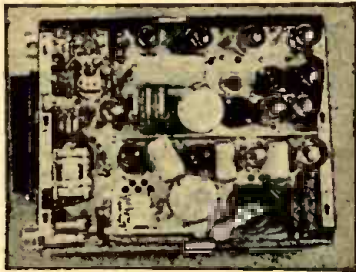
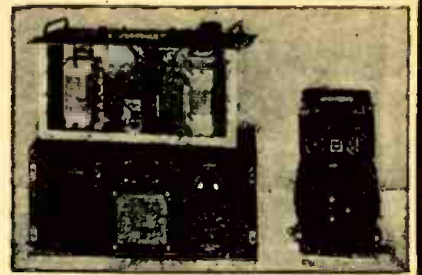
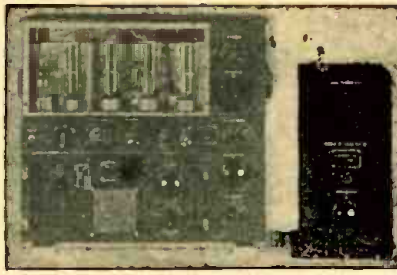

**General Electric RT-1248 15-Tube Transmitter-Receiver**  
**TERRIFIC POWER (20 Watts)** on any 2 instantly selected, easily pre-adjusted frequencies from 435 to 500 Megacycles. Transmitter uses 3 tubes including a Western Electric 318 A as final. Receiver uses 10 tubes including 855's as first detector and oscillator, and 3-7H7's as IF's, with 4 slug-tuned 40 MC. IF transformers, plus a 7H7, 7E8's, and 7F7's. In addition unit contains 3 relays designed to operate any sort of external equipment when actuated by a received signal from a similar set elsewhere. Originally designed for 12V operation, power supply is not included, as it is a cinch for any amateur to connect this unit for 110V AC, using any supply capable of 400V DC at 15 MA. The ideal unit for telephone use as in a taxicab, or for any kind of remote control applications as with drone airplanes. Instructions and diagrams supplied for running the RT-1248 transmitter on either code or voice, and for using the receiver as either an AM or FM set. As an FM set, the receiver section of the 1248 is capable of better results than almost any of the commercial FM sets on the market, largely as a result of the superb engineering and meticulous workmanship employed in constructing the converter, oscillator and IF sections. Supplied in original cartons with 15 tubes. Your cost \$29.85—10% less if ordered in lots of 2 or more. If desired for marine or mobile use, the dynamotor, which will work on either 12 or 24 VDC and supply all power for the set, is only \$15.00 additional.

## Famous Collins Autotune Transmitter

This is the well known unit used in Army and Navy planes that features automatic motor tuning of any of 11 front-panel preselected frequencies up to 18,100 Kc. as well as manual tuning at any time. The transmitter operates on voice, CW, and MCW on all frequencies. This beautifully designed unit uses an 813 final, and push-pull 811's as modulator, measures 23½x13¼x11, and weighs 70 lbs. Estimated average power output is 150 Watts. Price including dynamotor—\$185.00. Write for literature describing any units you wish more information on.

## BENDIX SCR-522

Very High Frequency Voice Transmitter-Receiver—100-to-156 MC. **THIS JOB WAS GOOD ENOUGH FOR THE JOINT COMMAND TO MAKE IT STANDARD EQUIPMENT IN EVERYTHING THAT FLEW EVEN THOUGH EACH SET COST THE GOVT. \$2500.00.** Crystal Controlled and Amplitude Modulated—High Transmitter Output and 3 Microvolt Receiver Sensitivity gave good communication up to 180 miles at high altitudes. Receiver has 10 tubes and transmitter 7 tubes, including 2-832's. Furnished complete with 17 tubes AND POWER SUPPLY for 12 or 24 volts, also remote control boxes and cable connectors. We include complete diagrams and instructions for the simple conversion of the 522 to full 110-Volt, 60-Cycle operation. Your cost \$44.50

## Six Band Communications Receiver

Featuring continuous coverage from 1500 Kc to 18,000 Kc on a direct reading dial with the finest vernier drive to be found on any radio at any price—extreme sensitivity with a high degree of stability—crystal filter and phasing control—BFO—antenna compensation—transmit-receive relay—standard 6 volt tubes. Contains a plate supply dynamotor in compartment within the handsome black crackle finish cabinet, the removal of which leaves plenty of room for installation of a 110V, 60 or 25 cycle supply. These new receivers, which make any civilian communications receiver priced under \$200.00 look cheap and shabby by comparison, are only \$44.50. Power supply kit for conversion to 110V, 60 Cycle, is only \$8.50 additional.

## 14 Tubes UHF Superheterodyne Receiver

This beautifully constructed receiver was designed especially for Signal Corps communication service, and is one of the finest and most sensitive sets ever manufactured. Operating from 110V 60 Cycles, this set has two tuned RF stages, tuned converter and oscillator, FIVE slug tuned I.F. stages, diode detector, tuning eye, and a two-stage amplifier that will drive a speaker or phones. The frequency range is 158-210 Mcs. It is a simple matter to operate on other bands by making a slight alteration in the tuning coils. A complete set of tubes is included with each receiver, along with a circuit diagram and parts list. The high-voltage power supply delivers 150 milliamperes, and is well filtered by a heavy-duty choke and three 7 Mfd. oil-filled condensers. This buy of a lifetime cost the government about \$700. Amateurs and experimenters will never again be able to purchase fine equipment at such a tremendous saving! Only \$39.95.

**BUFFALO RADIO SUPPLY • 219-221 Genesee St., Dept. 1C • Buffalo 3, N. Y.**

through T1 and a coaxial line to the sound unit. The unit consists of a two-stage i.f. amplifier, limiter and discriminator. Only one stage of limiting is used but has been found adequate. No audio amplifier is included since most present day broadcast receivers contain a phonograph input connection to which the output of the discriminator can be connected, thus saving the additional equipment required for an audio amplifier.

Photo B shows the complete television receiver. The large chassis contains the mixer, h.f. oscillator, all video circuits, the sweep circuits, the high-voltage

Photo C, below—Rear view of set, especially showing tube mount.  
 Photo D, right—Top view, layout coded to agree with parts list.

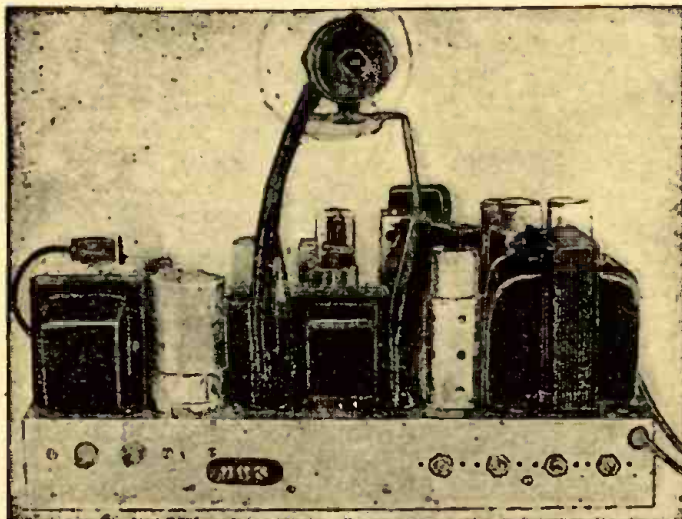

## BUILDING A TELEVISER

(Continued from page 61)

power supply, and one low-voltage power supply. The small chassis in the middle contains the FM sound unit. The power supply for this unit is built on the chassis to the right in Photo B. The chassis measure 16½ x 14½ x 2½; 7½ x 7 x 2½; and 5x8½x1½ inches.

Six controls are mounted on the

front of the main chassis. These are from left to right in the photos: focus control R97, power switch SW (rotary type), contrast control R3, brightness control R44, channel switch, and oscillator tuning control C7.

Two jacks are mounted on the front of the sound unit (center, Photo B). The jack on the left is for audio output while the coaxial connector on the right is for the i.f. signal input from the main

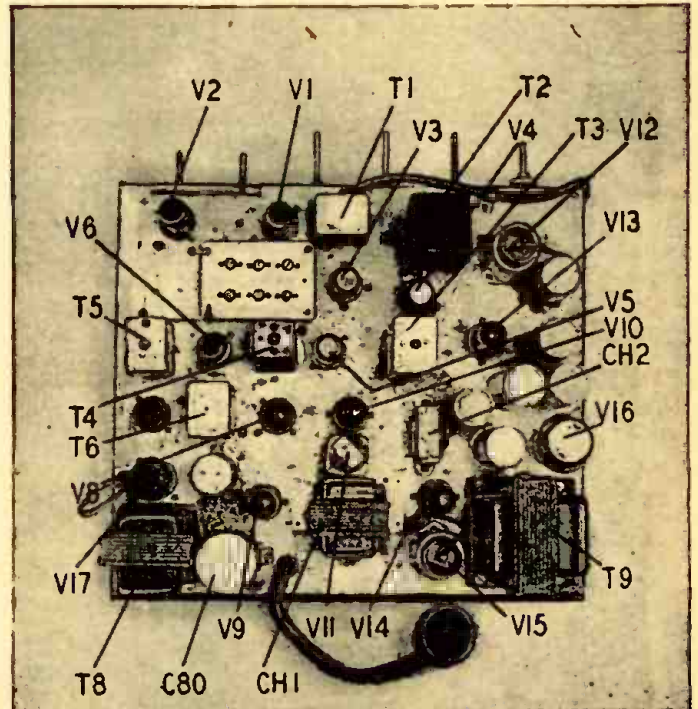



**MOST —  
OFTEN —  
NEEDED**

# RADIO DIAGRAMS

We salute Dr. Lee de Forest, a pioneer and leader in radio.



**Covering 1946, 1942, 1941, 1940, 1939, | | 1926-1938**

Each manual contains between 192 and 240 pages. Price each \$2.00

This volume \$2.50

Service radios faster, better, easier, save money and time, use these most-often-needed diagram manuals to get ahead in radio servicing. Clearly printed circuits, parts lists, alignment data, service hints are the facts you need to improve your servicing ability. Save hours each day, every day, let these six volumes furnish diagrams for 80% of all sets you will service.

**See Your Radio Jobber or Send Coupon** →

## Supreme Publications

PUBLISHERS OF RADIO BOOKS, MANUALS, AND DIAGRAMS

9 S. KEDZIE AVE.

CHICAGO 12, ILL.

chassis. The power input plug is mounted on the rear of the sound chassis. The power plug and cord are shown connected to the terminal strip on the end of the sound unit power supply.

The 5BP4 picture tube is mounted above the main chassis in a metal shield constructed of light sheet iron, which serves to keep stray magnetic fields from affecting the picture. Four rubber grommets at each end of the shield support the tube and prevent it from touching the metal. The shield is 13½ inches long and measures 5¼ inches in diameter at the large end and 2 inches at the small end. The shield support (Photo C) is a U-shaped bracket 10 inches high.

The parts should be laid out and mounted on the various chassis before wiring is begun. The best schedule for wiring is to wire the power supplies first, then the sweep circuits for the picture tube, and last the video and sound circuits of the receiver. Each circuit should be checked as far as possible for operation after wiring is completed.

A layout of parts on the main chassis can be seen in Photo D. Parts are mounted as close as possible to insure the shortest leads when wiring. This is especially true in the r.f. portion of the receiver. The power supply components are to the rear of the main chassis with the positioning controls R90 and R91 located on the rear of the chassis since they are seldom used (Photo C). Con-

*(Continued on following page)*

### NO RISK TRIAL ORDER COUPON

SUPREME PUBLICATIONS, 9 S. Kedzie Ave., Chicago 12, ILL.

Ship the following manuals: (Money back guaranteed)

1946    1942    1941    1940    1939    1926-1938

Price each volume only \$2.00, postpaid    \$2.50

I am enclosing \$..... send postpaid.

Send C.O.D. I am enclosing \$..... deposit.

Name: .....

Address: .....

## Look at Our Specials at Lower Prices!

### Army Aircraft Receivers BC-946-B

Broadcast band from 520 to 1500 Kc. tube complement: 3-12SK7, 1-12SR7, 1-12A6, 1-12K8; can be used with 24 V dynamotor supplying A & B power; can be converted to AC or DC or 32 volt sets; 3 stages of IF used. Uses 3 gang condenser. Each Complete with tubes and schematic.

**\$12.95**

### Signal Corps Receivers

6 tubes: 3-12SK7, 1-12SR7, 1-12A6, 1-12K8 190-550 Kc (specify freq. desired) 3-6mc; power 28 VDC, mfd. by Western Elec. etc. Ship. wt. 19 lbs. Original cost \$99.23. Complete with tubes, whole receiver at cost of tubes only. Slightly used \$6.95 —your cost each .....

**\$6.95**

HICKOK 2½" 0-150 Volt AC Voltmeter each .....\$2.49 lots of 10 .....\$22.50

### Signal Corps Radio Receiver

BC-857-B 2 tube set—1-12SQ7; 1-12C8; original price \$18.75; ship. wt. 5 lbs. Your COST (less tubes) .. **\$3.95**

**3½" G. E. AUTOMATIC TIME METER**  
60 cycle 110 volts. This time meter consists of a cyclometer driven by a telechron synchronous motor. Connect to an electric circuit; it will measure and indicate the number of hours, tens of hours or minutes that the circuit is in use. Ship. wt. 6 lbs. list \$17.00. **\$4.95**  
YOUR COST

### SUPREME FOUNDATION METER

40 Micro Amps. 20,000 ohms per volt. 4¼" square. Manufactured by Supreme Instruments Corp. Each ..... **\$8.95**

plus shipping charges  
DEPT. D

## → ARROW SALES, INC. ←

59 W. HUBBARD ST., CHICAGO 10, ILL.  
Telephone: Superior 5575



**LIBERTY'S TRIBUTE TO  
DR. LEE DE FOREST**

"He has made radio entertainment available to millions—his research launched an industry."

*Liberty Leads in*  
**RADIO PARTS  
and  
EQUIPMENT**

**SIGNAL CORPS JACK BOX  
BC-1366**

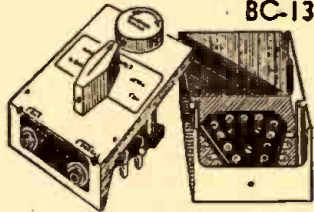

Cast aluminum box held together by 11 banana plugs; 2 jacks, 1 single and 1 double circuit, potentiometer, and double deck hand switch. Single unit 59c. Lots of 10 45c. Lots of 100 38c.

**SIGNAL CORPS RADIO RECEIVER  
BC-946-B**

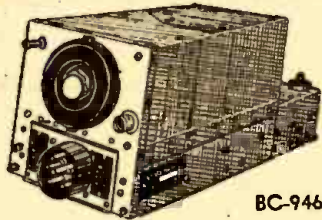

Broadcast band from 520 to 1500 Kc. tube complement: 3-12SK7, 1-12SR7, 1-12A6, 1-12K8; can be used with 24V dynamotor supplying A and B power; can be converted to AC or DC or 32 Volt sets; 3 stages of I.F. used. Uses 3 gang condenser. Complete with tubes and schematic. \$16.95

**RECORD CHANGERS**

Detroit—late model .....\$16.50 net  
Crescent—late model .....\$17.50 net

**RADIO KITS**

6 Tube "Super Het".....\$14.95  
5 Tube "Super-Het" AC-DC.....\$12.95  
Special 5 Tube "Super Het" with Slide Rule Dial .....\$19.95

**OIL FILLED CAPACITORS**

2 mfd-1000 V.....\$1.60  
4 mfd-1000 V.....\$2.20  
8 mfd-1500 V.....\$2.80  
8 mfd-600 V.....\$1.90  
2 mfd-1500 V.....\$2.20

**VOLUME CONTROLS**

50 ohm	10M ohm	200M ohm
100 ohm	20M ohm	1 meg
700 ohm	40M ohm	2 meg
1000 ohm	50M ohm	25 meg ohm
5000 ohm	100M ohm	Your cost 25c ea.

Duals—your cost 35c each.  
100M-100. meg ohm 100 meg-15 ohm  
25% Deposit with order, Minimum order \$2.00.

**LIBERTY SALES CO., INC.**  
115 WEST BROADWAY · NEW YORK 13, N. Y.

**BUILDING A TELEVISER**

(Continued from page 119)

trols R90 and R91 as well as focus control R97 are insulated from the chassis because they are at a high potential above ground. When wiring the high-voltage power supply, precautions should be taken to adequately insulate all wiring to insure against short circuits in the receiver (and also against possible fatal shock to the builder!).

The sweep circuit oscillators and amplifiers together with the synchronizing circuits are located on the right side of the main chassis as shown in Fig. 10. The height and width controls R60 and R86 as well as the horizontal and vertical hold controls R76 and R56 are mounted on the rear of the chassis (Photo C).

When wiring the r.f. portion of the receiver, attention should be given to short leads and good grounds. This is particularly important in the mixer and h.f. oscillator stages since these circuits operate at comparatively high frequencies. If oscillator leads are not kept short, difficulty will be found in getting the oscillator to tune above 90 mc. It was found that with certain wiring conditions even a straight piece of wire 2 inches long had too much inductance to enable the oscillator to be tuned to 90 mc.

The second part of this article, which will appear in an early issue, will describe the construction of a complete FM television sound receiver, with all data necessary for winding the r.f. coils and i.f. transformers. A complete parts list will be published in that installment.

**TRAINEE FIVE RADIO**

(Continued from page 86)

volume and correct position on the dial. As the tuning condenser is of the cut-plate type, made especially for a broadcast-band superheterodyne, there is no padder to adjust and very good tracking is achieved. As a final warning, common sense must be used. Long plate or grid leads will result in oscillation and much grief.

Amateurs may attain the number of 250,000 in the near future, predicts John Reinartz, head of RCA's amateur activities. Captain Reinartz attributes the increase in operators to the fact that many returning servicemen became versed in electronics during the war and an equally large number were engaged in radio and radar manufacturing jobs.

**NEW CATHODE-RAY TUBES**

5CP1's in original sealed cartons, \$7.95 each, 12 pin diaphanous socket for ECP1 when bought with tube, 45c each; otherwise, 90c each. New 5CP1 steel shields, cadmium plated, 85c each. Include shipping postage in your money order. 5CP1—5-lb.: shield, 3-lb. New 954, 955, 956 and 957 Acorn tubes in original cartons, not rejects, 89c each, postpaid in U. S. Write for free electronic bargain list.  
**OHMEYER ENGINEERING LABS.**  
Fairview Blvd. Dept. K Hempstead, N. Y.

**"HARD-TO-GET PARTS"**

**POWERFUL ALL-PURPOSE INDUCTION MOTOR**

IDEAL FOR EXPERIMENTERS—101 USES



Sturdily constructed to precision standards, this self-starting shaded pole A.C. induction motor is powerful enough for a number of uses. Some of these are: Automatic Timing Devices, Current Interrupters, Electric Fans, Electric Chimes, Window Displays, Photocell Control Devices, Electric Vibrators, Small Grinders, Buffers and Polishers, Miniature Pumps, Mechanical Models, Sirens, and other applications.

Consumes about 15 watts of power and has a speed of 3,000 r.p.m. When geared down, this sturdy unit will constantly operate an 18-inch turntable loaded with 200 lbs. dead weight—THAT'S POWER!  
Dimensions: high by 2 1/4" deep; has 4 convenient mounting studs; shaft is 7/8" long by 3/16" diameter, and runs in self-aligning oil-retaining bearings. Designed for 110-220 volts, 50-60 cycles, A.C. only. Sbd. Wt. 2 lbs.

ITEM NO. 147  
YOUR PRICE ..... \$2.95

**ULTRA MAGNET**

LIFTS MORE THAN 20 TIMES ITS OWN WEIGHT  
**LITTLE GIANT MAGNET**



Lifts 5 lbs. easily. Weighs 4 oz. Made of ALNICO new magnetic steel. Complete with keeper. World's most powerful magnet ever made. The experimenter and hobbyist will find hundreds of excellent uses for this high quality permanent magnet. Measures 1 1/4" x 1 1/4" Sbd. Wt. 1/2 lb.

ITEM NO. 159  
YOUR PRICE ..... \$1.50

**THE MAGIC ELECTRIC WELDER**

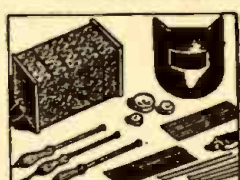

Here is one of the most compact, practical welders we have ever seen. BRAZES, SOLDER, CUTS ALL METALS. ANY ONE CAN OPERATE IT. Repairs steel, cast iron, aluminum, brass, copper, bronze, etc. Complete with power unit, flame and metallic arc attachments. 110 volts AC or DC. For hobbyist or professional. COMPLETE SAFETY IS ASSURED. NOTHING ELSE TO BUY. BRAND NEW OUTFIT. Guaranteed for one year. Simple instructions with each set.

ITEM NO. 158  
YOUR PRICE ..... \$19.95

**AMAZING BLACK LIGHT!!**

Powerful 250-Watt Ultra-Violet Source



The best and most practical source of ultra-violet light for general experimental and entertainment use. Makes all fluorescent substances brilliantly luminescent. No transformers of any kind needed. Fits any standard lamp socket. Brings out beautiful opalescent hues in various types of materials. Swell for amateur parties, plays, etc.; to obtain unique lighting effects. Sbd. only. Sbd. Wt. 1 lb.

ITEM NO. 87  
YOUR PRICE ..... \$1.95

**WESTERN ELECTRIC BREAST MIKE**

This is a fine light-weight aircraft carbon microphone. It weighs only 1 lb.



Mike comes with breastplate mounting and has 2-way swiveling adjustment so that it can be adjusted to any desired position. There are 2 woven straps; one goes around neck, the other around chest. Straps can be snapped on and off quickly by an ingenious arrangement. This excellent mike can be adapted for home broadcasting or private communication systems. By dismounting breastplate, it can be used as desk mike.

Comes complete with 6-foot cord and hard rubber plug. Finished in aneroidized plate, non-rustable. Shipping weight, 2 lbs.  
ITEM 152  
YOUR PRICE ..... \$1.49

**WATTHOUR METER**

Completely overhauled and ready for immediate service. Designed for regular 110-volt, 60 cycle 2-wire A.C. circuit. Simple to install; 2 wires from the line and 2 wires to the load. Sturdily constructed in heavy metal case. 8 1/2" high, 6 1/4" wide, 6" deep. Working house, G. E. Wayne, Sagamo or other available make Sbd. Wt. 14 lbs.

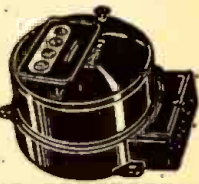

ITEM NO. 33  
YOUR PRICE ..... \$5.95

**HUDSON SPECIALTIES CO.**  
40 West Broadway, Dept. RC-1-47, New York 7, N. Y.

I have circled below the numbers of the items I'm ordering. My full remittance of \$..... (No C.O.D. ORDERS UNLESS ACCOMPANIED WITH A DEPOSIT.) OR my deposit of \$..... is enclosed (20% required), ship order C.O.D. for balance. NO C.O.D. ORDER FOR LESS THAN \$5.00. BE SURE TO INCLUDE SHIPPING CHARGES.  
Circle item No. wanted:  
147 159 158 87 152 33

Name .....

Address ..... Please Print Clearly

City ..... State .....



# "TAB"

That's A Buy



**CRYSTALS MTD "AT" CUT NEW GTD 85c@; 4 for \$3**

6250 to 8750 (6mtr) .....  
6797 to 6863 (11mtr) .....  
7000 to 7425 (20. 10mtr.) .....  
8335 to 9000 (6mtr) .....

**ACTIVE OSC'S GTD**

DC-9 STD 1000KC ± 10cy \$5.95  
DC-15A STD200KC ± 10 cy 5.95  
100KC STD ..... 7.20

Condor kit qty silver mica: 50 for ..... \$2.00  
Resistor kit 100BT 1/4 & 1W: 50 to 2 megohms... 2.50  
Control kit ABJ: 50 to 2 meg: 10 for ..... 2.50  
Kurman 1000KC Hummer, op. 6-8V (\$9) ..... .97  
Cased Hmically sealed Transformer Pri 50/800cy 105-125 & 80V; Sec 1000VCT & 300/110ma. 6.3V/5A, 5V/3A, 6.3V/.65A, 6.3V/.65A, 6.3V/1.25A & Two cased H scaled 10Hy/110ma chokes & Two Condors 3mfd/330VAC 1000WVDC Pyranol & RK60 & socket ..... 9.00  
Raytheon cased 840VCT/110ma, 630VCT/121ma, 5V/3A, 5V/3A, 6.3V/1A, 6.3V/.6A, 115V/60Pri & Two 10Hy/110ma H scaled chokes & oil Condors 2/2.5mfd & 5mfd/600WVDC oil... 5.95  
Thermador Cased SC Rated Cont 3800VCT/6KW/2.7 Amps, Primary 200, 210, 220, 230, 240, 440: 50/80cy (\$365) "TAB" SPECIAL 45.00  
Collins cased 6Hy/1.2Amps/12500WV ..... 16.00  
Amphenol octal sockets mica B SSTN 25 for .. 1.50  
Cinch Local sockets with saddle 21 for ..... 1.50  
Amphenol Maginal sockets 49S11L ..... .39  
Condor GE Pyranol 15mfd/330VAC/1000WVDC 2.75  
Condor GE Pyranol 30mfd/660VAC (3 units) 8.10  
Condor Westghe 2mfd/12500WVDC (\$210) ..... 25.00  
Condor Westghe 1mfd/25000WVDC (\$395) ..... 75.00

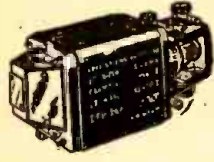

**NEW NAVY DYNAMOTORS EICOR DC GTD overseas packed. AN insp H1-eff. CONT. duty. Input 12V/4A or 24V/2A, output 500V/50ma: Input 12V/8A or 24V/4A output 275V 110 ma & 12V/3A. Either UNIT \$4.95 or both units (2) & filter \$3.49. Wgt. 9 lbs. 7/8" L x 2 1/4" H x 4 1/4" W. Adaptable to 6V operation. Alnico Field.**

Cathode Ray Transf Pri 115V/60cy: See 1000VCT .045ma & 795/360V/.08ma, 5V/3A, 5V/3A, 6.8V/1A, 6.8V/0.3A & 3BP1 tube & socket ..... \$7.50  
Littelfuse 250ma/3AG (LP.25) 48 for ..... 1.00



**WESTON MODEL 796**

Portable insulation tester and megger NEW NAVY termination. Tests insulation and resistance up to 200 megohms, test potential 350 to 500 vdc. Resistance 0.20-200 megohms .5 and 5 megohm center scale. 4" sq. 50 microamp mtr. less batteries, test leads and carrying case (LP \$100) ..... \$16.95  
with carrying case \$24.75; Parts for 500V-AC supply \$9.

**IF YOU DONT SEE IT—WRITE FOR IT**

Crystals 1N21, 22, 23, 25 GTD 4 for ..... \$1.50  
Condor oil 20 mfd/600WVDC (1-2-4-5-8mfd) ..... 1.50  
L-3 Perm Mag 6" hvy duty Spkrs (LN) ..... 4.95

\$2 Min. order FOB N.Y.C. Add Postage all orders and 25% deposit. Whitehall 3-3557. Send for catalog 300. Specialists in International Export. School, College & industrial trade. Money Back Guarantee.

RCA 808 JAN-CRC New Q'd P11 7.5v /4amp. Plate 1500V/200 Watts, Rated 140 Watts output each "UHF" (List \$7.75) "TAB" \$2.75@; 2 for ..... \$5.00  
GE&WST 807 \$1.35@; 2 for 2.50  
829B/3E20 & socket ..... 4.50  
GEARAY 958 ca 65c; 2 for .. 1.25  
RCA 958 & Socket ..... 1.25  
957 or 958A & Socket ca ..... 1.25  
805/905 & Socket \$6. 2 for 11.00  
GE484/2C4(LK)house (\$11) 6.95  
GE845 & Sockets \$7.50, 2 for 14.00  
NU 2V3G/16500V Rect (\$3.00) .75  
RCA 6AC7 Boxed new 4 for 3.00  
2C26 UHF (LPS5) ..... 1.95  
6AK8 boxed \$1.25@; 2 for ..... 2.00  
6AG5 boxed 75c@; 2 for ..... 1.30  
3rd new (LPS2.50) ..... .65  
9008 (LPS1.60) 70c 2 for ..... 1.25



872A New & socket. Two for ..... \$5.75  
VR150 New (LP \$3.20) .85@; 2 for ..... 1.50  
3BP1 or 5BP4 New & socket ..... 9.95  
3CP1 & socket \$7.50, 3BP1 & socket ..... 3.95  
6SN7 new (\$1.80) .80@; 2 for ..... 1.45  
6J5 new (LP \$1.85) 65@; 2 for ..... 1.20  
6V6 new (LP \$1.50) 83@; 2 for ..... 1.60  
6C4 new (LP \$1.80) 75@; 2 for ..... 1.40  
2X2 new (LP \$3.20) \$1; 2 for ..... 1.80  
1D21/631-P1 STROBOTRON (LP \$6) ..... 4.50  
WE703A tube UHF/1000mc's (LP \$40) ..... 5.95  
WE307A RF Pentode (LP \$13) ..... 5.95  
WE309A RF Pentode (LP \$24) ..... 6.95  
WE717A Door Knob tube new (\$7.50) ..... 1.95  
1825 New beam (S'807) 78c; 2 for ..... 1.50  
RCA-30 (LP \$1.85) 65@; 2 for ..... 1.10  
RCA-1E7G (LP \$3.20) \$1.50@; 2 for ..... 2.50  
RCA-614 UHF (\$9.50) ..... 2.49  
6G5/6U5 RAY ore tubes (LP \$1.80) 2 for ..... 1.00  
9002 New boxed RCA (LP \$2.50) 2 for ..... 1.10  
GE 1641/RK60 new FW H. V. Rect (\$2.75) 1.95  
RX215 Raytheon new FW 500V/15Amp (LP \$24) ..... 7.95  
GE Vacuum Condor 50mmfd/18000V ..... 3.95  
New TBY Vibrator pack and S' Battery, Manual 9.95

Raytheon 866A filament transformer 115V 60c pri, 2.5V 71A sec and Two new RCA 866A tubes .55.90  
With Millen caps and sockets \$7.00  
Raytheon Transformer only \$3.25



Combination Two 872A's KENYON TNSF. SOCKETS New gtd . \$12.00

**"TAB" • DEPT. RC1, 6A CHURCH ST., NEW YORK 6, N.Y., U.S.A. • "TAB"**

than the radiator (which is an electrical half-wave) and the director is shorter. A difference of about 5 percent in each case is found to give maximum effects.

The length of a parasitic element varies somewhat with its distance from the radiator, and the radiation resistance decreases as this distance becomes shorter. It is usual to build a reflector a quarter wavelength behind the radiator and to place a director at about .1 wavelength in front of it, thus forming a three-element beam. By rotating the assembly, the beam may be pointed in any direction.

A commercially-designed 146 mc array is shown in Fig. 2. This antenna is made to be assembled as a six-element beam antenna. The figure shows only one bay, comprising one radiator, reflector and director. The other three corresponding elements are located at the other end of the horizontal support. The radiators are fed in phase from a coaxial cable which is led up the vertical pipe and through each arm of the horizontal support. Since the two bays are fed in phase, they must be separated by a half-wavelength.

Each element is made of half-inch aluminum tubing, sealed with spherical tips on the ends and rigidly supported to withstand wind and ice. This is important if wobbly signals are to be avoided. The mast can be made rotatable, usually a requirement for amateur and listener use.

The high power-gain obtained from the six-element beam antenna is illus-

**ANTENNA PRINCIPLES**

(Continued from page 72)

trated in Fig. 3. The horizontal plane pattern shows distance vs. angle from the forward direction of the array. The pattern shows that the signal level say 10 miles from the array in the forward (0-degree angle) direction can be received at half this distance, only within a restricted angle of 64 degrees. Outside this angle, the signal strength is greatly reduced. With this

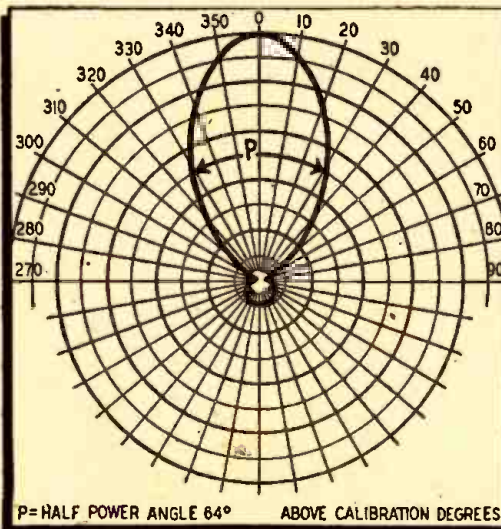

array, a 10-watt transmitter gives the same output in the favored direction as does 60 watts with a non-directional radiator.

The simple dipole can be greatly improved and certain of its disadvantages overcome by using specially designed antennas derived from it.

The J antenna shown in Fig. 4 is a popular one among amateurs. It consists of a dipole connected to a lower matching section. This section may be considered to be another half-wave bent

(Continued on following page)

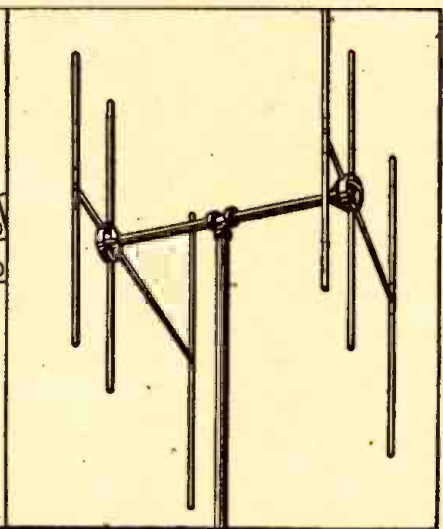

Courtesy Workshop Associates, Inc.

Fig. 3—The complete antenna of Fig. 2 with a radiation pattern showing its directivity.



# LEEDS

**CAN ALWAYS BE RELIED ON FOR EXCELLENT VALUE AND SERVICE**  
**ARMY RADIO PHONES**

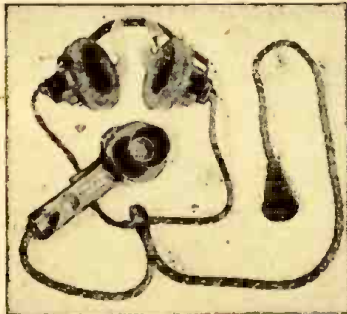

They're perfect and were O.K.'d by Signal Corps inspectors. For battery-less phone or recordings, etc. Complete dynamic hand mike, 2 earphones, head-band, cord set and special connecting cord set. A real special ..... ONLY **\$345**

## GYRO—2 1/2 VOLT STABILIZER



Used on 1000-lb. bomb. Complete with motor, relay—gyro ..... \$5.00

## CONDENSERS

10 Mfd	600v DC	\$1.50
2 Mfd	2000v DC	2.25
1 Mfd	5000v DC	4.95
2 Mfd	1000v DC	.95
10 Mfd	1500v DC	3.49
0.1 Mfd	7500v DC	1.50

G.E. 4" SQUARE METERS. Bakelite case; 100-0-100 microamps. Illuminated Dial. Very special ..... \$5.50

COAXIAL CABLE, 52 ohm; 100 ft. ... \$5.00  
 68-74 mc RF oscillator with tube ..... .50

CPI CATHODE-RAY TUBE: new, in sealed carton ..... \$2.95  
 14-prong low loss socket for above ..... .50

CRYSTALS 40 & 80 meter bands mounted in holder ..... 1.00

Complete stock on hand of

**NATIONAL CO. Products**  
**TRIPLETT Instruments**  
**and Panel Meters**

If not rated 25% with order, balance C.O.D.  
 All prices F.O.B. our warehouse New York.  
 No order under \$2.00

We ship to any part of the globe

# LEEDS RADIO CO.

75 Vesey St., Dept. J-2

COntland 7-2612

New York City 7

## ANTENNA PRINCIPLES

(Continued from page 121)

to form two parallel conductors. As described in the previous article, voltage loops appear at each end of a half-wave section and a voltage node appears at the center. Therefore, high-voltage points are obtained at the upper ends of the matching section and practically zero voltage at the lower or closed end. Consequently, the radiator (upper part

of the matching section (bottom of the J) it is evidently possible to find any desired impedance somewhere along the section. This may be done by experiment.

The feeders must be attached at those points where the ratio of maximum to minimum voltage along the feeders is as small as possible. It may be determined by use of a vacuum-tube voltmeter or an r.f. ammeter moved along the lines. When the voltmeter or ammeter shows as nearly as possible a constant value all the way down the feeder lines, the impedance is correctly matched, and maximum output is being obtained.

## COAXIAL ANTENNA

The two conductors of the J matching section are not actually balanced because one connects to a dipole and the other is left open. Under these circumstances the two currents cannot be exactly equal in each conductor. Because of this, there is some radiation from the matching section as well as the dipole, and the reaction between them distorts the doughnut pattern and may cause power to be radiated upwards. This is undesirable where local coverage is important, as in police radio and general amateur work.

The coaxial antenna, designed to eliminate much of this difficulty, is shown in Fig. 5. It is a combination of coaxial feeder and a dipole antenna. The inner conductor of the feeder is ex-

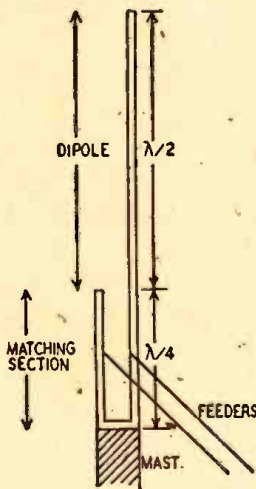

Fig. 4—The "J" antenna is employed widely.

of the antenna) can be connected directly to one end of the matching section. Actually, of course, the entire antenna, consisting of radiator and matching section is made of one piece of heavy aluminum or brass tubing, or of two parallel conductors connected at their bottom end.

Since the voltage is high at the upper ends of the matching section these points are at high impedance, while the impedance at the bottom of the J is

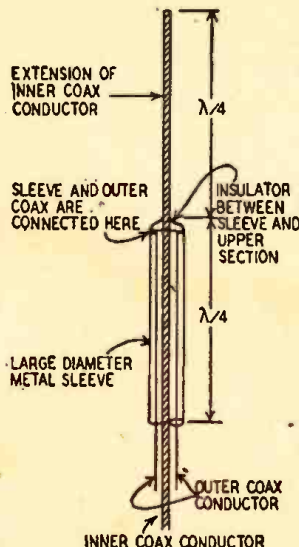

Fig. 5—Construction of the co-axial antenna.

almost zero. This means that the entire antenna can be directly grounded or connected to a grounded mast, thus eliminating insulation and mounting problems. Also, since the impedance increases gradually from the closed end

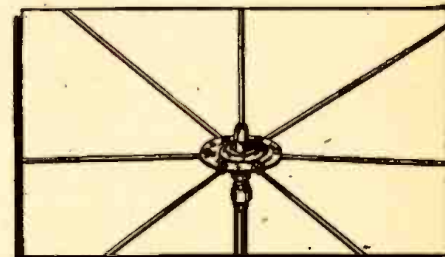
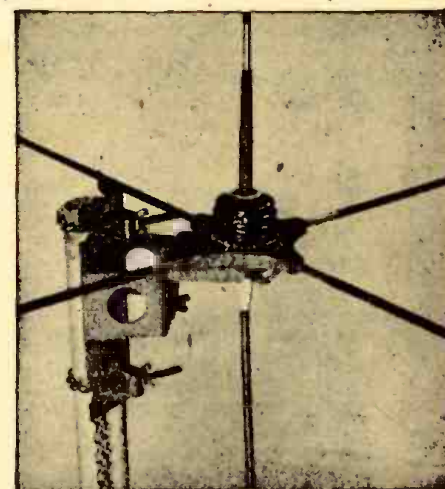

Fig. 6—High-frequency ground-plane antenna.



The rods are changed to change frequency.



tended by a quarter-wave and this becomes the *upper half* of the dipole radiator. The outer coaxial conductor is connected to a large diameter *sleeve* which becomes the *lower half* of the dipole. The sleeve (like the upper portion) must be a quarter-wave long electrically. Because of its wide diameter, however, its length is generally much less than this physically, and must be determined by experiment or calculation.

In this antenna, fields due to the

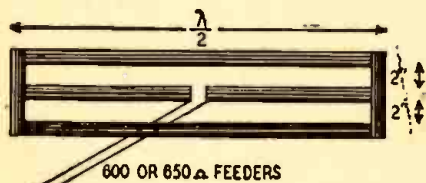

Fig. 7—A wide-band 3-element folded dipole.

feeders cannot react upon the radiator sections due to the grounded shield of the coaxial cable. In addition, the two feeder currents are balanced, one feeding the upper conductor and the other feeding the sleeve. As a result, there is practically no high-angle radiation from this antenna and it is an efficient type.

#### GROUND PLANE ANTENNA

High-angle radiation of power can also take place from the earth. This can be eliminated by cancelling out all downward radiation so that none can be

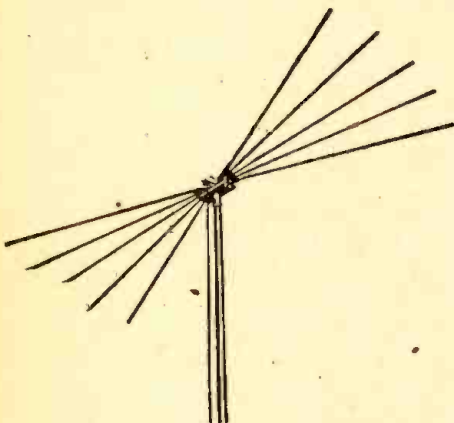

Fig. 8—A commercial type wide-band antenna.

reflected upwards. A ground plane right below the antenna can be introduced for this purpose. Fig. 6 shows such an antenna. Electrically, it is a quarter-wave vertical radiator mounted on an insulator and fed by the inner coaxial conductor. The outer conductor feeds the ground plane, which is made of either four or six spokes or radials which are mounted on a metal plate. Although these radials do not make a closed plane, the effect at the very high frequencies is practically the same.

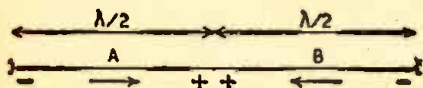

Fig. 9—Simple full-wave end-fire "array."

When designed properly, the radiation pattern is circular (or non-directional) in the horizontal plane, thus assuring a more efficient use of the radiated power. Downward radiation is prevented, and therefore no reflection upwards is present. This antenna is

# Thanks for your Patience!

**1001 BUYS**

**SURPLUS RADIO, INC.**

30 MUNSON ST. PORT WASHINGTON, N.Y.

TUBES  
RELAYS  
CHOKES  
RESISTORS  
RECEIVERS  
CAPACITORS  
TRANSMITTERS  
TRANSFORMERS

● We know you have been waiting patiently for your copy of the SURPLUS catalog. Now here it is, available to YOU!

Packed with the latest electronic components and equipment at prices a FRACTION OF THE ORIGINAL COST.

All equipment strictly BRAND NEW and UNCONDITIONALLY GUARANTEED.

Are you on our mailing list? Send a postcard for your FREE Copy!

**HERE'S AN EXAMPLE**

**UHF PRESELECTOR**

**For the UHF GANG!**

The Highest Gain Preselector Made! STOP DREAMING HERE IT IS! The most efficiently designed unit of its type which has ever been made available to the amateur. Complete with 3-GL446A tubes, spare parts, cables and sturdy wood carrying case. Original cost \$275. Your cost **39.50** All units Brand New.

FREQUENCY RANGE: 175 Mc. to 220 Mc. Easily adapted to cover the following bands: 224 Mc; 144 Mc; 54 Mc; 28 Mc.

**SURPLUS RADIO, INC.**

30 MUNSON ST., Dept. R-1  
PORT WASHINGTON, N. Y.

**FEATURES**

- Extremely high gain.
- Two grounded-grid lighthouse stages.
- Tuned cathode and plate circuits.
- R.F. circuits individually shielded with silver-plated brass.
- Disk type vernier trimmers.
- National velvet vernier dials.

## 500 FORMULAS TO SUCCESS

MANY million dollar firms started with a single formula, for which they paid a big price. Here you have 500—no less—tried and tested formulas, recipes and processes for making things . . . all at the ridiculously low price of 25c. Here is your opportunity to start a business with but a few dollars' capital and with undreamed of profits in prospect. You can also use these formulas in your own home to cut household expenses to the bone. Or you can put them to use in your workshop to cut costs as much as 1000%.

Quit paying out many dollars in profits to manufacturers, wholesalers, and dealers, when you can make the same thing yourself for a few cents. It's so easy when you follow our simple instructions.



66 PAGES, 3200 WORDS IN TEXT  
Send for "500 FORMULAS AND RECIPES" today. Enclose 25c, that's all! You won't be asked for another cent now or later. Sold on a money-back guarantee.

**NATIONAL PLANS COMPANY**  
P. O. BOX 26 R. STATION N. New York 23, N. Y.

easy to construct and install because it needs only one solid support, which may be combined with the coaxial feeder.

## GENERAL UTILITY CHEST

Radio Parts — Hardware — Tools, Etc.  
End opening—2 drawers 2" deep x 8 1/2" x 15 1/2"  
100 compartments. Every shop needs several of these well constructed plywood chests shipped express C.O.D. S/C cost \$27.50.  
Rush order today special price, \$5.45

**TERRY JAY**  
550 Arlington Place, Chicago 14, Illinois

### New Photo Electric Unit

For numerous control applications such as burglar alarms, industrial safety controls, automatic counters, or in conjunction with a chime or bell to announce entrance of person in stores and offices. For A.C. Complete with all tubes and built-in SPDT relay

\$11.95



**ADSON RADIO CO.**  
221 FULTON ST. NEW YORK 7, N. Y.

Most antenna systems tune sharply because of their basically high Q. In  
(Continued on following page)



# Presenting the New Improved JFD REMOTE-O CABLE REPLACER

Servicemen's  
Net Cost  
\$64.30

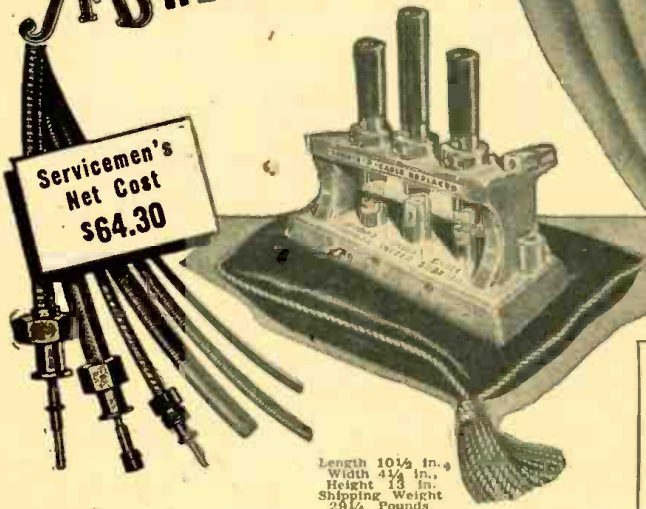

Length 10 1/2 in.  
Width 4 1/4 in.  
Height 13 in.  
Shipping Weight  
29 1/4 Pounds

DR. LEE  
DeFOREST  
We salute  
you on this  
40th Anniversary  
of  
The Vacuum Tube

## The Most Efficient Auto Radio Tuning Cable-Servicing Machine in Use Today!

1. SWEDGES SHAFTING TO PREVENT UNRAVELLING.
2. CUTS SHAFTING TO EXACT LENGTH.
3. REPLACES OLD FITTINGS ON NEW SHAFTING.
4. CASING GROOVE MAKES CUTTING EASY.

J. E. D. MANUFACTURING CO., 1111 FT. HAMILTON PKWAY, B'RYLN, N. Y.

## A LABORATORY QUALITY OSCILLOSCOPE For the Service Man . . .

Portable, sturdy, compact—the CRO-5A is an ideal unit for rapid, accurate, high quality service work. Check the utility and features which you have always wanted in the instrument on your bench.

- For better laboratory and production testing . . .
- For routine Service work . . .
- For studying any variable which may be translated into electrical potentials by means of associated apparatus . . .
- Designed with tubes for maximum amplification with minimum noise . . .
- Exceptionally stable trace even under adverse power line variations . . .
- Frequency response—essentially flat from 20 cycles to 350 KC . . .
- Completely self-contained . . .

Write to General Electric Company,  
Electronics Department SRC-6407,  
Syracuse 1, New York.



CRO-5A

**GENERAL ELECTRIC**

177-83

## ANTENNA PRINCIPLES

(Continued from page 123)

other words, their reactance is much greater than their resistance when they are tuned off their resonant frequency. This works out well if only one frequency is to be worked either with c.w. or with amplitude-modulated phone. For F.M. and television, the situation is changed and the technical requirements are much different. The antenna must be designed to have a more uniform response for reception or transmission of the wide-range signals.

The simplest wide-band antenna is one which is constructed of relatively large-diameter tubing. Electrically, this has the effect of reducing the Q. Still better results are obtained through the use of two or more conductors to form a single antenna system. A common antenna for this purpose is the folded dipole made of aluminum or copper tubing (Fig. 7). The figure shows three elements, but any number may be used. The distance between elements should be very small, a few inches at most, so that they are effectively in parallel at the frequency of operation.

Another great advantage of the folded dipole is the increase of impedance which is obtained at the point of feed.

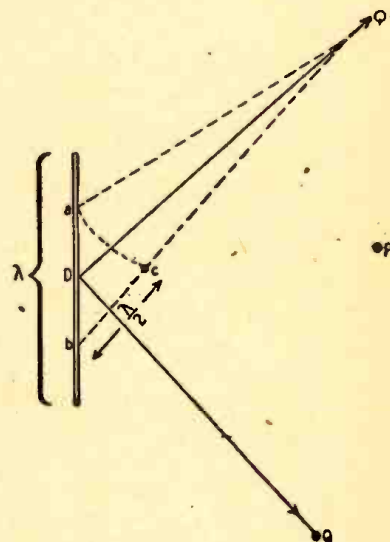

Fig. 10—Transmission from long-line antenna.

For two elements the impedance is 300 ohms and for three it is 650 ohms. These are values often used for transmission lines, therefore connection may be made directly to the antenna.

Commercial types of wide-band antenna systems are now beginning to appear on many roofs. Fig. 8 shows one type known as the "Di-fan"\*. It uses five elements extending in several directions and fed by one transmission line. It is designed to be effective over the television band or the FM band and gives a uniform response over a wide range of frequencies. The antenna elements are made of aluminum alloy and lie in a horizontal plane.

\* The Andrew Co.



### LONG-LINE ANTENNA

The multi-element types of antennas show that improvement can result by using more than one element. It is also possible to secure better directivity by using a longer single element than the basic dipole itself. However, the phase between elements must be considered.

Let two half-wave elements (Fig. 9) be connected directly to each other. If the free end of A is negative as marked, the other end of it must be positive at the same instant. Also, if the inner end of B is positive, its free end must be negative. Then electrons move from the two open ends towards the center of the long antenna. The fields radiated by such out-of-phase currents are equal and opposite. No signal can be received at right angles to such an antenna.

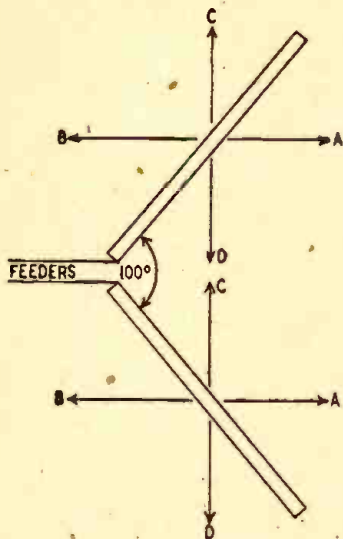

Fig. 11—The V—an approach to the rhombic.

See Fig. 10. P represents a station at right angles to the antenna and Q is another station making an angle with the full-wave antenna. As shown in the above discussion P will hear nothing because the fields from each half of the antenna are equal and opposite at this point. If Q is located at such a point that it is half a wavelength further from b than it is from a, this station will hear a loud signal from the transmitter. At a given instant, assume that a positive wave is radiated from a and a negative from b (since the currents at these points are out of phase). When the wave from b reaches point c (half a wavelength distant) a negative wave is being radiated from a. Note what happens. There are two negative waves moving at once towards station Q and they reach it at the very same time. Evidently, maximum radiation is in this direction and there is none towards P. It is found that the angle  $\theta$  is about  $50^\circ$ . The same reasoning shows that another station Q' will also receive a strong signal. Further, if the antenna is still longer, say two wavelengths, there will be four lobes, that is, four distinct directions of maximum radiation. In general, there is an added lobe for each half-wave. Note that the radiation in Fig. 10 takes place at an angle  $\theta$  all around the antenna. The actual solid three-dimensional pattern is made by  
(Continued on following page)



### CONGRATULATIONS DR. DE FOREST

without your pioneering work this amplifier would not have been possible.

**THE SECRET'S OUT!**  
The New and Spectacular  
**ACA-100DC AMPLIFIER**  
Is Ready For Delivery!

DESIGNED BY A. C. SHANEY

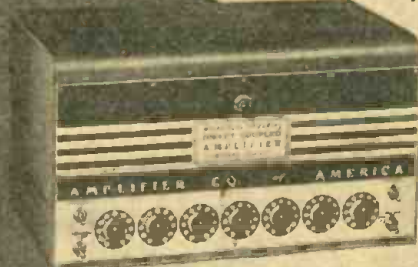

A revolutionary development in amplifiers cleverly designed to defy obsolescence and amazing in its performance. New circuits, new materials and new processes are actually combined in this one amplifier to produce the most satisfying musical amplifier the world has ever known. If you are one of those discriminating persons for whom nothing less than the best is a disappointment, you are one for whom the ACA-100DC was designed. Send for technical literature.

### AMPLIFIER CORP. of AMERICA

398 Broadway, New York 13, N. Y.

A. C. Shaney's FM-AM AMPLIFIER MANUAL is still available at 25c

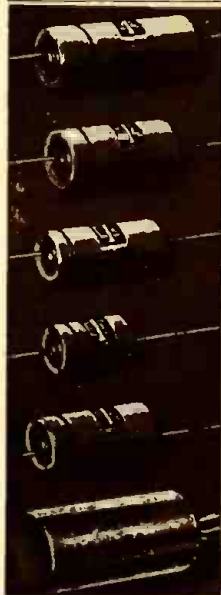

Now in full  
production on

**ELECTROLYTIC  
CAPACITORS**

to serve you better—faster

Our new plant has been specially designed for the manufacture of Electrolytic Capacitors. Newest production techniques, closer, more rigid control, air conditioning for better quality and employee working conditions and finest materials . . . all are features which insure you of the highest product standards. Illinois' Capacitors have been used by leading concerns of the nation for over 12 years. They have an unsurpassed reputation for lightweight, compact construction combined with ruggedness for long life.

Your copy of our latest catalog is ready for you. Write for it today.



### ILLINOIS CONDENSER CO.

1616 NORTH THROOP STREET • CHICAGO 22, ILL.

Supplying Every  
Electronic Need

- FOR THE—  
 RADIO SERVICE MAN  
 AMATEUR  
 STUDENT  
 EXPERIMENTER  
 INDUSTRIAL  
 WRITE FOR ILLUSTRATED PRICE LIST

**CRABREE'S**  
WHOLESALE RADIO

DALLAS 2608 ROSS AVE. TEXAS

Choose the **CANNON BALL**  
**HEADSET**  
You Like Best



Scientifically Built Heavy bar magnets greatly increase their efficiency.

Rugged construction. Inside or outside terminals. Sensitive, Clear tone. Dependable quality. Headset Headquarters guarantees satisfaction. Write for folder R-1.

**C. F. CANNON COMPANY**  
SPRINGWATER, N. Y.



# A Handy SALESKIT FOR RADIO SERVICEMEN

A real saleshelp exclusively for Radio Servicemen ... the Jensen Phonograph Needle Saleskit is just the thing for demonstrating fine needles. What's more, Jensen needles augment your work, assure full, clear tone of the instruments you repair, make all records sound better.

Colorful, convenient, compact ... the Saleskit slips easily into your pocket. Take it on service calls. It contains 3 Jensen Concert Needles retailing at \$1 each and 3 Jensen Genuine Sapphire Needles at \$2.50 each.

Available NOW at your jobber. WRITE TODAY for complete details and our better than usual discount to servicemen.

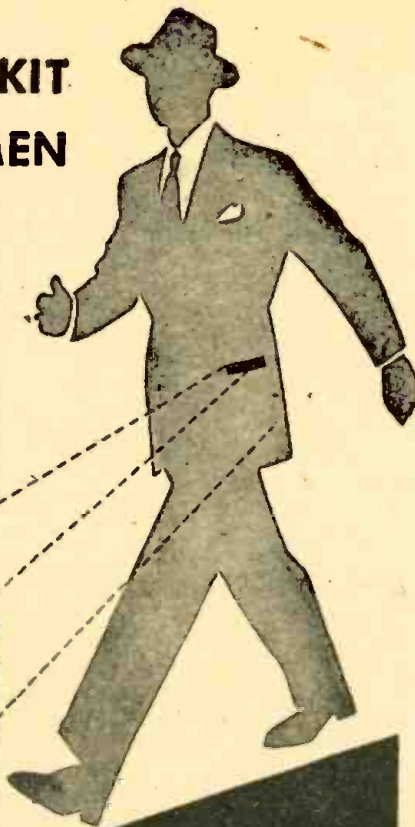

JENSEN INDUSTRIES, INC.  
327 SOUTH WOOD STREET  
CHICAGO 12 ILLINOIS

## ANTENNA PRINCIPLES

(Continued from page 125)

the lines DQ and DQ' swinging completely around the antenna.

The several lobes which are associated with long wires are generally disadvantageous. More often better efficiency results when only a single lobe is radiated or if the antenna is made non-directional altogether. Undesired lobe patterns may be eliminated in two ways: either they may be combined so that some are cancelled and others are strengthened; or the effects of the out-of-phase antenna currents may be eliminated.

### V AND RHOMBIC ANTENNA

The first method requires the use of two long-wire antennas which make up a V shape. While this type of antenna is not as popular among amateurs or listeners, it will be briefly described. Its chief disadvantage is the large area which is required. In addition, its construction is generally far beyond the abilities of the average operator.

Fig. 11 shows what happens when two full-wave conductors are joined to form a V. Radiation along the directions A and B is strengthened so that a strong signal will be heard by stations located along these lines. The radiation along C and D is cancelled.

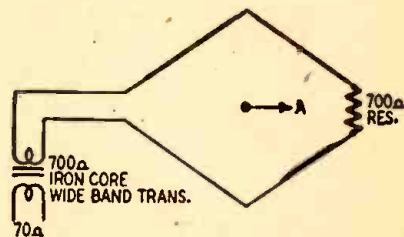

Fig. 12—The rhombic antenna is good at high frequencies where its size is not excessive.

A combination of two V antennas makes a rhombic antenna. The rhombic is also directional along A and B (Fig. 11). This antenna can be made unidirectional by closing its far end with a non-inductive resistor. When properly matched (about 700 ohms is required) the standing waves along the antenna are eliminated and communication can be carried on only in the direction A. The resistor must be capable of dissipating half of the power fed into the antenna. See Fig. 12.

### FM? NEVER HEARD OF IT!

FM is not as well known as many radiomen suppose, a survey completed last month by *American Magazine* indicates. Forty percent of the persons queried did not know the exact meaning of the term when asked about it. On the other hand, more than forty percent considered FM a necessity in their next radios. Sixteen percent did not consider FM essential and three percent did not answer.

## The Quality RADIO KIT

available at a Record Breaking Low Price

sensationally reduced below O.P.A. ceiling price

### MODEL S-5P



Improved superheterodyne circuit, built-in loop antenna, PM Alnico speaker, streamlined airplane dial, wide tuning range, 550Kc-1600 kc., 5 tubes (including rectifier 115V-AC-DC 12SK7 IF) 12SA7 converter, 12SQ7 Det. and 1st audio 50L6GT

output and 85Z5GT rectifier, brown bakelite cabinet.

Complete Kit less tubes \$10.95

Tubes available (prices on request)

Also Available Phono Kits Model RP-3 19.95

Radio Phono Kit Model RP-S5 34.95

Portable Radio Phono Kit Model RP-SSP 31.95

Portable Battery Kit Model PB-4 15.95

Record Changer Kit Model RC-3 39.95

(ALL KITS SUPPLIED LESS WIRE & SOLDER)

Write for Descriptive Catalog M

### RADIO KITS COMPANY

120 CEDAR STREET  
NEW YORK, N. Y.

## RADIO PARTS SOUND SYSTEMS ELECTRONIC APPARATUS

# Depend on RADOLEK

Radolek's big free Profit Guide Catalog and Profit Bulletin supplements keep you abreast of the rapidly changing radio situation. Buying from Radolek means greater values, better service and more profits. Make Radolek your buying headquarters.



RADIO PARTS



SOUND SYSTEMS

FREE CATALOG



Large Stocks  
Fast Service

SEND TODAY!

RADOLEK CO., Dept. C-113  
601 W. Randolph St., Chicago 6, Ill.  
Please send your FREE Profit Guide Catalog.

Name.....

Address.....

SAVE AT RADOLEK



**IT'S JUST ARRIVED!**

**A NEW BOOK EVERYONE SHOULD OWN  
ELECTRONICS  
FOR BEGINNERS**

By MERLE DUSTON

Here's a new non-technical manual on the theory, practice and how to build electronic devices. A practical, understandable, helpful book written by a recognized authority in this field.

**50¢**

ONLY PER COPY

For Sale by **RADIO-CRAFT** Dealers in Principal Cities Or Sent Postpaid on Receipt of 50 Cents in Stamps, Post Office Money Order or Check

**MERLE DUSTON & ASSOCIATES**

8907 KERCHEVAL AVE.  
DETROIT 14, MICHIGAN

**NOW IN STOCK!**



**The Famous SIMPSON model 260 VOLT-OHM-MILLIAMMETER** for Radio and Television Servicing (20,000 ohms per volt D.C.)  
AC-DC Volts: 0-5000  
DC Milliamperes: 10, 100, 500  
DC Microamperes: 100  
Decibels: -10 to +52 db.  
Ohms: 0-20 megohms  
Complete with test leads.  
NET PRICE—\$38.95

Also, SIMPSON model 215 (5000 ohms per volt) \$32.50  
SEND FOR FREE CATALOG!

Please Send 25% Deposit with C.O.D. Mail Orders.

**SCENIC RADIO** 53 Park Pl. Dept. F, New York 7, N.Y.

**PERMEABILITY TUNING**

For Broadcast Band Superhets. One compact tracked unit, including hookup diagrams and instructions.

Sample \$4.00 Postpaid (Standard discounts on re-order)

**SPECIAL OFFER**—1 Pair High Q 456 kc Iron Core I.F. TRANSFORMERS \$3.50

**MAGNA-METAL PRODUCTS**

70 E. 45 ST. NEW YORK 17, N. Y.

**RADIO SERVICEMEN: SPECIALS**

SELENIUM RECTIFIER—Replaces 11728, etc. \$0.99  
SAPPHIRE PHONO NEEDLE (10,000 Plays) . . . . .99  
DIAL CORD KIT—50 Ft. Ass'd & 3 Springs . . . . .99  
KNOB KIT—20 Ass'd Screw & Springs . . . . .99  
RESISTOR KIT—100 Ass'd 1/3 to 1 Watt . . . . .1.95  
BY PASS COND. KIT—35 Ass'd .005 to .1 . . . . .1.95  
SPEAKER GRILLE CLOTH—3 Ass'd 6" x 6" . . . . .49  
ANT. & OSCIL. or ANT. & RF. COIL SETS . . . . .89  
SPEAKERS—2 of 5" PM ALNICO 5 . . . . .1.99  
TUBE SHIELDS of FP. COND. MTC. PLATES . . . . .94  
RADIOS—5 TUBE SUPER '47 MODEL  
NATIONALLY KNOWN BRAND . . . . .NET 18.95  
Write Today for Satisf. Bulletin  
**RADIO DISTRIBUTING CO.,** Pasadena 18, Cal.

**NEW RADIO-CRAFT LIBRARY 50c BOOKS: JUST OUT! SEE PAGE 99.**

**THE CINEMATIC ANALYZER**

(Continued from page 117)

modulated more than 50 kc. In this case it is necessary to increase slightly the distance between the oscillating short-circuited turn and the oscillator winding. On the other hand, if the displacement is too great, so the 410- and 510-kc images are beyond the edge of the screen, the frequency-modulation swing is too small, and the turn must be brought nearer the winding. It is, of course, understood that the constructor has made absolutely certain that the local oscillator circuit is exactly on 877 kc.

As the image is moved from right to left on the screen by varying the frequency of the signal generator, its height should not diminish excessively at the two extremes. If there is such a diminution, the transformer tuned to 460 kc has not a large enough pass-band. The coupling between its two windings should be increased, and the two 20,000-ohm resistances across these windings reduced to about 10,000 ohms each.

The last step is to try the instrument as a panoramic receiver by attaching it to an antenna. Images of all transmissions less than 50 kc from the frequency to which the first section is tuned should be seen on the cathode-ray tube screen.

Our first article covered the principal applications of the cinematic analyzer clearly enough to render further explanations unnecessary. We limit ourselves to pointing out that the oscilloscope sweep should be sinusoidal for measurements in the r.f. and i.f. portions of the receiver, including the analysis of resonance curves. Sinusoidal sweep is also used for panoramic reception.

On the other hand, when cinematic analysis is used to investigate the audio end of a receiver, linear sweep is substituted, with the time base of the oscilloscope synchronized with the modulating frequency of the generator.

The use of flexible r.f. test leads and prods is extremely practical. Rapid analysis of a receiver is then effected by simply touching with the test prods the points from which it is desired to bring out a signal, or into which a frequency-modulated signal is to be injected from the analyzer itself.

We hope that the two articles which we have devoted to cinematic analysis will serve to spread this new method among American servicemen, and to aid them in working easier and faster. Further, we are quite certain, that once having mastered the new technique, they will make improvements that we, the technicians of the old continent, will be happy to adopt and possibly refine in our turn.

Let us add that the idea of the cinematic analyzer is due to our friend Robert Aschen, to whom our thanks are hereby tendered.



Leading the field in the production of quality sound equipment, Newcomb announces a new 30-watt phono amplifier. Its remarkable performance, its flexibility, make it the answer to the amplifier needs of the most critical. For wired music, as a monitoring or playback amplifier for broadcast or recording studio, or in the home as a deluxe phono amplifier, the KXP-30 is unequalled. Freedom from hum; dual-acting, distortion-free individual tone controls; extended flat frequency response from 20 to 20,000 cycles . . . these and other exclusive Newcomb features combine to make this the logical amplifier for the quality-minded buyer.

Not merely as good as the others, but better than all others.

Write for information.

**Newcomb AUDIO PRODUCTS CO.**  
MANUFACTURERS  
DEPT. C. 2815 S. HILL STREET  
LOS ANGELES 7, CALIFORNIA

**Taylor CUSTOM BUILT Tubes**

**TAYLOR TUBES, INC.**

2312-18 Wabansia Avenue  
CHICAGO 47, ILLINOIS

Manufacturers of  
**CUSTOM BUILT TRANSMITTING VACUUM TUBES**



# DEALERS

THERE'S A WORLD OF PROFIT  
IN HANDLING

## Talk-A-Phone

The World's Most Complete Line  
of Inter-Communication

Interested in bigger profits, easier sales,  
faster turnovers? Then look into what  
Talk-A-Phone has to offer. You never

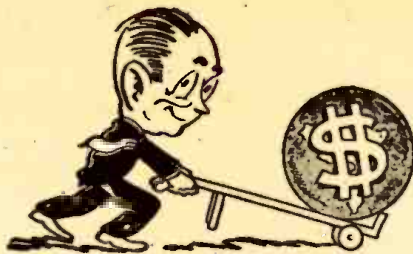

saw a better business-getting, profit-  
yielding proposition. Talk-A-Phone is  
tops in value—in the very latest inter-  
communication advancements. "Has  
Everything". Backed by National adver-  
tising. Out in front in demand.

### ASK YOUR JOBBER

Cut yourself in on a world of profit by handling  
the world's most complete line of inter-  
communication. Catalog listing a unit for every re-  
quirement upon request. Address Dept. A D

# Talk-A-Phone Co.

1512 S. Pulaski Road Chicago 23, Ill.

## TRANSATLANTIC NEWS

(Continued from page 90)

tubes. "Breaks" on the time base trace  
of a cathode-ray tube are all very  
well as indicators when instruments  
have to be mass-produced under war  
conditions. But the peace-time pilot and  
navigator want something neater and  
clearer than that. And they are getting  
it. Dials and pointers are taking the  
places of the time base trace and the  
"break." One system, the Decca, uses a  
hyperbolic lattice produced by a master  
station and "slaves" by means of un-  
modulated c.w. on very low frequencies  
in the neighborhood of 100 kilocycles.  
On one small panel the navigator sees  
two sets of numbers, which change con-  
tinuously, like those of a revolution  
counter. These show him from moment  
to moment the co-ordinates which give  
him his position on a special map. In  
the latest equipment another small  
panel contains a graduated dial with a  
pointer and three sets of easy-to-read  
figures. The pointer shows the exact  
deviation right or left from the proper  
track. One set of the figures indicates  
the miles at the moment between the  
aircraft and its destination; the second  
indicates the ground speed and the third  
shows the number of minutes early or  
late on scheduled time.

One disadvantage of simplifying the  
visible parts of almost any kind of  
electrical apparatus is that it can be  
done only at the expense of making  
the unseen works inside the cabinet  
more complicated—a fact not always  
appreciated by the user of a broadcast  
radio with its few controls. The simpli-  
fication of aircraft radar indicators is  
having the same effect and must lead  
to an increase in apparatus size and  
weight. That is probably well worth  
while if it means that pilot and naviga-  
tor obtain instant clear indications  
which require no working out. Nor will  
size or weight be of great importance  
if the present international commission  
can succeed in reducing the types of  
equipment that must be carried to rea-  
sonable numbers.

### TRIBUTE TO DE FOREST

There are few names in radio better  
known over here than that of Dr. Lee  
de Forest, "the man who put the grid  
into the radio tube." Humanity owes  
him a big debt, if it were only for the  
fact that his invention made possible  
the broadcasting services, which have  
done so much to brighten the lives of  
human beings all over the world. Those  
who were either unborn or still in their  
cradles in the days when broadcasting  
began cannot possibly realize the dif-  
ference that it has made to life, for to  
them it is unthinkable that news and  
entertainment should not have been al-  
ways available for the mere turning of  
a switch. The origin of every benefit  
that we have from radio today can be  
traced back to that fortunate moment  
when Lee de Forest was inspired with  
the idea of a control grid.

\$2.95



## TORNADO GAS TORCH

The Modern  
Way of Soldering

Ideal for hard and soft soldering. Will heat quickly; solder will flow freely  
and smoothly. No compressed air required. Nothing to pump. Self-adjust-  
ing. Safe. Economical. Can be used for annealing small parts and bending  
metal parts. Generates a heat of 1700° Fahrenheit. Simply connect to  
any illuminating gas jet with a rubber hose and operate. Tornado Torch  
No. 119 comes with three (3) tips, (1/8", 1/4", 3/8" blast.)

The Tornado Gas Torch No. 119, complete with three tips, is \$2.95. See  
your dealer or order direct. Send check or money order—postpaid.

ROBCO CORPORATION, DEPT. B, 202 E. 44TH STREET, NEW YORK 17, N. Y.

Come to the famous

## COYNE TRAINING SHOPS

where you learn by doing



## TRAIN FOR RADIO- ELECTRONICS IN A FEW WEEKS

Prepare For A Good Job Now With  
A Lifetime Future!

Trained Radio-Electronics men needed now. They  
will be needed too in the years to come. Don't be  
caught napping. Get a Radio training now and be  
ready. Learn by Doing, Free employment service  
for life after graduation. Many earn a while learning.  
If you are short of money, ask about my Student  
Finance Plan. Now added Training in Electric Re-  
frigeration. We are also equipped to train those who  
qualify under G. I. Bill. We also have facilities for  
men with physical disabilities whether due to war or  
other causes. Fill in and mail coupon for details.

SEND COUPON FOR FULL DETAILS

B. W. COOKE, Dir., Radio-Electronics Div.  
COYNE ELECTRICAL SCHOOL  
500 S. Paulina St., Dept. 17-8E, Chicago 12, Ill.  
Send Big Free Book; also details about Coyne Part-  
Time Employment and Student Finance Plan.  
 Send G. I. Bulletin  Physical Disability

NAME.....AGE.....  
ADDRESS.....  
CITY.....STATE.....



## BARGAIN SPECIAL

### 8000 OHM IMPEDENCE HEAD SET



Built on hearing aid princi-  
ple. Ear fitting rubber cush-  
ions attached to receivers  
shut out outside noise. Com-  
fortable, light metal band  
easily shapes to contour of  
head. 6-foot cord. Supplied  
complete as shown. Cost to  
make many times the price  
we ask. Every one brand  
new in original cartons.  
No. 17A420. **\$2.95**  
Special each

Order from this ad. Include postage.

### WRITE FOR CATALOG

Everything in Radio and Electronics in  
the new BA Catalog. Write if you are  
not already on our list.

## BURSTEIN-APPLEBEE CO.

1012 McGee, Kansas City 6, Mo.



The development of the radio tube from its primitive form to its modern make-up is not, of course, the work of one man only. Its original begetter was undoubtedly Thomas A. Edison who in his "Edison Effect" invented this one-way street for electrons long before its time. Sir Ambrose Fleming realized the possibilities of Edison's discovery for radio purposes and re-invented it long after as the Fleming diode, which could detect or rectify but nothing more. De Forest, by introducing the control grid, gave us a tube able not only to detect, but also to amplify and to oscillate. But for his invention radio telephony could never have made great advances. Later Hull and Round experimented in their own particular ways, and from their labors emerged a practical screen-grid tetrode. From that point progress led naturally to the pentode and the multi-grid tubes of today.

**TO THE FATHER OF RADIO**  
(Continued from page 57)

For many years, Dr. Lee de Forest was recognized as the inventor who laid the foundation of modern electrical communication, making possible all of its accomplishments.

But now it is clear that he really established the cornerstone for a new civilization which touches every phase of life. Without his vacuum tube, we would not have radar, guided missiles, the practical proceeds of nuclear fission, industrial electronic applications, and many other things to which must be added developments of the future as yet unforeseeable in their extent. This is a most fitting occasion to honor Lee de Forest.

—73—

**From Dr. A. Hoyt Taylor**

Chief consultant for electronics, Naval Research Laboratory; inventor of balanced ground-wire system, pioneer of radar development; author of numerous papers on radio subjects from 1902; ex-president, Institute of Radio Engineers.



Since I am completing a half century in radio this fall, I can almost be classed with the old-timers, although not with the real old-timers like de Forest, Marriott, and Dr. G. W. Pierce.

Like all the other old-timers I have great admiration for de Forest, the man and his work. He has always been a man of amazing ingenuity and versatility. Perhaps not everyone knows that he has a gift for pungent expression as well. At a meeting in Washington in 1928, I believe about the time I took over the

(Continued on following page)

**QUAM Adjust-a-Cone SPEAKERS**

Look for the 'U'-SHAPED COIL POT  
Mark of Quam Quality

**QUAM-NICHOLS COMPANY**  
Builders of Quality Speakers since 1923  
33rd PLACE AT COTTAGE GROVE • CHICAGO 16, ILLINOIS

**NEW PERMEABILITY VHF-FM TUNING UNIT**

Noted for its High "Q" and freedom from acoustical feed-back (howling) so common with condenser tuned circuits. Complete FM unit incorporates all parts including tube on a small metal frame. This is for mounting on a radio chassis where it will occupy 2" x 3" and extend 2" above and 2 1/4" below. It tunes 88-108 MC the new FM-100 commercial band. The shaft rotates 315°. Only four connections are needed to complete wiring. A special circuit provides an oscillator mixer with a sensitivity below 20 uv/m using a standard metal tube. Many FM-45 adapters or receivers can be changed with this unit to the new FM-100 band—or build your own FM receiver. The design has been worked out to eliminate erratic behavior so common in VHF when ordinary parts are used. It can also be adapted to other frequencies. Introductory price \$6.50 (less tube) postpaid.

Est. 1922 **J-M-P Mfg. Co.**  
ORDER TO-DA\* MILWAUKEE 10, WIS.

**THE YEAR'S BIGGEST OFFER**

**10 lb. Radio Parts Assortment**

A "find" for the radio serviceman. Hundreds of valuable radio parts, including coils, resistors, trimmer condensers, lugs, transformers, switches, hardware, etc.

Only ..... \$1.95

Write for radio parts circular

**RANDOLPH RADIO STORES**  
609 W. Randolph St. Chicago 6, Ill.

**Order from LAKE!**  
**You'll Make No Mistake!**  
**RADIO Cabinets & Parts**

**NOW Available!**  
Postwar  
2 Post  
**RECORD-CHANGER**

With luxurious brown leatherette portable case 15" L x 15" W x 10" D. Latest electronic developments make this modern record-changer the finest on the market today!

Changer—\$18.50 Cabinet for same—\$8.95

Also blank table cabinets of walnut veneer in the following sizes, with speaker opening on left front side. (Note: 7" has center speaker grill.)

#1 — 8 1/4" L x 5 1/2" H x 4" D	\$1.95
#2 — 10 1/4" L x 6 3/4" H x 5" D	\$2.75
#3 — 13 1/4" L x 7 5/8" H x 6 1/4" D	\$3.25
#7 — 10 3/4" L x 7" H x 5 1/2" D	\$2.50

\*Speaker Opening in center of front side.

All types of radio cabinets and parts are available at Lake's lower prices. A large stock is listed in our catalog.

**SERVICEMEN—RETAILERS**  
Join our customer list today.

Write today for our new 16-page illustrated catalog NR-116. It's free. Get on our mailing list.  
Dept. C

**LAKE RADIO SALES CO.**  
615 W. Randolph Street, Chicago 6, Ill.

**ELECTRICIANS GROW WITH YOUR INDUSTRY**

**ELECTRONICS is Your Next Step up in Position and Money**

Coyne's **ELECTRONICS** contains 400 concise, easy-to-read pages of practical information, for better pay—big jobs—in this advanced electrical field. Gives working knowledge . . . teaches you to select, install, maintain electronic apparatus. Expert electricians now in electronics say: "The most helpful, practical book on the market."

**"ELECTRONICS" PROVES ITS-SELF! 7 DAYS FREE TRIAL.**

"Electronics" is thorough, exact, simple, down-to-earth. Terms and principles clearly explained, into developments covered. Solid, practical facts are profusely illustrated with hundreds of valuable charts, diagrams, photos. See for yourself—try it for 7 days FREE.

**PARTIAL CONTENTS**  
Electronic Tubes  
Thyratron Control  
Automatic Timing  
The Ignitron  
Welding Controls  
High Frequencies  
Maintenance and  
Trouble Shooting  
. . . and hundreds of others.

Educational Book Publishing Division  
**COYNE ELECTRICAL SCHOOL**  
Dept. 17-TI, 500 S. Paulina St., Chicago 12, Illinois

**FILL OUT AND MAIL COUPON . . . NOW!**

Educational Book Publishing Division  
**COYNE ELECTRICAL SCHOOL**  
500 S. Paulina St., Dept. 17-TI  
Chicago 12, Illinois

Send me your new book **ELECTRONICS for RADIOMEN AND ELECTRICIANS** for 7 days free trial. If I am not 100% satisfied I'll return book and owe nothing. Otherwise, I'll send \$3.75—which includes one year of free technical bulletins.

NAME ..... AGE.....  
ADDRESS .....  
TOWN ..... ZONE ..... STATE.....  
OCCUPATION .....

( If you want the book sent C.O.D. check here )  
Same 7-day trial and money-back guarantee.



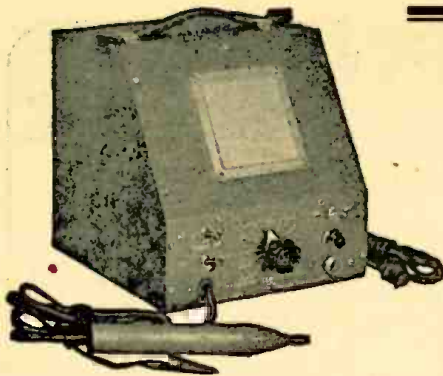

# NEW! faster, easier servicing by "listening in" with PRECISION ELECTRONICS SIGNAL TRACER

Real versatility! The "number one" instrument in any Service Man's equipment. Probe with Polystyrene tip (operates on frequencies up to 300MC), top quality parts throughout and exclusive engineering features. Outstanding "on-the-job" superiority!

**\$29<sup>95</sup>**  
**COMPLETE**  
**115 VOLTS**  
**50-60 CYCLES**

Checks signal stage by stage in R.F., I.F., and Audio sections. Speeds location of intermittents, opens, shorts, hums and noisy circuits with set hot or cold—coils condensers, transformers, resistors, speakers, tubes! See your Jobber or write for descriptive literature. (Please address Dept. C).

**PRECISION ELECTRONICS, Inc.**  
 641-643 MILWAUKEE AVENUE  
 CHICAGO, 22 ILLINOIS

## TO THE FATHER OF RADIO

(Continued from page 129)

presidency of the Institute of Radio Engineers—at any rate, at the same time that the Medal of Honor was presented to Dr. Pierce—Dr. de Forest sat across from me at the speakers' table at the dinner preceding the meeting. I shall never forget the speech that de Forest made on television in which he referred to early television as having been "born with only one pink eye through which it didn't see very clearly."

I haven't seen the Grand Old Man of American Radio for a good many years but I have had correspondence with him which shows that he is still green at the top and still full of ingenuity and new ideas.

—73—

### From Dr. Vladimir K. Zworykin

Research engineer, inventor and author; associate research director, RCA Laboratories; (previously director of electronic research, RCA); leading authority on television techniques; author of works on television and technical subjects, co-author of "Electron Optics and the Electron Microscope"; inventor of the Iconoscope, basic instrument of television transmission, and other television devices; member, Sigma Xi.



There is a notable gap between the discovery of the essential principles of television in the years from 1875 to 1884 and the witnessing of the first television picture. American, British, French, and German inventors struggled in vain against the apparently insuperable obstacle that the signal currents generated in their television pickup devices were too weak to control adequately the brightness of the light source in the receiver. De Forest's invention of the audion tube, in 1906, turned the dream of television into a reality.

More than that, the discovery of the ability of the audion to generate harmonic oscillations (1912) freed television from its dependence on wire or cable connection and ushered in television broadcasting on radio channels. In the words of the inventor himself:

"The fatal difficulty of insufficiently powerful reaction was overcome by a little three-electrode tube invented by the writer in 1906, and called by him the 'audion.' This revolutionary device, used as an amplifier, strengthened by astronomical ratios the ears of radio and the eyes of television, and made possible the clear reception over great distances, which we have today."

Apart from his other contributions to the art, the invention of the audion places Dr. de Forest in the forefront of television pioneers.

**150 DIAGRAMS and HOW TO READ THEM**  
**150 DIAGRAM BOOK FREE**  
 For Examining My New 7 Volume Set on

## ELECTRICITY

HERE'S a valuable book of 160 Electrical and Radio wiring diagrams with charts and instructions. Practical information you need to win security and promotion. It's yours FREE merely for examining my 7-Volume Set on Applied Practical Electricity on 7-day's free trial. This 7-Volume Set COVERS EVERYTHING ELECTRICAL from HOUSE WIRING to ADVANCED AC-DC MOTORS and EQUIPMENT. Thousands of diagrams and photos... written for both "beginners" and "old-timers" can easily understand.

**7-DAY'S FREE TRIAL** I want to send you the 7-volume set AT MY RISK, postpaid, for 7-day's FREE examination. I'll also send you the FREE book of 150 Shop Prints which you are to keep as my gift regardless of whether or not you return the 7-book set. (No salesman will call.) Offer Limited—Send Coupon Now!

Send No Money

**FREE COUPON** } NOT AN ORDER—JUST A REQUEST TO SEE BOOKS

S. W. Cooke, Dir., Coyne Electrical School, Dept. 17-72, 800 S. PAULINA STREET, CHICAGO 12, ILLINOIS

Send me the new 7-volume set "Practical Electricity." Also send the book of 150 Shop Prints which is a FREE gift to me regardless of whether or not I keep the 7-volume set. I'll return the 7-book set in 7 days and keep the 150 Shop Prints book as a gift from you and owe you nothing or pay \$3 within 7 days and \$2 a month until \$21 is paid, or I'll send the cash price of \$19.75. One year FREE Consultation Service and Technical Bulletins included.

NAME \_\_\_\_\_ Age \_\_\_\_\_  
 ADDRESS \_\_\_\_\_  
 TOWN \_\_\_\_\_ Zone \_\_\_\_\_ STATE \_\_\_\_\_

Check here if you want to save \$1.25 by paying the postman the cash price of \$19.75 on delivery. Same 7-day's examination and Money-Back Guarantee.

## HIGHBRIDGE'S BEST BUY! BRAND NEW ARMY MINE DETECTORS!

Portable: Will Detect METALLIC and NON-METALLIC objects; Very Sensitive; using 955 Tube in detecting head; two tube amplifier using two 1N5gt; headset; or microphone; also 150 micro meter; Power supply; 3-45v.; one 6-v.; or 2 3-v. batteries. Complete with instr. Less batteries; packed in original cases; shpg. wgt. 108 lbs.

FOB. From N.Y. Special **\$1750**

Send order to

**HIGHBRIDGE R. T. & A. SER. CO.**  
 340 CANAL ST., NEW YORK 13, N. Y.

**Guaranteed Factory Rebuilt Radio**  
**VIBRATORS - \$1.00 ea.**

6 Volt Non-Synchronous Vibrators \$1.00 ea.  
 6 Volt Synchronous, 12, 32, and 110 volt Vibrators \$1.25 ea.  
 Defective parts replaced.  
**48 HOUR SERVICE**

For the very prompt service enclose remittance and return postage. We rebuild any make or kind of radio vibrator. C.O.D. orders accepted. Send your sick vibrators to—

**BEST VIBRATOR CO., Box 5802-Z**  
 CLEVELAND 4, OHIO

**110 VOLT 60 CYCLE A-C MOTOR GENERATOR UNITS**  
 TWO BRAND NEW COMPLETE UNITS COST MARY \$97.50

Amazing value! You get two separate units. Will operate as two a-c motors or as an a-c generator. Precision built with ball bearings, polished aluminum housings. Operate small grinders, fans, polishing heads, etc. Students, schools can use to experiment with fascinating a-c phenomena. Generate a-c electricity, operate as rotary converter, synchronous motor-generator, use as phase shifter, variable transformer, etc. Free with each order—manual of interesting experiments and full instructions. Send money order, personal check, currency, or will send C.O.D. Order today or send card for more details.

**LEGO ENGINEERING CO., Box 908-RC-1, Lincoln, Nebr.**

**Only \$6.99** YOUR COST EXPRESS PAID

Fire alarm for hotels will use the regular hotel room radio, according to an American radio manufacturer.



## TELEVISION FOR TODAY

(Continued from page 82)

Phase distortion may be eliminated if the phase shift is zero or if a proportional amount of delay is introduced

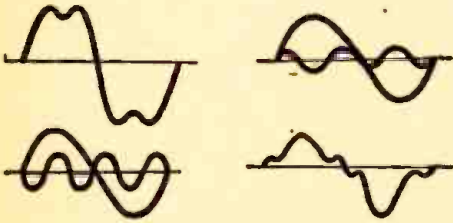

Fig. 6—How changing the phase of a distortive wave can affect the resultant waveform.

for each frequency. Thus, a phase delay of 30 degrees at 45 cycles is equivalent to 60 degrees at 90 cycles. The first produces a time delay of approximately

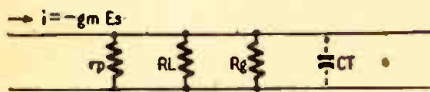

Fig. 7—Equivalent circuit, h.f. amplifier.

0.002 seconds, the same as 60 degrees at 90 cycles. The result is that all of the picture elements are shifted in equal amount. Correction may be achieved by positioning the picture.

### REFERENCES

Everest, F. A., *Wide-Band Television Amplifiers*, ELECTRONICS, Vol. 11, January, 1938.

McQuay, Jordan, *Video Amplifiers*, RADIO-CRAFT, June, 1946.

Kiver, M. S., *Television Simplified*, D. Van Nostrand Co., 1946.

Preisman, Albert, *Notes on Video Amplifier Design*, R.C.A. REVIEW, Vol. 2, April 1938.

Wheeler, H. A., *Wideband Amplifiers for Television*, PROC. I.R.E., July (1939).

Radio advertising by medical men will be initiated for the first time in the United States by the California Medical Association, which has voted to spend \$70,000 annually in radio to answer exponents of government health insurance plans.

## WAR SURPLUS

CENTRALAB—3000 VDC, 50 mmfd, type 850, silver Ceramic Condenser ..... 10 for \$1.39  
 SPRAGUE—Metal-encased, oil impregnated, tubular condensers, 600 VDC .1 mfd. 25 for ..... \$2.19 100 for ..... \$8.49  
 CRYSTALS—Sylvania type IN21, high frequency, plug-in receiving (makes a fine meter rectifier) ..... 2 for 98c  
 JACKS—Signal Corps type JK31A, short phone jack ..... 10 for 88c  
 MICAMOLDS—.01 mfd. 400 Volt, molded-in bakelite. 25 for ..... \$1.09 100 for ..... \$3.99  
 IRC RESISTORS—10,000 ohm, 10 Watt, type AB, cement coated. 25 for ..... \$2.19 100 for ..... \$8.49  
 Write for circular listing many other outstanding values. SPECIAL DISCOUNTS on quantities. Shipping extra.

**ERIE SUPPLY CO.**

88 Exchange St. Rochester, N. Y.

## SPEED UP REPAIRS WITH THESE G-C AIDS!



Two Popular New Additions to the Famous G-C Line!

### G-C De Luxe "SPEEDEX" Wire Stripper Kit

Handiest tool in the shop—the famous Speedex Wire Stripper complete with 7 interchangeable blades for stripping any size wire from No. 8 to No. 30. Put up in attractive permanent steel box. Available with Automatic or Regular Strippers.

No. 733-K Regular List Price \$15.00  
 No. 744-K Automatic List Price 17.00

Send For Latest G-C Catalog No. 147



### G-C PHONO TURNTABLE SERVICE STAND

This quickly adjustable phono service stand supports turntable at any convenient angle. Top or bottom mechanism can be worked on with ease. Definitely saves time and prevents damage to parts. Rugged—all steel—low cost. No. 5205 List Price \$6.65



**GENERAL CEMENT MFG. CO.**

ROCKFORD, ILLINOIS

## BRAND NEW! GUARANTEED

### Dykanol Capacitors

10 Mfd.—600 Volts DCW. .98c  
 .1 Mfd.—3000 Volts DCW. .69c  
 .1 Mfd.—7500 Volts DCW. 2.95



### Tube Bargains!

6AK5, Special ..... 1.50  
 6AC7 ..... 75c  
 2X2/879 ..... 95c  
 2051 ..... 1.25

### Midget Variables

Ceramic Insulation, top quality!

100 Mmfd. .... 88c  
 35 Mmfd. .... 69c



### Fixed Bleeder Resistors

50,000 ohms, 100 watts, IRC ..... 69c  
 10,000 ohms, 120 watts, Sprague ..... 39c



### Phone Plug & Jack Extension Cable

Standard phone plug and jack, 66 inch rubber covered kinkless cable. Ideal for head-phone extensions, speaker cable, patch cords, etc. 69c



WARRANTY—Every item we sell is fully guaranteed, regardless of its low price.

If unable to visit our store, send us your mail orders with 25% deposit. Remit in full all orders under \$5.00. Prices are F.O.B. New York.

**TERMINAL**  
*Radio Corporation*  
 85 CORTLANDT ST. N. Y. 7, N. Y.  
 WOrth 2-4415

## WIRELESS PHONO OSCILLATOR

NO LICENSE REQUIRED

Transmits recordings from phono pickup or voice from mike to radio without use of wires up to 500 ft. Neatly designed.  
 Complete kit, less tubes ..... \$3.49  
 Above kit assembled and tested ..... 4.49  
 Tubes for above kit (12SA7, 35Z5) ..... 2.49

IMMEDIATE DELIVERY

CONSTANT ELECTRIC, Dept. C

112 Cornelia Street Brooklyn 21, N. Y.

## THE STAR TESTER

MODEL M 11



All instruments shipped complete with batteries, test leads and instructions for use. Net Price

**26.95**

### FEATURING

A large 4 1/2" .400 microamperes meter for accuracy of readings on all ranges.

27 separate ranges for measurements.

1000 ohm per volt sensitivity AC and DC.

A metal crackle finish cabinet for ruggedness of use under all working conditions.

### DESIGN DATA

- 5 AC Voltage Ranges  
 0 to 10/50/250/500/1000 Volts
- 5 DC Voltage Ranges  
 0 to 10/50/250/1000 Volts
- 5 Output Meter Ranges  
 0 to 10/50/250/500/1000 Volts
- 4 DC Current Ranges  
 0 to 1/10/100/1000 MA
- 3 Resistance Ranges  
 0 to 5,000/500,000 ohms  
 0 to 5 Megohms
- 5 Decibel Ranges  
 -10 to +14, +4 to +28, +18 to +42,  
 +24 to +48, +30 to +54 DB

## STAR MEASUREMENTS CO.

442 E. 166th Street New York 56, N. Y.



## NEW RADIO!

TINYPOCKETSIZE  
 Slips in your pocket or purse! WT. ONLY 1/4 lb. Complete READY TO PLAY as shown with self contained phone for personal use. Beautiful black silver plastic case. Has patented fixed CRYSTAL-SLIDE TUNING DIAL. NO TUBES. BATTERIES OR ELECTRIC PLUG-IN REQUIRED. USUALLY RECEIVES LOCAL BROADCASTS without outside aerial wires.

GUARANTEED TO WORK when connected and used according to instructions. Can be used in homes, offices, hotels, cabins, in bed after hours, etc.

Send Only \$100 (cash, money order, check) and pay postman \$2.99 plus delivery fees on arrival or send \$3.99 for postpaid delivery. IDEAL GIFT FOR CHILDREN OR ADULTS ALIKE! Get your PA-KETTE RADIO NOW for real enjoyment. Foreign orders \$5.00 U.S. Cash.) Pa-Kette Electric Co., Dept. RC-1, Kearney, Nebraska



# 7 DAYS' FREE EXAMINATION



**\$4 COMPLETE** for **AUTO MECHANICS**

**PAY ONLY \$1 A MO.**

AUDELS AUTO GUIDE explains in detail with illustrations and diagrams for better service the whole subject of auto mechanics: Basic principles—Construction—Operation—Service—Repair. Handy Size, Easily understood. NEW FLUID DRIVE, HYDRAULIC SHIFT AND DIESEL ENGINES FULLY COVERED. Over 1700 pages—1540 illustrations showing inside views of modern cars, trucks and buses with instructions for service jobs. This standard book saves time, money and worry for operators and mechanics. Step up your own skill with the facts and figures of your trade. Audels Mechanics Guides contain Practical Inside Trade Information in a handy form. Fully illustrated and Easy to Understand. Highly Endorsed. Check the book you want for 7 days' Free Examination.

Send No Money. Nothing to pay postman.

## CUT HERE MAIL ORDER

AUDELS, Publishers, 49 W. 23 St., New York 10, N. Y.

Please send me postpaid for FREE EXAMINATION books marked (x) below. If I decide to keep them I agree to mail \$1 in 7 days on each book ordered and further mail \$1 monthly on each book until I have paid price. Otherwise, I will return them.

- AUTOMOBILE GUIDE, 1700 Pages \$4.
- REFRIGERATION & Air Conditioning, 1280 Pgs. 4.
- OIL BURNER GUIDE, 384 Pages 1.
- POWER PLANT ENGINEERS Guide, 1500 Pages 4.
- PUMPS, Hydraulics & Air Compressors, 1658 Pgs. 4.
- WELDERS GUIDE, 400 Pages 1.
- BLUE PRINT READING, 416 Pages 2.
- SHEET METAL WORKERS Handy Book, 388 Pgs. 1.
- SHEET METAL PATTERN LAYOUTS, 1100 Pgs. 4.
- AIRCRAFT WORKER, 240 Pages 1.
- MATHEMATICS & CALCULATIONS, 700 Pgs. 2.
- MACHINISTS Handy Book, 1600 Pages 4.
- MECHANICAL Dictionary, 968 Pages 4.
- DIESEL ENGINE MANUAL, 400 Pages 2.
- MARINE ENGINEERS Handy Book, 1280 Pages 4.
- SHIPFITTERS Handy Book, 272 Pages 1.
- MECHANICAL DRAWING COURSE, 160 Pages 1.
- MECHANICAL DRAWING & DESIGN, 480 Pgs. 2.
- MILLWRIGHTS & Mechanics Guide, 1200 Pgs. 4.
- CARPENTERS & Builders Guides (4 vols.) 6.
- PLUMBERS & Steamfitters Guides (4 vols.) 6.
- MASONS & Builders Guides (4 vols.) 6.
- MASTER PAINTER & DECORATOR, 320 Pgs. 2.
- GARDENERS & GROWERS GUIDES (4 vols.) 6.
- ENGINEERS and Mechanics Guides
  - Nos. 1, 2, 3, 4, 5, 6, 7 and 8 complete . . . 12.
- Answers on Practical ENGINEERING . . . 1.
- ENGINEERS & FIREMANS EXAMINATIONS . . . 1.
- ELECTRICIANS EXAMINATIONS, 250 Pages . . . 1.
- WIRING DIAGRAMS, 210 Pages . . . 1.
- ELECTRICAL DICTIONARY, 9000 Terms . . . 2.
- ELECTRICAL POWER CALCULATIONS, 425 Pgs. . . 2.
- HANDBOOK OF ELECTRICITY, 1340 Pages . . . 4.
- RADIONOMAS GUIDE, 914 Pages . . . 4.
- ELECTRONIC DEVICES, 216 Pages . . . 2.
- ELECTRIC LIBRARY, 12 vol., 7000 Pgs., \$1.50 vol.

Name \_\_\_\_\_

Address \_\_\_\_\_

Occupation \_\_\_\_\_

Employed by \_\_\_\_\_ R.C.F.

## SOUND ENGINEERING

(Continued from page 89)

like to know if this scratch can be eliminated, or is the amplifier too old to be used with the new high-impedance pick-up on my present changer unit.

DERBIN S. BLOSSER,  
Mechanicsburg, Penn.

### The Answer . . .

The easiest, but not the best way, of eliminating or reducing scratch in your particular amplifier would probably be to shunt some of the high frequencies out of the circuit by bypassing some high-impedance grid circuit with a suitable condenser and series variable resistor. The fallacy of cutting high frequencies in an attempt to suppress scratch is, of course, obvious. When the upper audio spectrum is affected, it alters the higher harmonics of any tone. Some so-called scratch filters eliminate, or greatly attenuate, all frequencies above 3,000 cycles. While it is true that the ear may be conditioned to such reproduction, unconditioned listeners would immediately notice the limited range of the system. To really eliminate scratch, some kind of circuit must be utilized which will differentiate scratch from music. Such circuits have been commercially developed, but they cannot be incorporated into any amplifier.

I therefore suggest that you either select records which have minimum scratch, or try a variety of phono needles, or sacrifice some of the high frequencies by using a standard "tone control" to eliminate the disturbing characteristics of scratch. If you are interested in the theoretical aspects of scratch filter design, you might refer to an article by that name in RADIO-CRAFT, February, 1940, page 472.

## a GOLD MINE of SURPLUS PARTS for RADIO REPAIRMEN AMATEURS AND EXPERIMENTERS

**12 lbs. of RADIO PARTS only \$2.00**

Relays — Condensers — Resistors  
Transformers — Coils — Hardware  
Wire, etc., etc.

Send 2.00 cash, M.O., or check today! (Pay small express charges on receipt.) Write for Radio Parts Catalog.

**ELECTRONIC PARTS, Inc.**  
622 W. Randolph St. Dept. CI Chicago 6, Ill.

## Make Hundreds of Fascinating RADIO ELECTRICAL EXPERIMENTS Only \$4.99 POST PAID U.S.A.

50-Piece Genuine New War Surplus Electronic Apparatus. Super-bargain — worth \$25. Includes headphone, capacitors, potentiometers, resistors, fuses, sockets, wire switches, etc. Build hundreds fascinating circuits. Learn electronics. 50-piece kit with complete instructions, and plans for home laboratory.

Send only \$4.99 today, or will ship C.O.D.  
LECO ENGINEERING CO., Box 931-C4, Lincoln, Nebr.

## LEOTONE SERVICE-MEN'S SPECIALS

TUBES: Perfect condition, but not in sealed cartons. Guaranteed 90 days. #27, 40, 50 or 6B, 29; #24, 42, 77, 89, 6A7, 6D8, 6K6, 6K7. . . . .39

Brand new R.C.A. UX-200 tubes in sealed cartons (detector & amplifier) . . . . .1.00

RADIONOMAS HARDWARE TUBES: Over 1000 ass'd. screws, nuts, washers, lugs, etc. PLUS handy 36 compartment cardboard kit box . . . . .59

Victor Power Transformer . . . . .59

45, 52 or 75. Unshielded . . . . .5.95

### BARGAIN ASSORTMENT KITS

- #1 R.F. Antenna & Osc. coils, 10 ass'd. . . . .98
- #2 Speaker Cones; 12 ass'd. 4" to 12" moulded & free-edge (magnetic incl.). Less voice coils . . . . .2.00
- #3 BAKELITE MICA CONDENSERS: 50 ass'd. .00005 to 20mfd. 200-600WV. Clearly marked . . . . .2.95
- #4 Tubular By-Pass Condensers: 50 ass'd. .0005 to 25mfd. 200-600WV. Standard units . . . . .2.49
- #5 Electrolytics: 10 ass'd. including multi-section, paper & can types . . . . .1.25
- #6 Dial Scales: 25 ass'd. Airplane & slide-rule (incl. 10 glass) . . . . .2.98
- #7 Escutcheon Plates: 25 airplane, slide-rule and full vision types . . . . .2.95
- #8 Knobs: 25 ass'd. wood & bakelite, including setscrew & push-on types . . . . .1.00
- #9 Washer Sockets: 12 ass'd. 4 to 7 prong . . . . .26
- #10 Voltage Dividers: 10 ass'd. standard multi-tapped. High wattages included . . . . .1.98
- #11 Shield Cans: 15 ass'd. for coils, tubes, transformers, etc. . . . .1.00
- #12 Mica Formers & Spacers: 15 ass'd. incl. multiple & ceramic base types . . . . .69
- #14 Potentiometers & Controls: 10 ass'd. wire-wound & comp. Less switches . . . . .1.49

20 EXPERIMENTAL TUBES, all filament tested; incl. most sizes & base types . . . . . **1.00!**

## SURPLUS BARGAINS

- SELSYN MOTORS (#2J1F3) Used in pairs as transmitter & follower on 45V. 50 cycles. 2 1/2"x4". Per pair (shpg. wt. 3 lbs.) . . . . .3.95
- Shunt Wound Reversible Motor: 1/40 H. P. duty. 3"x4 1/2". Black crackle finish. Shaft 7/8" Long . . . . .3.45
- Gen'l Electric 27V. DC. 148 RPM. .65 amp. 2 1/2"x4". Forc. air. insul. alum. shell. 25 watt-g. 15, 25, 50, 100, 375 or 500 ohms . . . . .1.49
- EARPHONE HEADBANDS (Army HS-33) Leather covered frame, ad. forks. With PL-54 plug and 16 double phone cord . . . . .39
- PL-54 plug 1 1/2" tipped double phone cord . . . . .19
- JK-26 ext. jack (for PL-54). Bakelite shell . . . . .25
- 4 TUBE AMPLIFIER (2-7C5, 7F7, 7Y4) Used as electronic supercharger control. 110V. 400 cycle. Contains: power trans., condensers mica and oil). 7 resistors, 4 local sockets plus other components worth many times the price. Black crackle finish. Sited slide-in chassis. 8 3/4"x4 1/2"x3 3/4". Less tubes. . . . .1.49
- POWER RHEOSTATS, all with knobs and mg. controls. Forc. air. insul. alum. shell. 25 watt-g. 15, 25, 50, 100, 375 or 500 ohms . . . . .69
- 50 watt-15, 50, 100 or 500 ohms . . . . .98
- Ohmite 25 ohm-50 watt. ad. slide tnp. 4" L. 120 ohm-25 watt wire-wound. ad. resistor . . . . .28
- SHUNTS-MULTIPLIERS, 1% precision, wire-wound. Ohmage: 2.35, 5.20, 11, 24.3, 90, 408, 840, 1740, 2500, 3400, 5400, 7800, 30K or 40K ca. . . . .35
- Weston 1% Precision resistors on ceramic form. Ohmage: 135K, 104.5K, 22.8K, 450K, 500K, 800K or 3 megohms. 12 for 1.50
- Frequency Meter Tech. Manual (Navy) Theory and Operation. 39 illust. and diagrams: 58 pp. . . . .15
- 110V. PANEL LIGHT ASSEMBLY. 1" amber jewel. D.C. base. Gun metal finish; O.D. 1" . . . . .49
- Neon Glow Lamps (fits above ass'y): 110V. 3/4 watt. clear bulb. Double cont. base. base CHALE CONNECTORS. Chrome metal (for cable up to 3/4" O.D.); chassis mg. female . . . . .35
- O.D. Ideal size for radio and P.A. work. Set 2" Meter Case and Housing (round). Complete with glass and adjust screw. 1" deep. . . . .39
- Weston #301 meter glass and frame. 3" O.D. . . . .89

## ALNICO MAGNETS

- #1 Bar. 8 1/2"x1/4"x1/4" . . . . .39
- #2 Bar in shorter lengths; rear inch. . . . .12
- #3 Face 1 1/2"x3/4"x1/2" high . . . . .98
- #4 Heavy duty bar. 1 1/2"x1 3/4"x1/10" thick. . . . .98
- #5 Face 3/4"x3/8"x3/8" high . . . . .39
- #6 Polished bar. 9/16"x9/16"x3/8" high . . . . .20 for 1.00
- #7 Face 1 1/2"x1/2"x3/8" high . . . . .10
- #8 ALNICO V. horseshoe. poles 3/8" sq.; 1 1/2" high . . . . .75
- #9 ALNICO V. horseshoe. 9/16" poles sq.; 1 1/2" high . . . . .98

16" N.B.C. RECORDINGS. Each contains 2 complete 15 min. "Voice of the Army" dramatic programs with music. Over 60 different titles such as: Time Runs Out, Day For History, On The Beam, etc. 33 1/3 RPM 5 ASS'D. RECORDS (16 DIFFERENT PROGRAMS)

**1.49**

Prompt Service on All Speaker and Phono Pickup Repairs  
Minimum Order \$2.00—20% Deposit  
Required on all orders  
WRITE DEPT. RC-1  
Please Add Sufficient Postage

**LEOTONE RADIO CO.**  
MAKERS OF CONES AND FIELD COILS  
65-67 DEY STREET, NEW YORK 7, N.Y.  
WORTH 2-0284-5  
12,000 SQ. FT. OF RADIO PARTS



# HELLO! CHECK THESE "GET ACQUAINTED" VALUES!

## • SPEAKERS

**5" P.M. 1 oz. ALNICO 5 MAGNET \$1.39**

6 for \$8.00

6" PM 1 oz. Alnico 5 Magnet ..... \$1.98  
 6" PM 2.15 oz. Alnico 5 Magnet ..... 2.79  
 8" PM 20 oz Slug \$4.95 12" PM20 oz Slug ..... 8.95

## VOLUME CONTROLS

**1/2 MEG with switch and 2" shaft 75c**

6 for \$4.25

Kit of 10 assorted controls, without switch ..... \$1.95

## WIRE

Approximately **400** ft. of Wire in assorted colors and gauges, solid and stranded in 2 to 4 foot lengths, per pkg. ..... **\$ .99**

2 pkgs. for \$1.90

No. 20 shielded wire, stranded, per ft. .... \$ .03  
 2 conductor mike cable, per ft. .... .06  
 Radio grade spaghetti, 1c ft., No. 20 solid push-back ..... 1c ft.

## CABINETS

**PORTABLE PHONOGRAPH CASE two-toned Leatherette finish, Dimensions 15 1/2" L x 14 1/4" W x 8" H \$9.95**

Portable Automatic Phonograph Record-Changer Case ..... **\$14.95**

## TRANSFORMERS

**70 MIL POWER TRANSFORMER 600 V. 6.3V @ 3 Amp. C.T., 5V @ 3 Amp. \$2.95**

3 for \$8.00

50 Mil Power 500V, 6.3V @ 2 Amp. 5V @ 2 Amp \$1.95  
 90 Mil Power 500V, 6.3V @ 3.5Amp. 5V @ 3 Amp. 3.25  
 120 Mil Power 500V, 6.3V @ 5 Amp. 5V @ 4 Amp. .... 4.25  
 50L6 Output ..... .59  
 6V6 Output ..... .69  
 8 Watt Universal Output ..... 1.29

2 Post V.M. Record Changer \$17.95  
 3 for \$52.00

## CONDENSERS

**TUBULAR PAPER CONDENSERS All 600 Volt test**

MFD.	PRICE EACH	100	MFD.	PRICE EACH	100
.01	.08	\$6.50	.001	.08	\$6.50
.02	.08	6.50	.002	.08	6.50
.05	.10	8.00	.005	.08	6.50
.1	.12	9.00	.006	.08	6.50
.25	.17	13.50	.5	.26	22.50

## "ILLINOIS" ELECTROLYTICS

MFD.	VDC.	PRICE	MFD.	VDC.	PRICE
10	25v	.25	50	150v	.50
100	25v	.55	8	450v	.38
12	50v	.38	10	450v	.43
16	150v	.35	16	450v	.55
20	150v	.38	20	450v	.60
24	150v	.38	40	450v	.88
30	150v	.40	100	15v	.49

## DUALS

16-18	150v	.58	50-30	150v	.70
20-20	150v	.65	8-8	450v	.65
30-30	150v	.70	10-10	450v	.70
40-20	150v	.70	20-20-20	150v	.99

Mica Condensers. All sizes 8c each  
 10% discount on all electrolytics if purchased in lots of 20 or more

## RESISTORS

1/4 watt, all sizes	.....2c
1/2 watt, all sizes	.....3c
1 watt, all sizes	.....4c
5 watt wire-wound	.....18c
10 watt wire-wound	.....20c
25 watt wire-wound	.....30c

Resistor kit containing 100 insulated resistors in popular sizes of 1/3, 1/2, 1 and 2 watt. .... \$1.95

All items subject to prior sale

20% with order, balance C.O.D. We prepay express on \$50.00 orders in U.S.A.

**ELECTRONIC PARTS, Inc., Dept. C1**  
 622 W. Randolph St. Chicago 6, Ill.

RADIO-CRAFT for JANUARY, 1947

## MEDIUM POWER TRANSMITTER

(Continued from page 67)

same material. The front panel and the top are Masonite measuring 3 x 14 1/2 and 7 x 14 1/2 respectively. Small brads are used to fasten the top and front to the side members. If a metal chassis is preferred, a standard 8 x 17 x 2 inch plated or crackle-finished chassis may be used.

Socket holes are drilled for the tubes, coils and crystal. The location of the surface-mounted components is shown on Photo A. A five-prong socket is used with the older type of crystal holders. The newer type holders will fit into an octal socket. Holes are drilled in the front wall of the chassis for pilot lamp, tuning condensers and current-metering jacks. A jack, mounted on the rear wall near the 6L6 socket, serves both as a jack for metering the oscillator current and for keying the oscillator. A centrally-located five-prong socket is used for the input leads for the filament and oscillator voltages and common ground connection. The positive high-voltage lead for the power amplifier may be connected at this socket if the voltage does not exceed 600 volts. A separate feed-through should be used to prevent insulation breakdown and short circuits if higher voltages are used. Two color-coded binding posts, red and black, are mounted to provide connections for an external bias supply.

The oscillator plate voltage is supplied from a power supply capable of delivering 350 to 400 volts at 100 ma. This voltage is dropped to the correct value for the screen grid by bleeder resistors connected across the high-voltage supply.

Capacity coupling is used between the oscillator and the plate-neutralized amplifier. Series feed is used in the plate circuits of both stages. (If a metal chassis is used, the condensers should be carefully insulated from the chassis and ground. Insulated shaft couplings and well insulated knobs should be employed on the tuning and neutralizing condensers to prevent the operator from receiving a severe shock or possible injury.) The neutralizing condenser, CN, mounted above the chassis on a ceramic stand-off insulator, is located close to

## RADIO TERM ILLUSTRATED



Suggested by:  
 Joe W. Baker,  
 Olic, Montana

"Transmission Loss"



**FEDERATED GETS YOU STARTED**  
 for as little as **\$195.00**

For Servicemen starting a radio repair business—Federated has a plan to smooth the way! Backed by our huge stocks of radio and electronic components, and our many years of experience in filling the needs of the radio serviceman, we can help YOU, because

**WE KNOW WHAT YOU NEED**

A special department in our organization, staffed with special personnel qualified by long actual experience in radio service work, will help you get started. Test equipment, tubes, replacement parts, tools, manuals, EVERYTHING you will need, to set you up in a profitable radio repair business, all included in our plan! For interesting details:

WRITE DEPARTMENT 27-C.

**Federated Purchaser**  
 INCORPORATED  
 Distributor of RADIO-ELECTRONIC and SOUND EQUIPMENT  
 80 PARK PLACE, N. Y. 7  
 Phone: WH 4-2880

**ACT QUICKLY—**

**LIMITED QUANTITY!**

## F.M. and Television Signal Generator

Converted Western Electric SIGNAL GENERATOR for F.M. and TELEVISION, 54-106 Mc. Individually calibrated. Well constructed, will maintain calibration. Brand new Duco finish. Inquire about additional frequency ranges.



WHILE THEY LAST..... **\$34.50**

ALUMINUM CASES for SCOPES, MOBILE RIGS, POWER SUPPLIES and many other uses. With punched front panels and chassis. Size 12 x 14 x 21 inches. Well ventilated. With 2 handles. Brand new Duco finish.

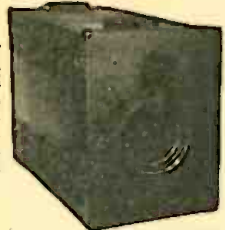

ONLY..... **\$7.50**

Heavy duty shock-mount base assembly for above cases, only \$1.50.

A 14-prong cathode ray tube Socket assembly with provision for angular adjustment of tube, also has springs to maintain position with front panel. Only \$1.95.

All above is war surplus in good condition.

All prices F.O.B. this address.

Full remittance with all orders.

Last three items all for \$9.95.

IMMEDIATE DELIVERY

**ALGERADIO ELECTRONICS CO.**

Dept C 147 278 E. Columbia St., HEMPSTEAD, N. Y.



# MIDWEST RADIOS

at Greater-Than-Ever VALUES

**BIG, POWERFUL WORLD-RANGING CHASSIS with FM (Frequency Modulation) 5 WAVE BANDS**

SEPARATE CHASSIS or COMPLETE CONSOLES AVAILABLE

EASY TERMS

**30 DAYS TRIAL**

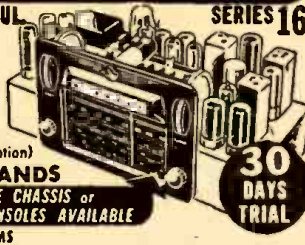

## The SYMPHONY GRAND AM-FM RADIO-PHONOGRAPH

A magnificent radio console and musical instrument that is completely new—from the ground up. Big, powerful Series 16 Chassis brings in long wave, short wave, and advanced FM reception. Automatic record-changing phonograph and scores of NEW post-war features including:

**TRI-MAGNADYNE COIL SYSTEM**—a sensational, exclusive MIDWEST feature fully described in our new 1947 catalog. Also, other console and table models with Series 16, 17, and 8 Chassis, and portable AC/DC Battery Table Radios.

SEND FOR **FREE CATALOG**

**BUY DIRECT FROM FACTORY and SAVE!**

FILL IN COUPON AND SEND YOUR NAME AND ADDRESS ON 14 POSTCARD

MIDWEST RADIO CORPORATION  
Dept. 38-B, 909 Broadway, Cincinnati 2, Ohio.

Please send me your new FREE Catalog.

Name .....

Street .....

City ..... Zone ..... State .....

## RADIO PARTS ASSORTMENT

Hundreds of valuable and useful radio parts. Transformers, terminals, coils, condensers, oscilchoons, wire, etc., etc.



All brand new war surplus.

**10 lbs. \$1.69**

## U.S. SIGNAL CORPS 2-WAY TALKING SYSTEM

Made by Western-Electric for army tanks. Now you can use them for offices, garages, farms, baby's room to kitchen, etc. Just plug into AC, consists of one master unit and 1 speaker-receiver unit.

- Complete—ready to operate. .... **\$34.50**
- BC-312, 342 I.F. crystal transformer, resonant at 470 KC. Replace that 1st. I.F. with this unit and separate those crowded ham bands. .... **\$6.49**
- Double button mike to grid trans. made for Western-Electric. .... **\$.59**
- Kit of 10 asst. RF coils—a real buy ..... **\$1.98**
- Power trans., 350-0-350, 60 mils, 6.3V. @2A, 5V. @2A. Flush mounting. .... **\$2.15**
- HS-30 Hearing aid type headphone with plug and matching trans. closeout ..... **\$1.98**
- HS-16 Noise proof headset. .... **\$2.98**
- A superior headset. .... **\$15.00**
- Broadcast band converter for BC-312, 342, NC-100, BC-348, state model receiver ..... **\$15.00**
- Interlock switch for doors, protection against hi-voltage. .... **\$1.89**

REMIT 25% WITH ALL C.O.D. ORDERS

**THOR ELECTRONICS**  
5051 N. CLARK ST., CHICAGO, ILL.

## MEDIUM POWER TRANSMITTER

(Continued from page 133)

the amplifier grid pin. This condenser is made by removing plates from a small Cardwell Trim-Air condenser so that one rotor and one stator plate remain. Double spacing is used between these plates. A commercial neutralizing condenser may be used if its minimum capacity is 1.5  $\mu\text{f}$ , or less, with sufficient spacing to withstand a voltage equal to the sum of the plate and grid bias voltages.

A 100- $\mu\text{f}$  receiving type condenser is used to tune the oscillator plate tank circuit. The amplifier plate tuning condenser shown in Photo B has a split stator with 75  $\mu\text{f}$  per section. The sections may be connected in parallel for 80-meter operation but this value is too large for efficient operation on the higher frequencies. A single-section 75- $\mu\text{f}$  condenser will work effectively on the three lower-frequency amateur bands. The breakdown voltage rating should be equal to at least twice the plate voltage.

Power for the transmitter may be obtained from any supply capable of delivering between 500 and 1500 volts with a 150- to 200-milliampere load. The filaments are supplied by a transformer delivering 6.3 volts at 4 amperes or more. If the transformer has a five or six-ampere rating, this will help to stabilize the filament voltage against drops in line voltage and on long filament leads. If the supply is in the order of 600 volts, a dropping resistor may be used to drop the voltage to 350 or 400 volts for the oscillator.

At this installation, we had a power supply that delivered 650 volts at 200 ma from the filter with choke input and 850 volts with condenser input. The lower voltage is used while making tuning adjustments. The input choke is shorted with a switch for normal operation. When the high-voltage supply exceeds 600 volts, it is advisable to use a separate supply for the oscillator.

## TUNING ADJUSTMENTS

Initial tests should be made on 80 meters since the broader tuning on this band makes adjustments easier. The power supplies are connected to the transmitter and coils and crystal for the 80-meter band plugged into the proper sockets. A 150- to 200-ma meter is plugged into the jack in the cathode circuit of the 6L6. The plate voltage is applied to the oscillator ONLY. The tuning condenser is rotated slowly and adjusted for minimum current on the meter. If the stage does not oscillate readily or follow rapid keying, its plate circuit should be detuned slightly to the minimum capacity side of the cathode current dip. The meter is removed and placed in the grid circuit jack of the amplifier and a key inserted in the oscillator jack. With the key closed and no plate voltage on the amplifier, the tuning condenser of the latter is rotated through its range. At resonance, a dip in grid current will be noted, indicating that the amplifier is not neutralized. The neutralizing condenser is adjusted in small steps until the plate condenser can be rotated throughout its range without causing the grid current to fluctuate. With the neutralizing condenser set at this point, the amplifier is neutralized. If no meter is available, a flashlight bulb soldered to a loop of wire slightly larger than the diameter of the coils, and fastened to a dowel, may be used as a neutralizing indicator. This coil is coupled closely to the amplifier plate coil and the neutralizing condenser adjusted to the point where the lamp does not glow at any setting of the amplifier tank condenser.

With the amplifier neutralized, the meter is moved to the amplifier plate jack and voltage applied. When the key is depressed, the amplifier plate current will rise to a high value when the plate circuit is out of resonance. While keying intermittently, the amplifier tank

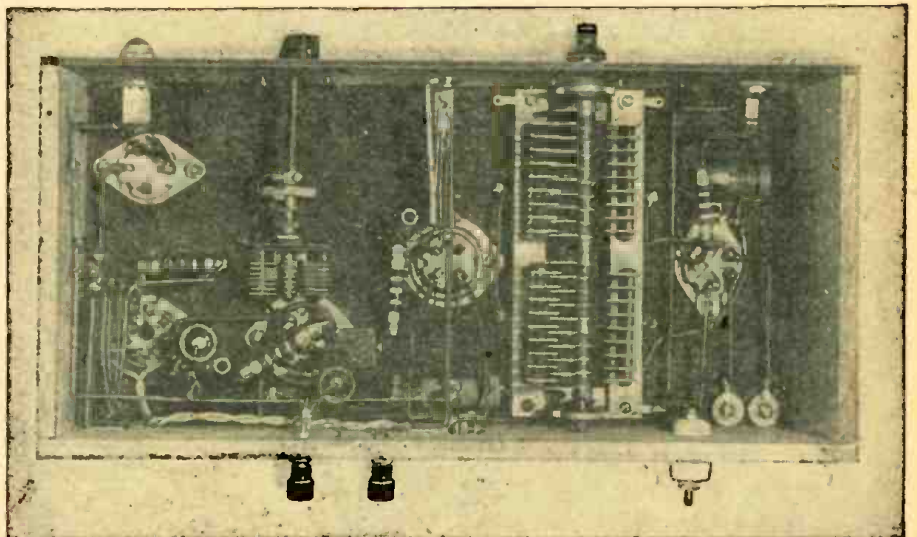

Photo B—Under-chassis view of transmitter, showing layout. Larger condenser is plate tuner.



# WAR SURPLUS SALES

## RADIO-ELECTRICAL-ELECTRONIC EQUIPMENT - PARTS - SUPPLIES

- PHILCO TANK ANTENNA**—all aluminum copper weld; dark grey finish; 12 feet long, in 3 sections; weight 10 lbs.; base 5/16" dia. tip 1/4". Very special. **\$ .98**
- WESTERN ELECTRIC or SYLVANIA 1-N-21; 1-N-23 Crystals**, 35c each. 3 for **1.00**
- CRYSTALS 5000 KC** complete in holders **1.95**
- 2" METER**, bakelite case, 1 mil dc **2.25**
- WESTON**—2" Meter, Model 508 metal case 1 1/2 mil. DC **2.50**
- GE 2" Meter**, Model 8 DW 44, bakelite case; 0 to 1 amp. RF **2.50**
- STANDARD RACK CABINETS** heavy gauge steel, gray crackle finish; panel opening 19" wide, 27" high **12.95**
- SUPERIOR 2 KVA Power Stats**; input 115 volt AC, 50-60 cycle single phase, — output voltage range 0-135 volt; maximum rated output current 15 amp available over entire range of output voltage; weight approx 20 lbs. **29.50**
- SUPERIOR 2 KVA 3 1/2 KW power stats**, 2 in tandem, each 115 volt AC single phase. Same as the above but twice the input and output voltage **54.50**
- ZENITH-BENDIX or RAWLINS Frequency Meters** 125 to 20,000 kc BC 221 with original crystals; complete with spare tubes and calibration book, each one tested, guaranteed **54.50**

Many other interesting items Prompt Delivery

25% deposit required on each order Shipped F.O.B. New York—Minimum Order \$2.00

**MICHAEL STAHL, INC.**

39 RCJ VESEY ST.  
Tel. Cortland 7-5980 New York 7, N. Y.

*new!*

## DE LUXE BINDER



**PROTECT** your back issues in this new beautiful De Luxe Binder, tailor-made to fit 8 issues of RADIO-CRAFT.

Start now to keep your magazines clean, fresh-looking for instant reference—instead of lying around helter-skelter, torn, dog-eared and soiled... very likely lost. This De Luxe binder is attractive enough to dress up your living room library shelves.

Well-constructed, finished in simulated Morocco leather, rich russet brown with gold embossed lettering and design on front and back. 9" x 12 1/2" with 1 1/2" back. No punching of magazines necessary. Just slip your RADIO-CRAFT magazines through a metal strap built into the binder. In a jiffy they are in place and overlastingly protected.

### 5-DAY FREE TRIAL

The De Luxe Binder is guaranteed to more than satisfy. If not, return within 5 days and your money will be cheerfully refunded. Sent postpaid in U.S. on receipt of \$1.50. (Canadian and Foreign \$1.75.)

**RADIO-CRAFT**

25 West Broadway, New York, 7, N. Y.

circuit is adjusted for minimum current, which will be from 10 to 25 ma depending on the plate voltage.

A low-impedance antenna may be coupled directly to the link winding on the output coil. An antenna coupler should be used with other antennas to provide more efficient matching. The coupler shown on the schematic is designed for operation on the 80-meter band and is used to couple a single-wire antenna feeder to the transmitter. The tuned coil, L5, consists of 28 turns of No. 18 bell wire closely wound on a 3-inch form. A 3-turn link, L4, is wound over one end and has leads long enough to reach to the transmitter output terminals. The larger coil is tuned by a 75- to 100- $\mu$ f condenser. Coils for other bands may be wound using between 10 and 15 percent more turns than the amplifier coil if the diameters and tuning condensers are equal. End-linked manufactured plug-in coils may be purchased for each band.

When tuning the coupler to load the antenna, it is very desirable to have an antenna current meter (r.f. thermo-couple ammeter). If one is not available, ordinary light bulbs clipped between the coupler and the feeder may be used to indicate the relative values of current drawn by the antenna by the brightness of the bulbs. Do not attempt to load the antenna too heavily. If the loading is held down to manufacturer's ratings, better performance will be obtained and tubes will last much longer.

### COIL DATA

- 80 Meters L1—27 turns spaced to 1 1/2 inch  
L2—25 turns spaced to 1 1/4 inch  
L3—8 turns
- 40 Meters L1—16 turns spaced to 1 1/2 inch  
L2—15 turns spaced to 1 1/2 inch  
L3—8 turns
- 20 Meters L1—12 turns spaced to 1 1/4 inch  
L2—9 turns spaced to 1 1/2 inch  
L3—2 turns

All coils are wound on 1 1/2 inch forms with No. 16 enameled wire. L3 is wound around, or close to the lower end of the L2.

Light is being used in a new system of relaying television programs. A cathode-ray tube is used to transmit the television-modulated light beam, and a photocell to turn it back to electric impulses for retransmission.

## MIND POWER

### A FREE BOOK

Develop your personal, creative power! Awaken the silent, sleeping forces in your own consciousness. Become Master of your own life. Push aside all obstacles with a new energy you have overlooked. The Rosicrucians know how, and will help you apply the greatest of all powers in man's control. Create health and abundance for yourself. Write for Free book, "The Mastery of Life." It tells how you may receive these teachings for study and use. It means the dawn of a new day for you. . . Address: Scribe W.K.T.

**The ROSICRUCIANS**  
SAN JOSE (AMORC) CALIFORNIA

**RTS RADIO TUBE SERVICE CO.**  
1945 70th St. Brooklyn 4, N.Y.

Let **RTS** reprocess  
your dead **RADIO AND TELEVISION TUBES**

**NEW Scientific Process**  
**REACTIVATES THORIUM**  
**CONNECTS OPEN FILAMENTS**  
**CLEARs SHORTS and**  
**MICROPHONICS**

MINIMUM ORDER 6 TUBES  
SEND NO CASH **50¢** EA  
C.O.D. ONLY  
**30-DAY GUARANTEE**

Every tube fully tested in checkers and sets for playing

Send itemized list with order Make sure glass, base & prongs are intact . . . flashed, exploded or open cathodes REJECTED and NOT RETURNED.

**New tubes, amplifiers, wire recorders, radios, and all electronic equipment.**

Machines used for reprocessing Radio Tubes are available. WRITE FOR DETAILS.

## This Month's SPECIALS

At Greenwich Sales

**U. S. ARMY SIGNAL CORPS CODE TRAINING SET #AN/CSC-T1.** Will operate from 6, 12, 24, 115 VDC or 115, 230 VAC 60 Cy. Phones, speaker or blinker operation. Suitable for group or individual training. **BRAND NEW Complete with \$19.00** tubes and compact carrying case

**TWO WAY INTERCOM SET.** 115 VAC 60 Cy. Beautiful compact case, substation black crackle cabinet. Volume control, switches, pilot lamp, 3 tube amplifier. Shipped complete, one master station, one substation, 100 ft. wire, tubes. Ready to plug in and operate. Ideal for home, office or industrial. Additional stations easily added. **\$33.00** Guaranteed.

SEND FOR BI-MONTHLY BULLETIN CR

25% deposit required on all orders. Prompt delivery assured.

**GREENWICH SALES CO.**

59 Cortlandt St. — Whitehall 3-3052  
New York City 7, N. Y.





1907-1947

We honor you, Dr. Lee de Forest on the occasion of the 40th Anniversary of your vacuum tube, the historic audion.

# In New Jersey . . . . . . it's VARIETY

## SUPERIOR Model CA-12



### FEATURING

Simple Operation... only one connecting cable... No tuning Controls. A new Superior Instrument Product. Complete with Probe, Test Leads, Batteries and Instructions.

Price 34.85

## SUPERIOR Model 670

### SUPER-METER



A Combination Volt-Ohm Milliammeter plus Capacity Reactance Inductance and Decibel Measurements. Complete with test leads and instructions

\$28.40

## Radio Kits by "EASY BUILT"



MODEL NO. 2B  
Battery operated, easy tuning, attractive wood finish cabinet. Complete with Tube, Coil, Battery, Headphone, Hardware and Base.  
List Price, \$4.98

\$3.33

### SPECIAL

No. 2 KIT. AC-DC. Electric Battery Kit with Cabinet complete with Tube, Special Variable Condenser, Earphones, Resistors, Hardware and Special Fittings, Completely Wired Tube Socket. Diagram on Mounting Base—Ready Cut and Drilled. \$5.01 each

Kit No. 1 .....\$2.13

Kit No. 1X .....\$2.13

### Federal Teleco Selenium Rectifier

Replaces Rectifier Tube .....\$1.09 each  
6 or more 99c each

## BARGAINS!

### 100 ASSORTED BYPASS CONDENSERS

- |               |              |
|---------------|--------------|
| 10—.001—600V. | 10—.02—600V. |
| 15—.002—600V. | 10—.05—600V. |
| 10—.005—600V. | 10—.1—600V.  |
| 15—.006—600V. | 10—.5—200V.  |
| 10—.01—600V.  |              |

Value .....\$11.00

Special—\$6.95

Write Dept. C1 for our FLYER. 20% Deposit with order required. Please add sufficient postage. Excess will be refunded.

Variety ELECTRIC CO., Inc.  
601 Broad St., Newark 2, N. J.

## THE 'SCOPE—A REPAIR TOOL

(Continued from page 69)

### A.F. SECTION

The quick check point for this section is test No. 9 in the table. When a 400-cycle a.f. signal from the signal

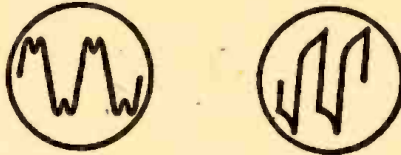

Fig. 2—Two distortion patterns often viewed.

generator is fed into the set as indicated in the table, satisfactory (or unsatisfactory) operation of the entire audio system is determined. The presence of distortion will easily be recognized by a flattening or peaking of the sine wave, and a little experience will readily establish the amount of gain that can be used without introducing noticeable distortion. If satisfactory operation is not sufficiently definite at this point, we retrace our steps to pick up possible causes of trouble. In the case of insufficient audio output from the set, the obvious possible offenders such as the audio tubes and the output transformer are suspect. In the case of distorted output from the set, we look for conditions that might cause improper bias, such as improper biasing resistor, open bypass condensers for the bias resistor, leaky coupling condensers or improper functioning of the tone control. Common distortion patterns are shown in Fig. 2. Each of the above conditions can be located at its source by starting from the output transformer and moving backward by detailed steps as shown below.

### DETAILED TROUBLE LOCATION

Test No. 4 checks output transformer operation; test No. 5 shifts the injected signal to the grid of the 50L6 power tube. The audio output shown on the oscilloscope, with all other controls left unchanged, should be noticeably greater. Gain may be measured either by high-resistance voltmeter or calibrated oscilloscope screen. For Test No. 6, we check the coupling condenser from the 12SQ7 plate to the power tube grid. Watch here for distortion introduced by a slightly leaky coupling condenser. At this point, if a tone control is present, its operation can readily be checked by Test No. 7. (Although the illustration given here does not use a variable tone control, a modified form of fixed audio filtering is provided by the first audio plate bypass condenser, 0.001  $\mu$ f. In this case, the effect of the audio filtering can be determined, if suspected, both by ear and oscilloscope indication by opening this bypass circuit). When a variable tone control is present its effect can be investigated easily, paying special attention to its effect on the filtering of both low and high passages.

# LOOK at this Value!



PORTABLE VOICE AND CODE RADIO

## RECEIVER-TRANSMITTER

Self-Contained 200 KC Calibrated Crystal

BC-654-A is a combined transmitter and receiver designed for portable or vehicular operation. The frequency range of both transmitter and receiver is continuous from 3700 to 5800 kilocycles; all stages gang tuned by anti-back lash worm gear dial mechanisms.

The BC-654-A is 18" wide, 14" high, and 9 1/4" deep. Weight 44 1/2 pounds. Power required for Receiver—1.5, 45, and 90 volts D.C. Power required for Transmitter—1 1/2, 6, 51, 84 volts D.C. and 500 volts D.C. at 160 ma. Operates from Dynamotor PE-103-A.

Balance of stock being closed out at this low price (as is) . . . \$22.95  
(Complete with case less dynamotor)

One-third deposit with order, balance C.O.D., F.O.B. shipping point. For check with order, shipping charges prepaid.

## D. & H. DISTRIBUTING CO., INC.

721 E. Cameron Street, Harrisburg, Penna. PARTS DIVISION 21 East Lee Street, Baltimore 2, Md.

1907-1947

We honor you, Dr. Lee de Forest on the occasion of the 40th Anniversary of your vacuum tube, the historic audion.

## INCREASE YOUR INCOME—Doing ELECTRIC WIRING—APPLIANCE & MOTOR REPAIRING

New, modern theory gives you better knowledge of electricity in fewer hours of study—gives you better chance for success whether doing electric wiring, servicing or repairing electrical apparatus.

### APPLIANCE & MOTOR REPAIRING

Start immediately! No burdensome studying necessary. Repair vacuum cleaner by simply following easy step-by-step procedure given on cleaner work sheet. Same method used for washers, irons, toasters, motors, etc.

Complete training only \$2.95. NO EXTRAS!

**DON'T WAIT!** Order this training today! If not satisfied after ten days, return it and your money will be refunded.

Same trial period applies to cash or C. O. D. orders. We pay postage on orders accompanied by cash, check, or M.O.

Sunbury Engineering Works, Box 129, Dept. D, Sunbury, Pa

## ELECTRONIC VOLT-OHMMETER

\$11.85 POSTPAID  
110 VOLTS AC 20 RANGES  
0/5/10/50/100/500/1000/5000 volts DC and AC. 0-1,000,000 ohms in six overlapping ranges. Sensitivity: over MILLION OHMS per VOLT on 5 volt range.

Complete kit includes all component parts, tubes, punched and drilled chassis and beautifully enameled panel. Easily assembled and wired.

Special feedback circuit developed during war by scientist at the California Institute of Technology gives amazing sensitivity and flexibility with completely eliminating necessity of batteries and expensive resistor. Each instrument is individually calibrated. Dial scale over nine inches long!

In addition to performing the usual volt-ohm functions, this instrument easily measures these voltages: SUPPLY HT. OSCILLATOR. AVC. AFC. TRUE GRID BIAS AT THE GRID. BIAS CELLS without affecting the circuit. Measures the exact leakage resistance of INSULATION, TUBES, CONDENSERS. It can be used with a signal generator for SIGNAL TRACING.

### STERLING ELECTRONIC COMPANY

166 N. Sierra Bonita Ave., Dept. 2, Pasadena 4, Calif.



famous for

# GREAT VALUES

## OUTSTANDING OFFERINGS OF NEW KITS

### H-101 Five Tube Superheterodyne Kit

Small Bakelite cabinet approximate size 9"x5"x8", complete parts except wire and solder for the construction of a standard superheterodyne receiver using 50L6, 8525, 12SA7, 12SQ7, and 12SK7. A simplified circuit diagram included in this kit enables any one with a slight knowledge of radio to construct a highly efficient receiver. Price not including tubes ..... **\$10.75**

### H-105 Automatic Record Changer Kit

Consists of 1 Automatic Record changer, single post; 1 Portable leatherette cabinet for above; 1 Crystal pick up; 1 5" P.M. and output transformer; 1 complete kit of parts including tubes but excluding wire and solder, to construct a 3-tube amplifier using 1-50L6, 1-35Z5, and 1-12SQ7. Price complete ..... **\$36.95**

All prices are F.O.B. New York City.

Write for our new catalogue showing new test equipment, tubes and a large variety of new replacement parts. We ship anywhere in the U.S.A.—promptly.

## RADIO DEALERS SUPPLY COMPANY

135 LIBERTY ST., NEW YORK 6, N. Y.

now you can

**SEE and HEAR** the signal with the new **CA-12**

## Signal Tracer

### FEATURING

Simple Operation... only one connecting cable... No tuning Controls. A new Superior Instrument Product. Complete with Probe, Test Leads, Batteries and Instructions.

Price **34.85**

We handle a complete line of Radio Parts and Tubes. Write for the latest LIFETIME BULLETIN just off the press. Thousands of money-savers in parts, supplies, equipment. Address

## Lifetime

**SOUND EQUIP. CO., Dept. 25**  
911-913 JEFFERSON AVE., TOLEDO 2, OHIO

Hazards to industry are caused by static discharges which may produce dangerous sparks. One solution of the problem is a coating containing radio-active salts, applied to all charge-collecting surfaces. Rays from the salts ionize the air, allowing charges to leak off.

RADIO-CRAFT for JANUARY, 1947

(Continued from preceding page)

Whether it is profitable to do a quantitative frequency-run test from a variable-frequency audio oscillator is again left to the discretion of the technician. It is generally not necessary in a speedy check. (An alternative method for making such a frequency run is given later in Test No. 18.)

Test No. 8 checks the amplifying properties of the 12SQ7 first audio tube. Care should be taken here, as this point provides the full audio amplification (a gain of over 300, as shown in the PhotoFact diagram Fig. 1), and will therefore be very sensitive to a.c. hum picked up through the external connections. An example of this is the loud hum effect produced by touching the first audio tube grid with the finger, which transfers all the a.c. voltage induced in it by the presence of one's body in the neighboring a.c. field.

With ordinary care and understanding of the situation, however, this condition need not interfere either with this test or with the following over-all Test No. 9 which has been covered previously for giving an indication of the system's overall performance.

### OSCILLOSCOPE REQUIREMENTS

Before proceeding with further investigation of the i.f., oscillator, and r.f. sections of the receiver (which are covered in the second part of the article), the use of such high-frequency signals from the signal generator brings up the question of the ability of the oscilloscope to follow faithfully these operations. A complete discussion of this point is left to a later section of the article. Suffice it to state here that the method used for the r.f. sections will involve obtaining patterns which, in every case, will show the demodulated output of the set and will therefore require only an audio-frequency response range from the oscilloscope. Such a response, to include evidence of wanted and unwanted harmonics, should extend preferably to about 50,000 cycles per second, combined with an associated sweep range of around 20,000 cycles.

The above requirements are met amply by most of the oscilloscopes on the market, from the new Dumont 5-inch Model 274 to the compact Pocketscope 2-inch Model S10-A. These are chosen as extremes of fairly representative types, although any of the 3-inch models produced by a number of service-minded manufacturers could well have been included.

(Note that Test 9 is a quick check point instead of Test 8, as printed on page 69.)

The second part of this article will appear in an early issue. Acknowledgment is made to the Howard W. Sams PhotoFact Service for the voltage gain data in Fig. 1.

Facsimile will be used by the Signal Corps in a weather station net to transmit actual weather maps between overseas weather stations and forecast stations in this country. Facsimile radio weather map service has already been installed between Hickam Field, Oahu, Hawaii, and Fairfield-Suisun, California.

## FACTORY CLEARANCE SALE

**CAPACITORS:** Oil-filled, C-D & Aerovox. Removed from equipment which was never used.

Bath-tub Type—600 volt dcw  
0.05 mfd ..... \$0.19  
0.50 mfd ..... .33  
0.25-0.25 mfd dual ..... .49  
1.0 mfd ..... .39  
2.0 mfd ..... .49  
Universal mounting, C-D Type TJH & Aerovox Type N  
10.0 mfd, 600 volt dcw ..... .98  
10.0 mfd, 1,000 volt dcw ..... 1.50

**CAPACITORS:** Electrolytic, new.

20 mfd/150 volts dcw—1,000 mfd/5 volts, dcw, dual ..... .49  
20-60 mfd, 400 volts dcw, dual ..... .59  
**SELSYNS:** 115 volt, 60 cycles, Bendix Type I-1, pair ..... 7.50

**CIRCUIT BREAKERS:** Heinemann, 15 Amp & 5 Amp, 115vac ..... .98

**TRANSFORMERS:** Impregnated and sealed in steel cases. Thordarson, UTC, Stancor, etc. 115 volt 60 cycle primaries.

Filament: 6.4 volts @ 8.5 Amps ..... 1.89  
Filament: Sec. 1, 2.6v @ 10.0 Amps; Sec 2, 6.4v @ 5.5Amps, Sec 3, 6.4v @ 1.0 Amp ..... 3.49

Plate: Sec 1, 1,280v @ 262ma CT; Sec 2, 18v @ 1.0Amp ..... 6.95

**RHEOSTAT:** 3,000 ohms, 5%, 25 watts 1.59

**POTENTIOMETERS:** 5,000 ohms, wire-wound, 5% ..... .29

100,000 ohms, 10%, Taper "A" ..... .29

**TUBES:** New, not in cartons. RCA, Sylvania, Ken-Rad, WE.

6AC7/1862 ..... .99

6SJ7 ..... .49

6SL7 ..... .69

6SN7, VR-105/30, VR-150/30 ..... .59

6L6, 6L6G ..... .84

6AK5 ..... 1.79

6X5GT/G ..... .76

2AP1, 2" CRT ..... 3.95

5HP4, 5" CRT ..... 6.95

**RELAY:** Struthers-Dunn, SPDT, 18vac coil, 115vac, 8Amp contacts ..... 2.00

ALL PRICES NET. F.O.B. FACTORY

## Cambridge Electronics Corporation

Manufacturers of Electronic Control Equipment  
Pulaski & McHenry Sts., Baltimore 23, Maryland

## ELECTRICAL BOOKS

shipped for EXAMINATION



8 BIG BOOKS

SEND NO MONEY MODERN ELECTRICITY INCLUDING RADIO AND REFRIGERATION

Here's great news for anyone interested in Electricity. NEW, up-to-date 19th Edition of Applied Electricity with new subjects fully covered, including blueprint reading, electronics, F. M. radio, fluorescent lighting, 8 Big Books send for examination:

NEW Edition for Beginners and Experts

Over 3700 pages, 2700 illustrations and 134 tables in most complete electrical work we have published.

Dynamos, motors, diesel plants, power stations, transmission—everything explained for easy understanding.

### BIG FIELD! Big Demand!

Men who understand electricity are needed now in all kinds of industries. Practically every business depends on electrical knowledge, and men who know this subject make big money. Learn easily with these new, interesting books. Send coupon for a set of books on approval. See how they will help you to get ahead faster.

A year's consulting privileges with our engineers now given to all buyers of this famous Cyclopedic of Electricity.

SEND NOW AMERICAN TECHNICAL SOCIETY Vocational Publishers Since 1898

American Technical Society, Dept. E126, Drexel at 58th St., Chicago 37

Send for 10 days' free use. 8 volume set of New 19th Edition, Applied Electricity, including a certificate entitling me to consulting privileges for one year. I will pay the delivery charges only on the books. If I wish I may return them in 10 days and owe you nothing; but if I keep them, I will send \$2.00 after 10 days, then \$3.00 a month until the total price of only \$34.80 is paid.

NAME .....

ADDRESS .....

CITY ..... STATE .....

Please attach letter stating age, occupation, employer's name and address and name and address of at least one business man as reference. Men in service, also please give home address.



# Free Radionic Catalog



**RADIONIC EQUIPMENT CO.**  
170 Nassau St., Dept. 101, New York 7, N. Y.

Please send me a FREE copy of your 1947 Catalog. I understand it has thousands of items illustrated, described and priced and will be a great help to me in my search for "hard-to-find" radio equipment.

Name .....

Address .....

City ..... State .....

## EASY TO LEARN CODE

It is easy to learn or increase speed with an Instructograph Code Teacher. Affords the quickest and most practical method yet developed. For beginners or advanced students. Available tapes from beginner's alphabet to typical messages on all subjects. Speed range 5 to 40 WPM. Always ready—no QRX!



**ENDORSED BY THOUSANDS!**  
The Instructograph Code Teacher literally takes the place of an operator-instructor and enables anyone to learn and master code without further assistance. Thousands of successful operators have "acquired the code" with the Instructograph System. Write today for convenient rental and purchase plans.

## INSTRUCTOGRAPH COMPANY

4701 Sheridan Rd., Dept. RC, Chicago 40, Ill.  
**The BUY of a LIFETIME**

U.S. SIGNAL CORPS **5 Meter** ONLY \$349  
**SHORT WAVE XMTRS.** }  
(72.2 Mc) **3**

**XMTR and Tube Only** Less mtk, Batteries and Antenna

One 1½ volt dry cell and 67½ volts of B operates it. Just attach di-pole, key or mike, connect the batteries and it's ready to use. Signal Corps spec wired with silvered wire, mica condensers, and precision resistors. Highly stable circuit with Lo-Loss silvered inductance. (Adjustable paddler.) Schematic supplied. Converts to walkie-talkie and Ham bands. Weighs less than a pound. Shipped by express only. No C.O.D.'s. No Parcel Post. A sacrifice at only \$3.49. Postal or express money order or certified check.

**NEWARK SURPLUS MATERIALS CO.**  
324 Plane St., Dept. C, Newark 2, N.J.  
SEND STAMP FOR GIANT CATALOG!

## YOUR ELECTRIC DRILL Has 100 Other Uses

when used with K-Jax attachments  
**METAL SAWING SHEARING**  
**RIVETING ATTACHMENTS**

Ask your Hardware dealer or write for illustrated circular  
**K-JAX, 2600 Canton St., Dallas, Texas**

## MULTITESTER V.T.V.M.

(Continued from page 83)

otherwise the entire current, about four or five ma, will pass through the meter and might damage it.

The e.v.m. section, shown in dotted lines on the diagram, and for which due credit is given Mr. Davis, is an excellent instrument and constructed almost exactly as described in his article. The only change is an additional switch in the B battery lead (section F on Sw2)

else there would be a continuous drain on the battery. It has its own test leads—a few feet of shielded microphone cable with a 1-megohm resistor in the probe end was more stable and eliminated a good deal of the hand capacity which was present with ordinary leads. In addition to the many uses suggested by Mr. Davis, the e.v.m. is an efficient instrument for testing crystal pickups

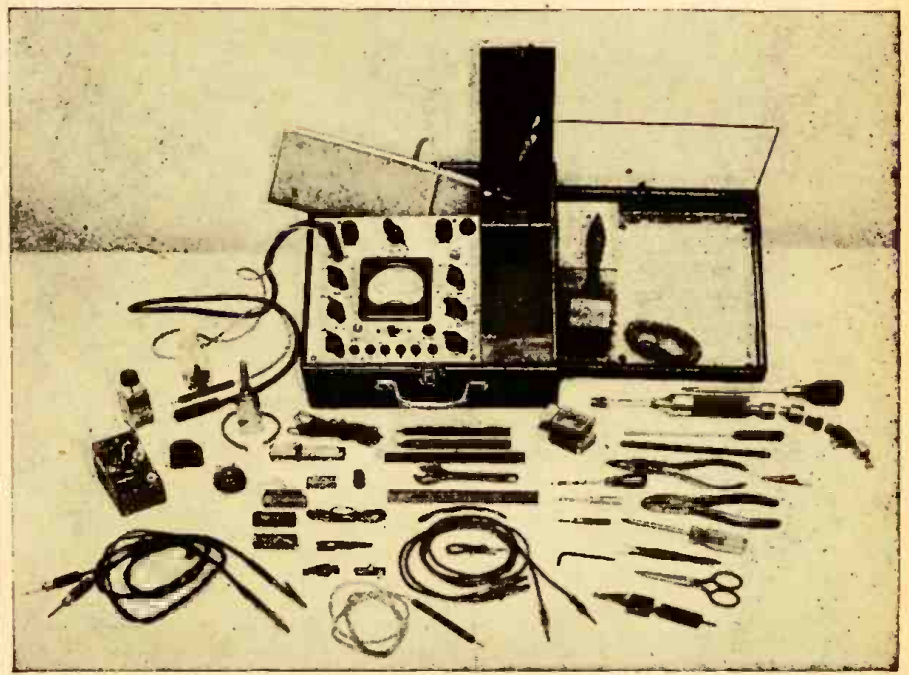

All this equipment came from the tool and test-prod compartments. Everything went back, too!

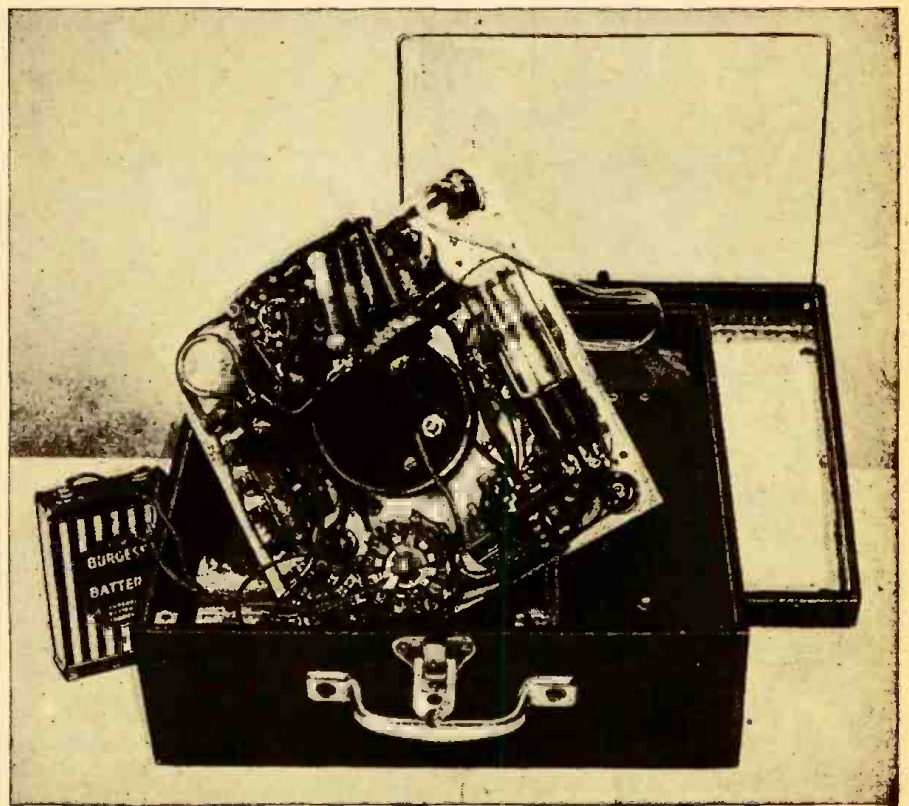

This underchassis view of the combination tester shows how the vacuum tube is mounted.



—by connecting pickup leads of a suspected crystal and playing a record, a good crystal will show an appreciable reading on the meter. This is a good practical test before yanking out the crystal and then afterward deciding that the trouble is elsewhere. The reversing switch (Sw4) operates with either instrument, as does the a.c.-d.c. switch.

There was still room on the panel for another gadget so a test socket for pilot bulbs was installed in the upper left-hand corner. It saves the time and trouble of using a pair of test leads.

### TRANSMISSION WITH LIGHT

(Continued from page 63)

the light intensity at the receiver varies directly as the square of the radius of this lens and inversely as the square of the distance between it and the receiver—assuming that the *object*, the neon tube anode, has been carefully focussed so that a sharp image appears at the photocell. Hence doubling the distance between the units will produce a 75 percent reduction in light input to the receiver, with consequent loss in volume. However, one can compensate for this effect by using a larger lens at the photocell, since a 2-inch lens will pass four times as much light as a 1-inch lens.

In the system described, using 4-inch and 1-inch lenses at the transmitter and receiver respectively, good reproduction was obtained at a distance of 15 feet. Had a 4-inch instead of a 1-inch lens been used ahead of the photoelectric cell, this range would have been greatly increased.

Insofar as the average experimenter is concerned, the immediate practical uses of a light-beam system are almost nil. Yet these efforts are definitely profitable. Besides the pleasure involved, and the fact that two very passable amplifiers are built, one has to tangle with some interesting problems of amplifier design and applied optics, with a few bits of photoelectric theory on the side.



Can supply you with all types of Radios, Radio parts, Electrical parts and accessories.

### PREPAID ASSORTMENTS GUARANTEED FIRST QUALITY

100	1/3 Watt Resistors All Insulated.....	\$2.98
100	1/2 Watt Resistors All Insulated.....	3.98
100	1 Watt Resistors All Insulated.....	4.45
50	2 Watt Resistors All Insulated.....	3.98
50	200 Volt Paper condensers.....	2.48
50	Mica Condensers.....	2.98
20	Dry Electrolytic Filter Condensers.....	6.75
10	25 ft. Rolls Hookup Wire—Ass't'd colors	1.98
10	Volume and Tone Controls—No Switches	1.98
100	ft. Spagetti and Vinylite.....	.98
10	Coils I.F. R.F. Ant. and Osc.....	3.98
20	Water and Ceramic Band Switches.....	3.98
20	Auto Suppressors.....	2.98
50	Electrical Wiring Devices, Plugs, Taps, Bases, Elements, Fuses, etc.....	5.00

SEND FOR TRUTONE COMPLETE RADIO AND ELECTRICAL LIST

Terms: 25% deposit required with order. Balance C.O.D. Merchandise sent prepaid if full remittance accompanies order.

**TRUTONE PRODUCTS CO.**

803 W. 42nd St. Dept. C New York 18, N. Y.

# Automatic Combinations—NOW!

## The New Arnold Shure Automatic Wired Record Player Ready For Immediate Delivery!

The Shure automatic record player connects easily to any radio. Its feather-weight crystal pickup and quiet, smooth changer action assure high quality playing of ten 12" records or twelve 10" records. Every one of your customers can now own a fine automatic combination at a remarkably low cost.

Shure players are shipped complete with A.C. cord and shielded cable—only 2 wires to connect and it's ready to play.

Your price only **\$21.92 net**  
F.O.B. CHICAGO, ILLINOIS

OPA Retail Price \$31.30 Zone 1  
OPA Retail Price 33.87 Zone

Orders are now being accepted for immediate delivery—no waiting. Terms: 2% check with order. Or 25% deposit, balance express C.O.D.

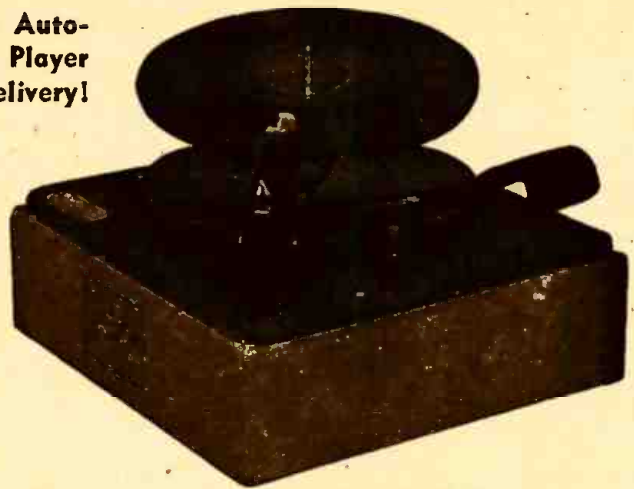

### PHONO AMPLIFIERS

1-Tube Phono. Amplifier.....	\$2.35 ea.
2-Tube Phono. Amplifier.....	4.50 ea.

### PM SPEAKERS

1" Alnico (5) PM Speaker.....	\$1.39 ea.
2" Alnico (5) PM Speaker.....	1.48 ea.
3" Alnico (5) PM Speaker.....	1.89 ea.

### TUBULAR ELECTROLYTICS

100-MFD-25 V.....	\$ .22 ea.	10-MFD-450 V.....	\$ .29 ea.
10-MFD-50 V.....	.22 ea.	16-MFD-450 V.....	.39 ea.
20-MFD-150 V.....	.22 ea.	10-10-MFD-450 V.....	.58 ea.
30-MFD-150 V.....	.29 ea.	20-20-MFD-150 V.....	.29 ea.
40-MFD-150 V.....	.39 ea.	80-20-MFD-150 V.....	.3C ea.
50-MFD-150 V.....	.45 ea.	40-30-MFD-150 V.....	.45 ea.
6-MFD-150 V.....	.25 ea.	50-30-MFD-150 V.....	.59 ea.

## HOLLANDER RADIO SUPPLY CO.

549 West Randolph Street Chicago 6, Illinois

## MORE SMASH BUYS at National Radio Distributors

### NOW! IMMEDIATE DELIVERY!

THE NEW AND IMPROVED NATIONAL RADIO KITS. The Original and still the Finest. All parts brand new, No War Worn Surplus. All parts perfectly matched and mounted on chassis for easy wiring. Powerful Alnico P. M. speaker and beautiful Plastic Cabinet with Dust-Proof back furnished with all Kits. Built-in loop antenna, and Illuminated Airplane dial. Full instructions.

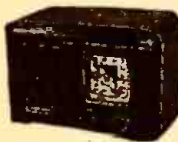

MODEL N.R. 7—5-TUBE 105-125v. A.C./D.C. SUPERHETERODYNE. Uses 12SA7, 12SK7, 12SQ7, 50L6 and 35Z5 tubes.....	\$11.95
Kit of 5 Matched Tubes.....	4.95
MODEL N.R. 5—5 TUBE TWO BAND A.C./D.C. SUPERHETERODYNE, as above. Freq. Range 550-1800 K.C. and 5.5-18 Megacycles.....	\$13.95
Kit of 5 Matched Tubes.....	4.95
MODEL N.R. 6—6-TUBE A.C./D.C. SUPERHETERODYNE. Uses 12SK7, 12SA7, 12SQ7, 35L6, and 35Z5 TUBES.....	\$13.75
MODEL N.R. 1—4 TUBE A.C./D.C. T.R.F. Uses 12SK7, 12BJ7, 50L6 and 35Z5 Tubes. Highly recommended for Students, Schools Hospitals and Institutions.....	\$10.95
Kit of 4 Matched Tubes.....	3.95



### MODEL P. R. 7—PORTABLE RADIO-PHONOGRAPH COMBINATION KIT

- Powerful 5-Tube Superheterodyne Radio, with Self-Contained Loop Antenna and Alnico speaker.
- Self-Starting Phono-Motor, and Feather-Weight Crystal Pick-up arm, 9" Turn-Table.
- Luxurious Leatherette covered carrying case...\$27.50

Kit of Matched Tubes 5..... 4.95

Manufacturers, Jobbers, Exporters! Write for quantity prices. White Plastic Cabinets available for Radio Kits, \$1.00 additional. Terms: At least 25% with order. We will ship balance C.O.D.

WRITE FOR OUR COMPLETE CATALOG. IT'S FREE.

## National Radio Distributors

899 r Southern Blvd., New York 59, N. Y.

## FOR SALE

Wire, 12,000 ft. Gov't RGU/#8. Radio Frequency, Low Loss Cable, copper wire, shielded about 52 ohms, 1000' coils on wood reel, \$.07 per ft., if cut 100' lengths, \$.09 ft.

**Lyell Hardware Co.**

BOX 5 ROCHESTER, N. Y.

## AMATEURS AND EXPERIMENTERS

Hundreds of radio and electrical parts includes—1 Throat Mike. . . Resistors . . . Sub Assemblies . . . Contact Points . . . Condensers . . . Insulators . . . Coils . . . Sockets . . . etc., etc., etc.

PRICE ONLY **\$2.00** EACH KIT

SHIPPING WEIGHT 10 LBS. TERMS CASH WITH ORDER F.O.B. CHICAGO, ILL.

**GEORGE BROOKS & ASSOCIATES**  
220 SOUTH HALSTED STREET CHICAGO 6, ILLINOIS

## PEN-OSCIL-LITE

Extremely convenient test oscillator for all radio servicing; alignment • Small as a pen • Self-powered • Range from 700 cycles audio to over 800 megacycles u.h.f. • Output from zero to 125 v. • Low in cost • Used by Signal Corps • Write for information.

### GENERAL TEST EQUIPMENT

38 Argyle Ave. Buffalo 9, N. Y.

## CORRECTION

Formula and text do not agree in the formula at the head of the second column, page 17 of the December issue. In the text, *v* is used to represent velocity of sound, but by error an *x* is used in the formula. The caption on Photo D is also in error, and should read "... fixed light and moving scale."



## HOLIDAY GIFTS SPECIALLY PRICED KITCHEN FLUORESCENT UNITS

Uses 2-15  
or 2-20  
Watt Lamps  
AC or DC  
Lamps 80c each  
U/L Approv-  
parts



\$4.50

Plugs right into your fixture

**VM MIXER RECORD CHANGER \$16.50**

MAGUIRE 2-POST CHANGER .....\$15.25

DETROLA RECORD CHANGER .....\$15.95

ASTATIC L-70-A

SHURE GLIDER

CURVED ARM

CRYSTAL PICKUPS

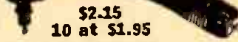

\$2.15

10 at \$1.95

### PHONO AMPLIFIER

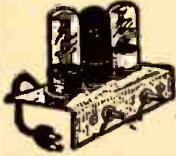

3 Tube AC-DC  
Completely Wired  
Volume and  
tone controls ... **\$2.95**

**Phono. Amp. Kit**

with 5" Spk. & tubes...\$7.95

Loss tubes or spk....\$5.95

Uses 12SQ7, 50L6, 35Z5.

Above kit wired...\$8.50

100 Asst. Insulated Resistors .....\$1.75

15 Asst. BY-PASS Cond. All 600 X ..... .85

25 Asst. Mike Cond. Color Coded ..... .85

PL-55 Mike Plugs with lock nuts ..... .15

Open circuit jacks ..... .12

Alliance phono motors and turn-tables ..... 8.75

### RISCO RECORD PLAYER

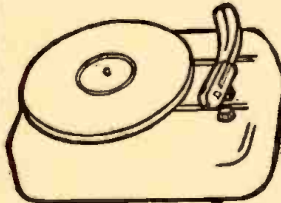

Easily attaches  
to any radio.  
Heavy duty motor. Walnut finish. High output.

**\$9.95**

with built in  
amplifier and  
tubes...\$15.95

We Specialize in Mail-Order Accounts  
25% Required on C.O.D. Orders—Free Catalog C1

### RISCO SALES CO.

WHOLESALE DISTRIBUTORS

22 Warren St. New York 7, N. Y.

## OPPORTUNITY AD-LETS

Advertisements in this section cost 20 cents a word for each insertion. Name, address and initials must be included at the above rate. Cash should accompany all classified advertisements unless placed by an accredited advertising agency. No advertisement for less than ten words accepted. Ten percent discount six issues, twenty percent for twelve issues. Objectionable or misleading advertisements not accepted. Advertisements for February, 1947, issue must reach us not later than December 29, 1946.  
Radio-Craft • 25 W. 87th St. • New York 7, N. Y.

**BARGAINS: TUBES, PARTS, ETC. SEND FOR LIST.**  
Joe T. Morrow, Wolfe City, Texas.

**ARMY SURPLUS, NEVER USED J-37 KEYS ON J-47**  
Bakelite Base. 89c ea. postpaid. The Gateway Co., P. O. Box 926, Brockton, Mass.

**CORRESPONDENCE COURSES AND SELF-INSTRUCTION**  
books slightly used. Sold, Bented, Exchanged. All subjects. Satisfaction guaranteed. Cash paid for used courses. Complete information and 100-page illustrated bargain catalog Free! Write—Nelson Co., Dept. 39, Chicago 5, Ill.

**"DRAWING—CARTOONING MANUAL," 31 LESSONS,**  
600 illustrations, complete \$1.00. Howard Sales, 6749 Clyde St., Forest Hills, N.Y.C.

**WHY FLUNK FCC EXAMS! GET THESE SIMULATED**  
multiple-choice FCC practice exams. Five for \$1.00. Five different exams each for Elements 2, 3, 4, 5 and 6. State elements wanted. Delo's of Denver, 510 15th Street, Denver, Colorado.

**ELECTRICAL SUPPLIES! EQUIPMENT. AMAZING**  
Value. New 110 volt, sixty cycle Ball Bearing Precision motors. Operate grinders, fans, etc. Cost government \$48.75. Sent express prepaid. Only \$3.69. Leeco Engineering Company, 908-RC-1, Lincoln, Nebraska.

**SIGNAL TRACER: SAVE \$17.45. I'M CLOSING SHOP.**  
Will sell brand new Spoco Model Stap AC-DC for \$27.50. Cost me \$44.95. Send check, money order or C.O.D. to M. H. B. Hoffman, 4112 Gallatin Street, Hyattsville, Maryland.

**WE REPAIR ALL TYPES OF ELECTRICAL INSTRUMENTS,**  
tube checkers and analyzers. Hazelton Instrument Co. (Electric Meter Laboratory), 140 Liberty Street, New York, N. Y. Telephone—BARclay 7-4239.

**MAGAZINES (BACK DATED)—FOREIGN, DOMESTIC,**  
arts, books, booklets, subscriptions, pin-ups, etc. Catalog 10c (refunded). Clacron's, 863 First Ave., New York 17, N. Y.

**AMATEUR RADIO LICENSES. COMPLETE CODE**  
and theory preparation for passing amateur radio examinations. Home study and resident courses. American Radio Institute, 101 West 63rd Street, New York City. See our ad on page 144.

**FREE WHOLESALE BULLETIN. TUBES, PARTS.**  
Bargain prices. Henshaw Radio Supply, 3313 Delavan City, Kansas City, Kansas.

**WANTED COPIES OF "MODERN ELECTRICS" AND**  
"Electrical Experimenter." State price. Box GT, % Radio-Craft.

# COMMUNICATIONS

## AN ATHENIAN VIEW ON POSTWAR RADIOS

Dear Editor:

I read carefully your article "Why No Postwar Radios" in the August issue. My present letter will not deal with the difficulties of production but will indicate some drawbacks inherent in even the best American prewar sets.

First is the quality of musical reproduction. Even the best American receivers compare unfavorably with good European sets. European listeners are accustomed to high-quality musical tone and do not tolerate anything that does not satisfy them acoustically.

Degenerative feedback was widely used in good European sets as far back as 1938. I still remember how surprised I was when I compared two superhets of the same make, one with degenerative feedback and the other without. The difference in musical reproduction was very pronounced indeed. Now I see, from data available, that not one of the

1946 American sets available here incorporates this design! I cannot understand how one can expect good performance without degenerative feedback and some means to boost the bass, especially in sets with small cabinets and speakers.

Another drawback is the poor performance on the medium-wave band. This may be attributed to the characteristics of American tubes and the intermediate frequency of 450 to 470 kc? With an i.f. of 128 to 175 kc we have better sensitivity and selectivity, in my opinion.

The latest models imported from the United States have not made a very favorable impression on the public here. Besides, their cost is prohibitive. They are sold at an average price of \$100, which represents two to three times the monthly average salary of an employee.

G. C. STAVRIDES  
Athens, Greece

## "GI IS SMALL MAN IN BUSINESS WORLD"

Dear Editor:

I have just been reading your Communications column in the September issue. It seems to me that too much griping is being done about the raw deal which the GI is getting after doing his duty for his country.

I am a GI myself and proud of the fact—but it isn't going to do any good to any of us GI's to complain because every civilian who hasn't seen service doesn't turn a flip-flop for us. Thousands of men who have seen service are back in civilian life trying to make a living. These men are strong, healthy and young and are able to make a decent living. The man who did not see service is not the youthful, healthy man

the GI is and is not able to go at the work the same. Those GI's who were left disabled are being taken care of by the government and are learning some trade which will enable them to make a living.

As for the RFC, the GI is getting the same old shaft again that is true, but then the average GI is only a small man in the business world. The big man has always got the break and he always will, GI or no GI.

We fought for our country on the battle fields—now let's fight for it at the polls, if we are not satisfied with the deal we get. How about it?

MAURICE S. HUDON  
Bradenton, Florida

## RADIO TERM ILLUSTRATED



Suggested by:  
M. Kosinski,  
Brooklyn, N. Y.

Thermionic Detector.



## IS SERVICE FIELD SUPER-SUPER-SATURATED?

Dear Editor:

Today, in this and other cities, it is common parlance to say "there is a radio man on every corner." That is pretty close to the truth. Three causes can be summed up into three reasons for the situation: 1. Old-timers in the radio-service field, who are still at it, or have come back into the radio service field after discharge from war service. 2. Those service men who have gained their knowledge while in the service of their country. 3. Those who have been, and are being ground out by the mail order radio institutions.

By way of contrast, we have in this city one principal and only telephone company, whose phone service extends into about three-quarters or more of the homes, and into all business places throughout the city. These phones need servicing from time to time, and are ready for service 24 hours of the day.

## NAZI TUBE REPLACEMENT

Dear Editor:

I have not noticed any article in your magazine describing successful substitution of our standard tubes in place of the tubes in the Nazi sets the boys are bringing over. I would like to contribute an item on this subject.

The set I worked on had all the tubes blown, it was a battery portable, Nora radio, using the following tubes, DCH11, DF11, DAF11, DL11.

After tracing out the tube pin connections, I removed the large bakelite sockets, substituted a bakelite disc with a midget socket installed in the center, in

A house radio may be in service anywhere from a few minutes to several hours daily. The entire number of telephone installations in this city, comprising about 18,000 phones, are maintained and serviced by eight or nine men employed by the telephone company for this purpose. The moral is obvious: if it takes but eight or nine telephone service men to maintain in service this large number of local telephones, then by what standard in numbers can we say that the number of radio service men are sufficient: or that the radio service field is saturated, super-saturated, or even super-super-saturated. From my own observation, I would say that the last-named situation is that now prevailing in the radio service field.

A. J. GALLAGHER  
Erie, Penna.

place of each one. I then rewired the sockets as follows:

DCH11-1R5, DF11-1T4, DAF11-1S5, DL11-1S4. The screen grid connection on the 1R5 was omitted.

The set worked fine, and the tubes did not require any shielding, although aligning was necessary, as the set has a regenerative i.f. circuit. The tone quality was good, indicating that the output transformer matched the 1S4 output tube very well. Perhaps this may help someone tackle a similar job.

WILLIAM BERGEN,  
Saskatoon, Canada

## SERVICEMAN'S ASSOCIATION IN PALESTINE

Dear Editor:

The radio technicians of Palestine founded an association in 1939 to promote radio service in the country. In the course of time we have acquired the confidence of the broad public as well as that of the respective authorities. At present, our association has some 30 members, all of whom are well-known technicians, most of them owners of workshops and some dealers at the same time.

You may be interested to learn that we have introduced consulting hours for the public, giving our clients advice free of charge regarding the purchase and the sale of radio sets, the use of same. At the same time we provided them with the opportunity of discussing all questions concerning their radio sets.

A Palestinian radio serviceman must be able to:

1. Repair radio sets of all types, no matter whether they are of American, Europe or Transcontinental make;
2. Carry out work without help of diagrams, without accurate spare-parts (the latter owing to war-time shortage)

and in the past also without facsimile tube-types (especially European tubes). We had to replace European tubes by American tubes, change sockets, change heater voltages (from 4 volts to 6.3), etc.

We are now in possession of an import license enabling us to order new test equipment for which we are in dire need. Thus, we have immediately ordered the necessary instruments for our members (such as oscilloscopes, signal generators, meters and combination-units). There is a large market for American radio sets and all sorts of radio merchandise in this country and we are anxiously awaiting the time when your production will again be in full swing.

We shall be pleased to establish contact between American radio servicemen's associations and our institution and would be thankful for any assistance or suggestions along these lines.

RADIO TECHNICIANS ASSOCIATION  
OF PALESTINE

W. Goldstein, Sec'y; Tel-Aviv,  
Palestine

RADIO-CRAFT for JANUARY, 1947



1907-1947

We honor you, Dr. Lee de Forest on the occasion of the 40th Anniversary of your vacuum tube, the historic audion.

## OSCILLOSCOPE FOUNDATION KIT

5 INCH

Consisting of Case, Chassis, two shelves (right & left), tube shield and bracket, front panel, screen window frame, handle, plastic window socket, with 5CP1 Cathode Ray tube—Special



**\$18.95**

2x2 Tube ..... \$1.00  
Socket for 2x2 Tube ..... .25  
H.V. Condenser .5 Mfd 2000 V 1.95  
KIT, without Cathode Ray tube 11.95  
5CP1 Cathode Ray tube only ... 7.40  
Tube shield and bracket only ... 1.98

Highbridge Radio-Television  
and Appliance Co.

340 CANAL STREET NEW YORK 13, N. Y.

## Check Pin Connections & Tube Data Instantly!

Two new and amazingly handy slide rules tell you at once the location and nature of pin connections, filament voltage, filament current, and uses for 176 radio tubes. Radio or electronic engineers, servicemen, students can't afford to be without these pocket-sized time-savers. SEND \$1.00 IN CASH OR MONEY ORDER TODAY and receive both prepaid by return mail. Your money back if not satisfied.

AT YOUR DEALERS

HARRY LANGSAM,  
12 S. 12th Street, Phila. 7, Pa.  
 I enclose \$1.00. Please send both Radio Tube Pin Data Rules.  
Name .....  
Address .....  
City ..... State .....

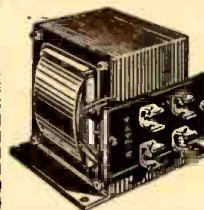

## THORDARSON 6.3 Volt Filament TRANSFORMERS

115 V., 50/60 Cy. Primary, 6.3 Volts at 10 Amps. Sec.

Leads brought out on an engraved bakelite panel—Wt. 5 lbs. Size 3 x 3 x 3 inches. With mounting brackets. Suitable for filament supply, battery charges, "A" supplies, pinball machines, bell-ringers, toys, etc.

3 to a carton—no less than 3 sold PRICE \$1.50

Lots of 12, each ..... \$1.25

AUDIO SALES CO.

11 WARREN ST. NEW YORK 7, N. Y.

## Do you need BINDING POSTS?



The XL PUSH POST with its Spring Action assures Constant Contact and quick connection.

Manufactured in All Aluminum Type M at 12c each.

Aluminum Body, Bakelite Top Type B1 at 15c each.

Types CP or NP, ALL BRASS—STAINLESS STEEL SPRING & PIN. PROVEN by 240 HR. SALT SPRAY TEST as NON-CORROSIVE at 28c each.

Manufacturers and Dealers Liberal Discounts

X. L. RADIO LABORATORIES  
420 West Chicago Ave., Chicago 10, Ill.



# MILO

Your "Q" for Quality

## FAMOUS NAMES

### HAMMARLUND

SP400-X SUPER PRO

This is the new model which covers a continuous range in 5 steps from .54 to 30 mc. Complete with Speaker. **\$347.25**

### HAMMARLUND HQ129-X

Frequencies cover .54 to 31 mc. in 6 steps. Complete with Speaker. **\$173.25**

### NATIONAL RECEIVERS

HBO 5TA, complete with Power Supply, Speaker and Coils (1.7-4.0; 3.5-7.3; 7.0-14.4; 14.0-30Mc). Additional coils available. **\$306.70**

NC 2-40D Complete with Speaker **\$241.44**

NC 46 Complete with Speaker **\$107.40**

### Federal Selenium Rectifiers

6 to 49 **99c Ea.**

1 to 5 **\$1.09 Ea.**

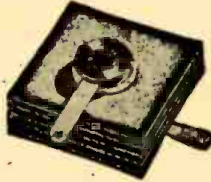

Quotations on larger quantities gladly furnished.

- for:
- \*CONSOLE RADIOS
  - \*AC-DC PORTABLES
  - \*VIBRATOR POWER SUPPLIES
  - \*INTERCOM POWER SUPPLIES
  - \*REPLACES 29 TYPES RECT. TUBES

### FEATURES

REPLACE TUBE and SOCKET; REQUIRE LESS SPACE; FACILITATE SMALLER CABINET DESIGN; PROLONG LIFE OF SET; GIVE IMMEDIATE RECTIFICATION

Schematic Application with every order.

### TALK-A-PHONE

LP-110 SUPER SELECTIVE SYSTEMS

The LP-110 System is made up exclusively of Master Stations. With this system any station can call any other station in the system and in addition a number of two-way conversations can be carried on at one time. You can begin with 2 Masters and add up to a total of 10 in the LP-110 System.

Each Master **\$26.50**

Milo has complete stocks of nationally known IRC, AEROVOX, B & W, NEWCOMB, THOR-DARSON, MEISSNER, TUNGSO, WESTON, SUPREME, NATIONAL, SNC TRANSFORMERS, etc.

If not rated, 20% with order, balance C.O.D.

Dept. C

# MILO



Radio and Electronics Corp.

200 Greenwich St., N. Y. 7, N. Y.

BEekman 3-2980-1

Export Div.: WESTERN INTERNATIONAL  
168 Washington St., N.Y. 6, N.Y.

## INDEX TO ADVERTISERS

Adson Radio .....	123	Langsam, Harry .....	141
Bass & Weber Co., Inc. ....	133	Leco Engineering Co. ....	130, 132
Algeradio Electronics Co. ....	108	Buchanan-Thomas Advertising	
Allied Radio Corporation .....	104	Leads Radio Company .....	122
Henry H. Teplitz Advertising		Bass & Weber Co., Inc. ....	132
Almo Radio Co. ....	104	Leotone Radio Corp. ....	132
E. L. Brown Co. ....	137	Altomari Advertising Agency	
American Technical Society .....	16	Liberty Sales Company .....	120
Reincke-Ellis-Younggreen & Finn		Sternfield-Godley, Inc. ....	137
American Television Institute .....	125	Lifetime Sound Equipment Co. ....	137
Turner Advertising Agency		The Miller Agency Co. ....	139
Amplifier Corporation of America		Lyell Hardware Company .....	139
Sternfield-Godley, Inc. ....	119	McGraw-Hill Book Company .....	143
Arrow Sales, Inc. ....	132	McMurdo Silver Company, Inc. ....	15
Sander Rodkin Adv. Agency		Edward Owen & Co. ....	127
Audel Publishers .....	141	Magna Metal Products .....	127
Grant & Wadsworth		Equity Adv. Agency	
Audio Sales Company .....	76	Mallory & Co., Inc., P.R. ....	Inside Back Cover
Bass & Weber Co., Inc. ....	130	Aitkin-Kynett Company	
Bell Telephone Labs .....	139	Maritime Switchboard .....	116
N. W. Ayer & Son		Metropolitan Electronic & Instrument Co. ....	104
Best Vibrator Company .....	118	Bass & Weber Co., Inc. ....	134
Brooks & Assoc., George		Midwest Radio Co. ....	142
The Schram Advertising Company		Savage & Talley	
Buffalo Radio Supply .....	128	Milo Radio & Electronics Corp. ....	102, 103
International Advertising Ag.		Burke and Wayburn Advertising Co. ....	78
Burstein-Applebee Co. ....	125	Murray Hill Books, Inc. ....	123
Frank E. Whalen Adv. Co.		Harry P. Bridge Advertising	
Cambridge Electronics Corp. ....	125	National Company, Inc. ....	123
C. F. Cannon Co. ....	93	Graydon Smith & Co. ....	139
M. J. Werner Adv.		National Plans Co. ....	1
Capitol Radio Engineering Institute		National Radio Distributors	
Henry J. Kaufman & Associates		Burke & Wayburn Advertising Agency	
Cleveland Institute of Radio Electronics ..	107, 109	National Radio Institute	
Kenneth Kolpein		Van Sant, Dugdale & Co. ....	13
Communications Equipment Co. ....	97	National Schools	
Borough Advertising Co.		The Mayers Co. ....	2
Concord Radio Corp. ....	98	National Union Radio Corp.	
E. H. Brown Advertising Ag.		Hutchins Advertising Co.	
Constant Electric .....	131	New York Technical Institute of N. J. ....	74, 75
Coyne Electrical School .....	79, 129, 130	Schwab & Beatty, Inc. ....	12
Phil Gordon Advertising Agency		Newark Electric Co., Inc. ....	138
Coyne Electrical School .....	128	The Charles Brunelle Co. ....	127
McJunkin Advertising Agency		Newark Surplus Materials Co. ....	113
Crabtree Wholesale Radio		Wm. N. Scheer Advertising Agency	
DeForest's Training Institute		Newcomb Audio Products Company	
Lauesen & Salomon		Stevens Hall Advertising	
Duston and Associates, Merle		Niagara Radio Supply .....	120
D. & H. Distributing Co. ....	107	Burke and Wayburn Advertising Agency	
Editors and Engineers, Ltd.		Ohmeyer Engineering Labs. ....	92
Electro Impulse Labs. ....	100	Ohmite Mfg. Co. ....	111
Electronic Measurements Corp.		Fensholt Co. ....	101
J. L. Purnies & Assoc.		Olson Radio Warehouse	
Electronic Parts, Inc. ....	132, 133	Jessop Advertising Co.	
Campbell & Reynolds		Onan & Sons, D. W., Inc. ....	140
Erie Supply Company .....	95	Graves and Associates	
Esse Radio Co. ....	133	Opportunity Adlets .....	131
Gary A. Ruben		Pa-Kette Radio Co. ....	142
Federated Purchaser .....	106	Arrow Advertising Agency	
Bergman-Jarrett Company		Phelps Publishing Co. ....	130
Feller Engineering Company		Precision Electronics, Ins. ....	129
George Brodsky, Advertising		Campbell & Reynolds	
Galvin Manufacturing Company		Quam Nichols	
Gourfain-Cobb Advertising Agency		Triangle Advertising Agency Inc.	
General Cement Manufacturing Company			
Turner Advertising Agency			
General Electric Company .....	124		
Maxon, Inc. ....	139		
General Test Equipment Company			
Suzanne Hayman			
Greenwich Sales Company .....	135		
Bass & Weber Co., Inc. ....	6		
Guardian Electric Manufacturing Co. ....	Inside Front Cover		
Kennedy & Co. ....	105		
Hallcrafters Company .....	117		
Burton Browne, Inc. ....	130, 141		
Harrison Radio Company .....	139		
Altomari Advertising Agency			
Hershel Radio Co. ....	96		
Hugh Allen Advertising			
Highbridge Radio-Television & Appliance			
Co. ....	120		
Burke & Wayburn Advertising Agency			
Hollander Radio Supply Co. ....	125		
Turner Advertising Agency			
Hoover Industries .....	126		
Hyatt Eby			
Hudson Specialties .....	129		
Illinois Condenser Company			
Roy D. Zeff & Associates			
Instructograph Company .....	124		
Turner Advertising Agency			
Jensen Industries, Inc. ....	129		
Allan D. Parsons Advertising			
J. F. D. Manufacturing Company			
Bergman-Jarrett Company			
J. M. P. Manufacturing Co. ....	138		
K-Jax .....	110		
Lafayette Radio Co. ....	138		
Reiss Advertising Agency			
Lake Radio Sales Co. ....	129		
Sender Rodkin Adv. Agency			

### RADIO SCHOOL DIRECTORY

(See page 144)

American Radio Institute	
Sternfield-Godley, Inc.	
Candler System Co.	
Rand-Ries Adv., Inc.	
Commercial Radio Institute	
Electronics Institute, Inc.	
Chester Miller	
Gotham Radio Institute	
Halpern Advertising Agency	
Lincoln Engineering School	
Buchanan-Thomas Adv.	
Melville Radio Institute	
Seidell Adv.	
RCA Institutes	
Tri-State College	
Clem J. Steigmeyer Adv.	
United Radio Television	
Western Radio Television Institute	
Y.M.C.A.	
Radcraft Publications .....	99, 135
Radio Corporation of America	Back Cover
J. Walter Thompson Co.	
Radio Center .....	116
Radio Dealers Supply Co. ....	137
Radio Distributing Co. ....	127
Radio Electric Service Co. ....	94
David Zibman Adv.	
Radio Kits Co. ....	126
Hamburger Agency	
Radio Parts Co. ....	100
Sydney S. Lovitt Advertising	

**PRODUCTION** in our plant includes the typesetting, presswork, binding and mailing and shipping of your

### RADIO-CRAFT

Congratulations to the Publisher as he salutes DR. LEE DE FOREST in this issue

**PHELPS PUBLISHING COMPANY, Springfield, Massachusetts**



Radiolab Publishing Co.	117
Bass & Weber Co., Inc.	107
Radio Specialties Co.	135
Radio Tube Service Co., Inc.	138
Radionic Equipment Co.	126
Bass & Weber Co., Inc.	129
Radolek Company	140
Turner Co.	128
Randolph Radio	135
Risco Sales Co.	129
Diener & Dorskind	140
Robco Corporation	128
Freiwald-Coleman Advertising	135
Rosicrucians, The	135
Richard Jorgensen	3
Sams, Howard W., & Co., Inc.	3
Aitken-Kynett Co.	127
Scenic Radio & Electronics Co.	127
Sprague Products Co.	14
Harry P. Bridge Co.	9
Sprayberry Academy of Radio	9
Harry P. Bridge Co.	135
Stahl, Michael	131
Bass & Weber Co., Inc.	131
Star Measurements Co.	136
Altomari Advertising Agency, Inc.	136
Sterling Electronic Co.	91
Sunbury Engineering Works	91
Superior Instruments	94
Bass & Weber Advertising Agency	94
Supreme Instruments Corp.	119
O'Callaghan Advertising Agency	73
Supreme Publications	123
Henry H. Teplitz Advertising	7
Supreme Transmitter Corp.	7
Surplus Radio, Inc.	121
Bass & Weber Co., Inc.	121
Sylvania Electric Products, Inc.	128
Newell-Emmett Co.	127
"TAB" Technical Apparatus Builders	127
Bass & Weber Co., Inc.	131
Talk-A-Phone	123
Dwight M. Blish Advertising	134
Taylor Tubes, Inc.	77
Turner Advertising Agency	139
Terminal Radio Co.	4
Regent Adv. Agency	8
Terry, Jay	136
Thor Electronics	58
Paul J. Basinger Advertising	59
Triplett Electrical Instrument Co.	80
Western Adv. Ag.	141
Trutone Products Co.	141
Julius J. Rowen Company	141
Tung-Sol Lamp Works, Inc.	141
E. M. Freyhardt Associates, Inc.	141
Turner Co.	141
W. D. Lyon Co.	141
Variety Electric Co.	141
Bass & Weber Co., Inc.	141
Vision Research Laboratories	141
Abner Robins Advertising	141
Wells Sales, Inc.	141
Turner Advertising Agency	141
Weston Electrical Instrument Co.	141
E. M. Bedford Co.	141
X.L. Radio Laboratories	141

## BOOK REVIEWS

**RADIO'S CONQUEST OF SPACE, The Experimental Rise in Radio Communication, by Donald McNicol (past president, The Institute of Radio Engineers). Published by Murray Hill Books, Inc. Stiff cloth covers, 5½ x 8½ inches, 374 pages. Price \$4.00.**

Here is radio history on the march—written by an engineer who grew up with it. The author is to be congratulated on the complete manner in which he has covered the field of radio invention and inventors. In this book one has an opportunity to learn something about the real background of radio invention. What were some of the early experiments that led to the invention of the vacuum tube detector and amplifier . . . and who were the investigators?

Mr. McNicol tells all this—for the first time in many instances, as this "background" is frequently omitted by writers. His historical record of names, places and inventions is surprisingly detailed and shows that a prodigious amount of research was performed in the preparation of this work.

A refreshing feature of the book is that the author does not hesitate to express an opinion on some of the important inventions; some unusually interesting "sidelights" on the claims and opinions of inventors are included.

The copious section on the Fleming valve and the de Forest audion comes at a happy moment, when the fortieth anniversary of de Forest's invention of the three-electrode tube is being celebrated. A complete index by names as well as by inventions is included in the book.—*H.W.S.*

## NOW—A REALLY HIGH-POWERED— Radio Engineering Library

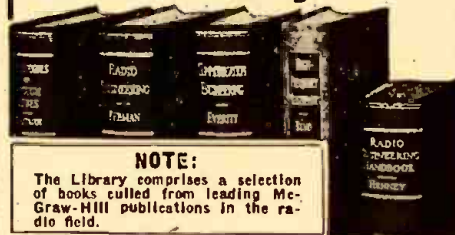

**NOTE:**  
The Library comprises a selection of books culled from leading McGraw-Hill publications in the radio field.

- especially selected by radio specialists of McGraw-Hill publications
- to give most complete, dependable coverage of facts needed by all whose fields are grounded on radio fundamentals
- available at a special price and terms

THESE books cover circuit phenomena, tube theory, networks, measurements, and other subjects—give specialized treatments of all fields of practical design and application. They are books of recognized position in the literature—books you will refer to and be referred to often. If you are a practical designer, researcher or engineer in any field based on radio, you want these books for the help they give in hundreds of problems throughout the whole field of radio engineering.

**5 VOLUMES, 3319 PAGES, 2289 ILLUSTRATIONS**

1. Eastman's FUNDAMENTALS OF VACUUM TUBES
2. Terman's RADIO ENGINEERING
3. Everitt's COMMUNICATION ENGINEERING
4. Hund's HIGH FREQUENCY MEASUREMENTS
5. Henney's RADIO ENGINEERING HANDBOOK

10 days' examination. Easy terms. Special price under this offer less than books bought separately. Add these standard works to your library now; pay small monthly installments, while you use the books.

**10 DAYS' FREE EXAMINATION—SEND COUPON**

McGraw-Hill Book Co., 330 W. 42nd St., New York 18

Send me Radio Engineering Library, 5 vols., for 10 days' examination on approval. In 10 days I will send \$2.50, plus few cents postage, and \$4.00 monthly till \$26.50 is paid, or return books postpaid. (We pay postage on orders accompanied by remittance of first installment.)

Name .....

Address .....

City and State .....

Company .....

Position .....

RC 1-47

### RADIO TERM ILLUSTRATED



Suggested by:  
Russell Simpson, Lansdale, Pa.

A Good Detector.

## SURPLUS SPECIALS

Western Electric dry disc rectifier replaces rectifier tubes in portable radios. 150r 60ma	70c
3" cathoda ray radar scopes 115v. 400 cps. brand new	\$25.00
RCA beat frequency oscillator. 30-15,000 cps. model 154	\$40.00
Lending Meter, with two 200 microamps movements. 3½ dia.	\$5.00
5" cathode ray tubes 5BP1	\$7.50
6 volt filament transformer	85c
6 volt power transformer	\$1.50
4 mfd 600VV round can. oil filled	60c
.05 mfd 1500 WV. oil filled	15c
.001 silver mica	15 for \$1.00
.01 mica and .0175 mica. 1200 WV	15c
AC. DC 2 band 5 tube radio. 5" speaker. beautiful two tone bakelite cabinet. OPA retail \$36.00, net	\$24.95

**ELECTRO IMPULSE LABS. Shrewsbury, N. J.**

An error in Radio Data Sheet 340 on page 35 of the October issue shows the control grids of the lower pair of 6K6's connected to the high-voltage bus. The high-voltage lead from the speaker socket is connected to the screens of the right-hand pair of 6K6's and to nothing else in the set. To correct the drawing, the high-voltage bus connection to the control grids should be made to the speaker socket high-voltage lead.

We thank Mr. Horace M. Love, Jr., of Pittsburgh for this correction.



# RADIO SCHOOL DIRECTORY

PREPARE NOW FOR SKILLED JOBS IN RADIO AND ELECTRONICS

## CAREERS in RADIO

**INTENSIVE COURSES**—Thorough, technical education for progressive men and women.

1. **RADIO TECHNICIAN**—The MRI General Course. Includes F.M. & Television. Prepares For FCC Broadcast Licenses.
2. **RADIO & TELEVISION SERVICING**—Prepares for employment as Repairman on Standard Broadcast, F.M. & Television Receivers.
3. **RADIO COMMUNICATIONS**—Prepares for FCC Operators' License. Leads to position as Merchant Marine or Flight Radio Officer; Commercial Operator.
4. **FUNDAMENTAL RADIO MATHEMATICS**—The MRI Preparatory Course. Required pre-training for students lacking a basic mathematical background.

**MELVILLE RADIO INSTITUTE**  
45 W. 45th St., N. Y. 19, BR 9-5080  
"The Radio School Managed By Radio Men"

Licensed by the State of New York

**MELVILLE RADIO INSTITUTE**  
45 West 45th St., New York 19, N. Y.  
GENTLEMEN: RC

Send me **FREE** information about your school.

Name.....

Address.....

MAIL THIS COUPON NOW

**RADIO ENGINEERING!**

VETERANS can complete work here in shortest possible time. Courses also in Civil, Electrical, Mechanical, Chemical, Aeronautical Engineering; Business Administration, Accounting, Secretarial Science. 63rd year. Enter Jan., Mar., June, Sept. School now filled to capacity. No applications can be accepted until further notice.

**TRI-STATE COLLEGE** 2417 College Ave. ANGOLA INDIANA

**RADIO COURSES**

- RADIO OPERATING
- RADIO SERVICING — ELECTRONICS
- REFRIGERATION SERVICING

Personal Counselling Services for Veterans  
Write for Latest Trade & Technical Catalog

**Y.M.C.A. TRADE & TECHNICAL SCHOOLS**  
4 W. 64th Street New York City

**ELECTRONICS**

Electronic Technician Training Course. Qualify for Radio Communication (Commercial Government License); Radio Repair Service; or be an Industrial Electronic Technician. Register now for new classes starting every four weeks. Approved under G. I. Bill of Rights. Residence day and evening school. Write to

**ELECTRONICS INSTITUTE, INC.**  
21 HENRY, DETROIT 1, MICH.

Correspondence Courses in **RADIO and ELECTRICAL ENGINEERING**

**ELECTRICAL ENGINEERING** Get good grasp of wide electrical field. Prepare yourself, at Low Cost, for secure future. Modern, simplified, you can understand quickly.

**RADIO ENGINEERING** Extra fine course in radio, public address, photo-electric work. Trains you to be super-service man, real vacuum tube technician. Servicemen needed badly. Diploma on completion. Tuition \$25, either course. Deferred payment plan. Get copies of school catalogs, student magazines, complete details. **SEND NOW!**

**FREE**

**LINCOLN ENGINEERING SCHOOL** Box 933C-95 Lincoln, Nebr.

**RADIO — FM — TELEVISION**

- Small classes
- Top notch instruction and equipment
- Licensed by State of New York
- Approved for Veterans

WRITE FOR BULLETIN

**Gotham Radio Institute**  
3534 Broadway (Cor. 145 St.) New York, N. Y. Ed 4-0902

**RCA INSTITUTES, Inc.**

Offer thorough training courses in all technical phases of **Radio and Television**

DAYS—EVENINGS WEEKLY RATES

**VETERANS:** RCA Institutes is approved under G. I. Bill of Rights

For Free Catalog Write Dept. RC-47

**RCA INSTITUTES, Inc.**  
A Radio Corporation of America Service  
75 VARICK STREET NEW YORK 13, N. Y.

**COMMERCIAL RADIO INSTITUTE**

A radio training center for twenty-six years.

**RESIDENT COURSES ONLY**

Broadcast, Service, Aeronautical, Television and Marine telegraphy classes now forming. Literature upon request. Veteran training. Classes now forming for mid-year term, Feb. 1st. Entrance exam. Jan. 13.

Dept. C. 38 West Biddle St., Baltimore 1, Md.

**LEARN RAPID RADIO SERVICING**

Send for Free Information: "3 Ways to Learn Radio." Approved for Training Veterans.

**WESTERN RADIO INSTITUTE**  
1457 Glenarm, Denver 2, Colo.

**LEARN RADIO—TELEVISION—FM**

Complete courses in all phases given in both day and evening classes.

Veterans accepted under G.I. bill

**United Radio Television Institute**  
225 Halsey Street Newark 2, N. J.

**RADIO**

RADIO Technician and Radio Communications courses. Register now for new classes starting first MONDAY of each month. Day and Evening Classes.

**AMERICAN RADIO INSTITUTE**  
101 West 63rd St., New York 23, N. Y.  
APPROVED UNDER G.I. BILL OF RIGHTS.

**SENDING SPEED**

Be a "key" man. Learn how to send and receive messages in code by telegraph and radio. Commerce needs thousands of men for jobs. Good pay, adventure, interesting work. Learn at home quickly through famous Candler System. Write for **FREE BOOK**.

**CANDLER SYSTEM CO.**  
Dept. 3-A, Box 928, Denver 1, Colo., U.S.A.

## BOOK REVIEWS

(Continued from page 143)

**RADIO TUBE VADE-MECUM**, by P. H. Brans. Distributed in the United States by Editors and Engineers (Santa Barbara, Calif.). Heavy paper covers, 7 1/4 by 10 1/2 inches, 231 pages. Price \$2.50.

The 6th edition of "the most complete and authoritative set of tube data in existence" has been expanded as well as brought up to date. Besides the six tables, giving characteristics of all European and American valves, there are two new sections. One of these is a revision of last year's "Service Valves" and is called "Allied Army Tubes." The other—completely new—is titled "German and Italian Army Tubes."

Supplements are to be supplied quarterly to all subscribers to the 1946 edition, according to the publisher.

The book, like last year's edition, is published in four languages, Dutch, French, English and German.

**RELAY ENGINEERING**, by Charles A. Packard (Chief Engineer, Struthers-Dunn). Published by Struthers-Dunn, Inc. Flexible leatherette covers, 4 1/2 by 6 1/2 inches, 640 pages. Price \$3.00.

Strictly a "house" book, which describes the use of the company's equipment in various applications, this little work is so fundamental and detailed as to be "a reference book to guide engineers and others in the selection and use of electromagnetic relays," quite irrespective of brand name.

Chapters are headed: Introduction, Definitions, Selection of Relay for Specific Task, Applications and Circuits, Typical Relays, Relay Components, Auxiliary Equipment, Relay Installation and Service, Standards, Bibliography and Appendix.

**MALLORY RADIO SERVICE ENCYCLOPEDIA** (Fifth Edition); compiled and published by P. R. Mallory and Co., Inc. Heavy paper covers, 8 1/2 x 10 1/4 inches, 479 pages. Price \$1.50.

This, the fifth edition of MYE, the first of the series to be printed in over four years, contains much useful information on almost all pre-war radios.

From a convenient tabular listing of radio sets by manufacturer and model number, it is possible to get the stock numbers of replacements for resistive controls, electrolytic condensers and vibrators for automobile, farm and home and portable radios.

Key numbers, for each model radio, refer to basic circuit diagrams which show how the replacement parts are connected into the circuit. A complete tube complement for each set is given so that it is often possible to identify a model by referring to the manufacturer's tube complement for the different models. Also included in this listing is the intermediate frequency of super-heterodyne radios.



# Mallory Offers 12 Clutch Type Controls for Use in Auto Receivers



**M**ALLORY offers the widest range of resistance values in clutch type controls to fit every need. Four different values are available in the Universal Midget line (100M ohms, 250M ohms, 500M ohms, 1 megohm), and eight values in popular combinations of overall and tap resistances in our Tapped Midget line.

Add these to the Plug-In Shafts you see at the right, and you can replace original controls in any auto set you name—not merely replace them but *duplicate them mechanically and electrically*. Get the complete story from your Mallory distributor.

You Expect More...  
and Get More...  
from Mallory

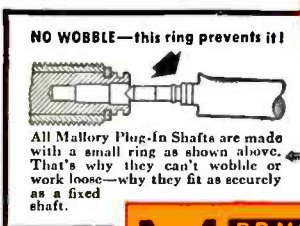

INSIST ON  
MALLORY—THE  
COMPLETE  
CONTROL  
LINE

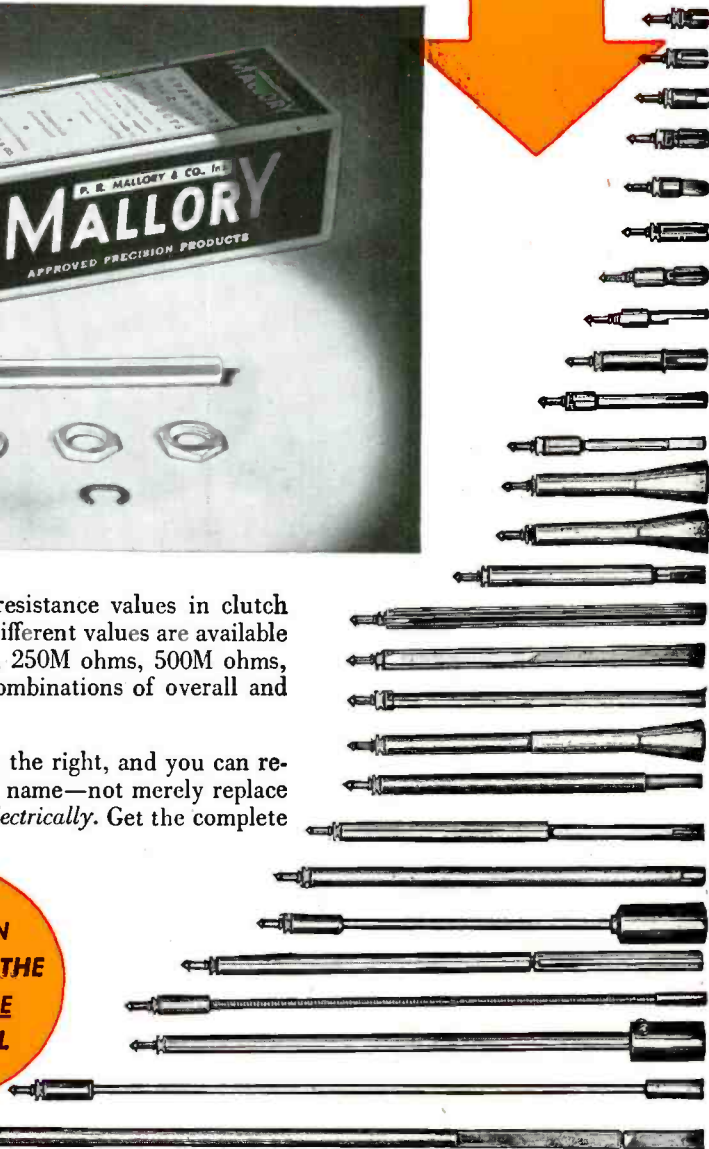

P. R. MALLORY & CO. Inc.  
**MALLORY**

VIBRATORS . . . VIBRAPACKS\* . . . CAPACITORS . . . VOLUME CONTROLS . . . SWITCHES . . . RESISTORS . . . FILTERS . . . RECTIFIERS . . . POWER SUPPLIES. ALSO MALLORY® DRY BATTERIES, THE ORIGINAL MERCURY BATTERIES.  
\*Reg. U. S. Pat. Off.

**APPROVED PRECISION PRODUCTS**

P. R. MALLORY & CO., Inc., INDIANAPOLIS 6, INDIANA



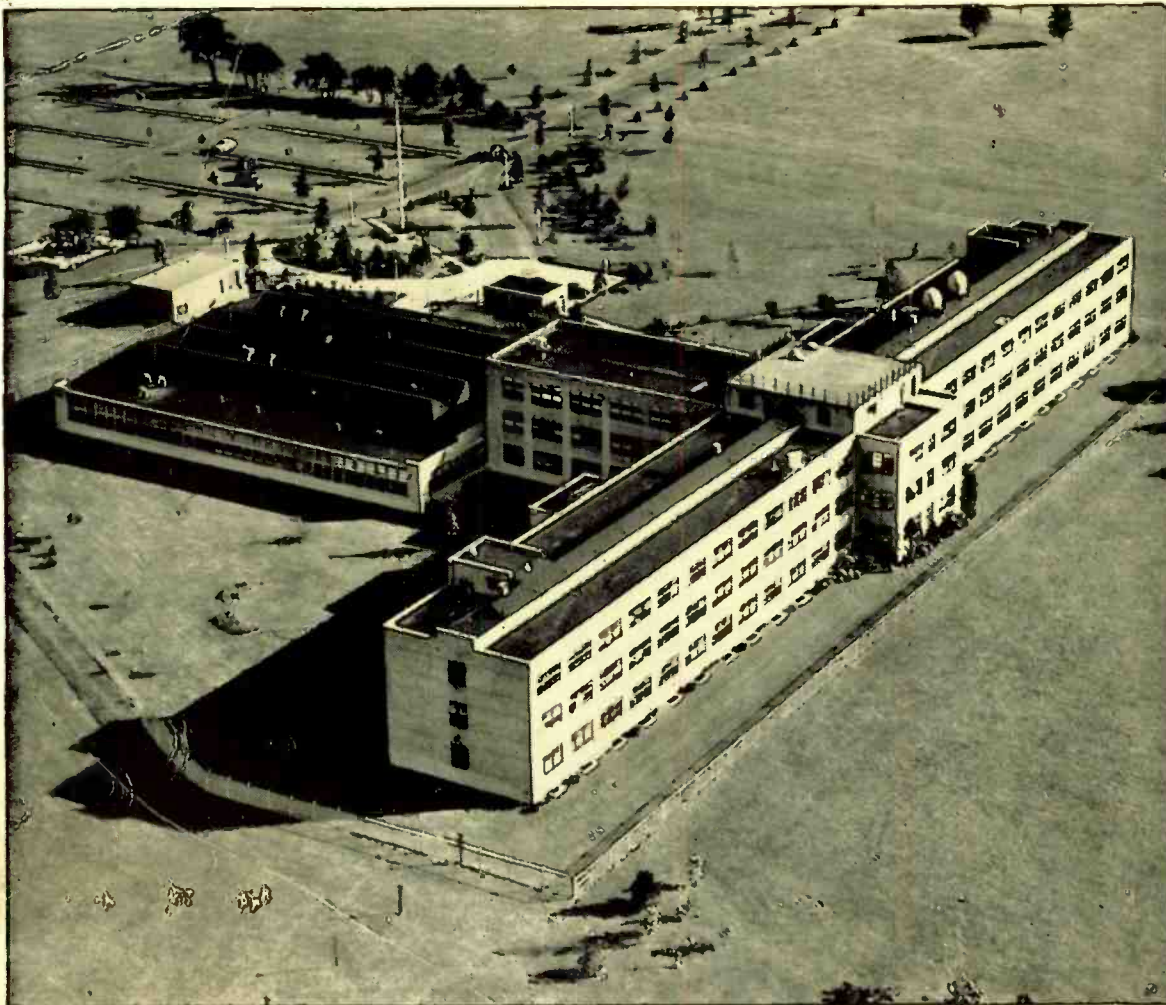

## **RCA Laboratories—Center of Radio and Electronic Research**

RCA Laboratories at Princeton, N. J., are far more than one of the most modern and best-equipped laboratories ever built. It is a community of scientists, research men and technicians—each a top man in his field—each working with the other—contributing wherever and whenever his specialized knowledge will help.

It is a “university of ideas”—where visions are graduated as practical realities... where human wants are fulfilled through the creation of new products and processes, new services and markets.

It is a birthplace of scientific, industrial and social progress for the entire nation.

It is the reason why anything bearing the letters “RCA”—from a radio tube to your television receiver of tomorrow—is one of the finest instruments of its kind that science has yet achieved.

For just as RCA Victor television receivers, radios, or Victrola\* radio-phonographs are stamped by the RCA emblem, so do the products themselves bear a stamp of experience and research that gives RCA pre-eminence in radio and electronics.

*Radio Corporation of America, RCA Building, Radio City, New York 20. Listen to The RCA Show, Sundays, 2:00 P. M., Eastern Time, over the NBC network.*

### **PIONEERING**

Scientists and research men who work in RCA Laboratories made many vital contributions in helping to win the war through application of radio, electronic, radar and television techniques. Their skills now are devoted to peacetime applications of these sciences.

At RCA Laboratories the electron microscope, radar, all-electronic television (featuring the projection system for the home) and many other new instruments of radio, including hundreds of new electron tubes, were developed to improve and to extend the services of radio around the world.



**RADIO CORPORATION of AMERICA**

\*Victrola T. M. Reg. U. S. Pat. Off.